



Tool drives

- Highlights from the PFERD range 3
- General information 4
- What the machine designations mean 6



Robot spindles for stationary applications

- Straight grinder 9
- Angle grinder with collet 12
- Angle grinder with threaded spindle 13



Air grinders

- Straight grinder 14
- Angle grinder with collet 33
- Angle grinder with threaded spindle 36
- Angle grinder with hexagon mounting 39
- Belt grinders and belt arms 40
- Belt grinder attachment arm group 1 41
- Belt grinder attachment arm group 2 42
- Belt grinder attachment arm group 3 45
- Filing machines 46
- Marking pens 47
- Fittings 48



RCK drive systems

- RCK control device 50
- Handpieces for RCK system 50
- Accessories for RCK system 52



MIM drive systems

- Micro motor system 55
- Micro motor handpieces 55
- Accessories for micro motor systems 57



Electric grinders

- Straight grinder 58
- Angle grinder 59
- EDGE FINISH system for work on edges 61
- Burnishing machine 61
- Belt grinders and belt arms 62
- Belt grinder attachment arm group 4 63
- Pipe belt grinder 63



Drive systems with DIN 10/ DIN 15

- Flexible shaft drives – EL motors for flexible shafts and accessories 66
- Flexible shaft drives for Record Universal Motor and accessories 67
- Flexible shaft drives for Mini-Mammoth Electronic and accessories 68
- Flexible shaft drives for Mammoth Electronic and accessories 68
- Flexible shaft drives for Maxi-Mammoth Electronic and accessories 71
- Flexible shaft 4 and handpieces 72
- Flexible shaft 6 and handpieces 73
- Flexible shaft 6 Z and handpieces 74
- Flexible shaft 7 and handpieces 76
- Flexible shaft 10 and handpieces 77
- Flexible shaft 12 and handpieces 78
- Remote switch for flexible shafts and accessories 79
- Special flexible shafts for inner grinding of pipes and accessories 80
- Handpieces and accessories 81
- Angle drives and accessories 85
- Belt sanders 86
- Handpieces for rigid extensions 87
- Rigid extensions STV 88
- Flexible shaft adapter 90
- DL motors DIN 10 for rigid extensions 91
- EL motors DIN 10 for rigid extensions 92



Accessories for tool drives

- Extensions 93
- Collets 94
- Reducing collets and adapter 97
- Arbor 97
- Key 98
- Maintenance accessories 99
- Clamping flanges 101

Robot spindle PGAS 4/52 RS

PFERD robot spindles are manufactured according to the most stringent quality criteria and the latest technological standards, and are ideal for stationary applications in robot cells and machine tools and for installation in transfer lines. Scan the QR code to find out more about PFERD's range of robot spindles.



Advantages:

- High torque due to planetary gear.
- Very high concentricity in continuous use.
- Double spindle bearing for a longer tool life.

Air grinder PGAS 3/380 E-HV

With the PGAS 3/380 E-HV, PFERD offers an air grinder with an elastically mounted spindle for low-vibration working. It also guarantees a longer tool life, especially when using tungsten carbide burs. Scan the QR code to find out more about PFERD's range of air grinders.



Advantages:

- The compact design enables good accessibility.
- Dead man's switch using safety lever valve.

RCK drive system

The RCK drive system with stepless rotational speed regulation is an innovative solution that combines maximum productivity with significant ergonomic benefits. The system produces less noise and lower vibrations than conventional drives. In combination with the mobile control device and various handpieces, the system is particularly light, comfortable and flexible to use for operators. Scan the QR code to find out more about PFERD's RCK drive system.

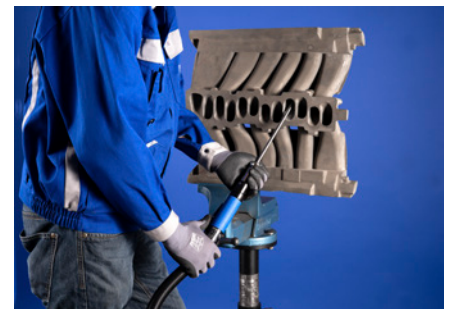


Advantages:

- Boosts productivity by up to 50% thanks to constant rotational speed.
- Comfortable, ergonomic working with fast, optimal results.
- Can be used with a battery for mobile use or a power supply unit, for a variety of industrial applications.

Air-power motor PMA 4/220 HV with DIN 10 for rigid extensions

The air grinder with DIN 10 connection can be used for all manner of applications with different rigid extensions. Scan the QR code to find out more about PFERD's range of air grinders with a DIN 10 connection.



Advantages:

- Very powerful with a compact shape.
- Safe working using dead man's switch.



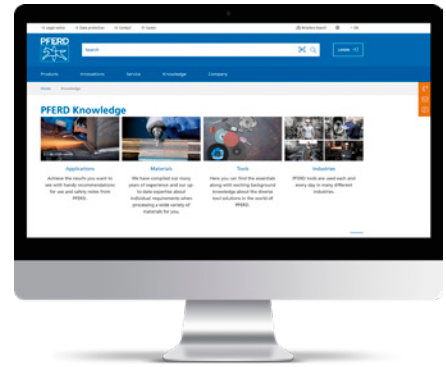
Tool drives

Highlights from the PFERD range



More expert information online

Scan the QR code to find out a wide range of tool and application knowledge relating to PFERD's high-quality tools and their huge variety of materials.



General information

The PFERD range includes tool drives for grinding, milling, brushing, cutting and polishing in manual applications as well as in robotic and semi-stationary applications. PFERD is one of only a few manufacturers that can offer a wide range of tools for work on surfaces and cutting of materials, as well as drives designed specifically for these tools, all from a single source.

The wide product range includes air and electric grinders as well as drive systems with DIN 10/ DIN 15 and thus offers the best solution for almost any working environment.

PFERD tool drives are characterized by their performance and durability. They are less prone to faults and comply with the latest technological standards.



Spare parts catalogue

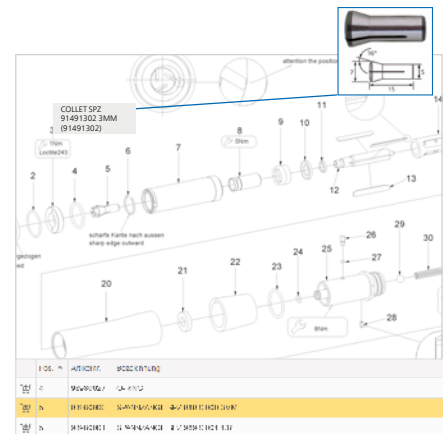
In our online spare parts catalogue, we have compiled all the information about every PFERD drive. Here you will find exploded drawings and other sketches as well as photos and ordering data for each individual spare part for our drives. With just a few clicks, you can select the required spare parts or spare parts kits, add them to your shopping cart and order them online directly from PFERD.

If you ever misplace the operating instructions, you can find them in our spare parts catalogue for download along with other documents such as CE declarations of conformity and illustrated DIY instructions for minor repairs.

Our clearly organized online spare parts catalogue can be found at spareparts.pferd.com.










In the information area you can see which documents are available for download.










Move your mouse over the different spare parts for your PFERD tool drive to see the exact product specifications. Clicking on the relevant code displays more information and a product image. In the lower section of the image, you have the option of adding the selected spare parts directly to the shopping cart and ordering them. Scan the QR code to access the online spare parts catalogue.












Explanation of pictograms used

General

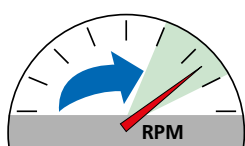
	Rotational speed
	Belt speed
	Power output
	Matching open-ended wrenches
	Matching hexagon socket wrenches
	Matching face pin spanners
	Matching Allen keys
Tool mounting	
	Clamping range
	Collet

	Stud bolt
	Centre hole
	Guard
	Suitable for disc diameter
	Suitable for grinding drum fitting
	Belt dimensions
Air grinders	
	Information on use – oil
	Can be used without oil
	Air pressure

	Air supply hose diameter
Electric grinders and flexible shaft drives	
	Voltage
	Frequency
	Protectively insulated in accordance with protection class II
	Protectively earthed in accordance with protection class I
	Safety transformer
	Safety extra-low voltage in accordance with protection class III
Flexible shafts	
	Drive-side shaft connection
	Handpiece-side sliding coupling

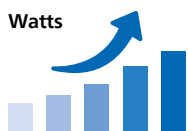
Criteria for selecting the optimum drive

An important prerequisite for cost-effective work is selecting the optimum tool. The appropriate drive is selected taking the following criteria into consideration:



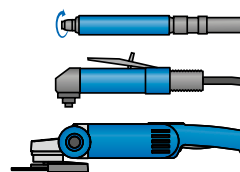
1. Rotational speed

The drive should always be selected according to the rotational speed and cutting speed recommendations for the tool. Refer to catalogue sections 2 to 8 and 10 for these recommendations.



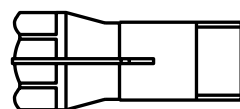
2. Power output

The drive's power output is the decisive factor for maintaining the rotational speed under load. The load is determined by the material to be machined, the cutting characteristics of the tool and the contact pressure.



3. Design, shape and size

Each type of application places specific demands on the design and size of the tool drive. The different designs can be used for various applications,



4. Tool mounting

Depending on the PFERD tool selected, different tool mountings are available, e.g. collets or threaded spindles. Matching collets are allocated to every drive. Please refer to the accessories for tool drives in this catalogue for an overview of collets and spindle extensions. If you have any further questions, your personal PFERD sales representative will be happy to help you.



Tool drives

What the machine designations mean



The PFERD machine designations are structured to provide information about the drive type, as well as designs, throttle types and tool mountings. They also enable you to quickly and easily select the right rotational speed and performance classes for the various machine types.

The following overview provides a concise summary:




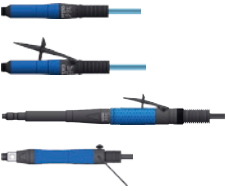














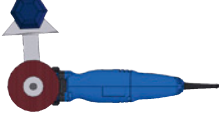
Figure	Description				Performance group	Rotational speed	Designs, throttle types, tool mountings
Robot spindles							
	P Pneumatic	G Straight grinder	T Turbine motor	S Collet	1 x 100 watts	1000 x 100 RPM	RS Robot spindle
	P Pneumatic	G Straight grinder	A Rear exhaust	S Collet	3 x 100 watts	370 x 100 RPM	RS Robot spindle LL Anti-clockwise
	P Pneumatic	W Angle grinder	A Rear exhaust	S Collet	4 x 100 watts	180 x 100 RPM	RS Robot spindle
Air grinders							
	P Pneumatic	G Straight grinder	A Rear exhaust	S Collet	2 x 100 watts	800 x 100 RPM	E Elastic bearing Z Two-handed M Medium length B Wide extension V Extended DV Ring throttle HV Lever throttle DS Instant start
	P Pneumatic	W Angle grinder	A Rear exhaust	S Collet	1 x 100 watts	800 x 100 RPM	DV Ring throttle HV Lever throttle HEX 3MM 3 mm hexagonal tool mounting
	P Pneumatic	B Belt grinder	A Rear exhaust		2 x 100 watts	200 x 100 RPM	HV Lever throttle oVA Without attachment arm
	P Pneumatic	F Filing machine			4 Stroke length mm	84 x 100 strokes per minute	SV Push-pull throttle HV Lever throttle
	MST Marking pen				32 x 1000 strokes per minute		DV Ring throttle F Needle gauge: fine






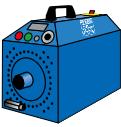



Figure	Description				Performance group	Rotational speed	Designs, throttle types, tool mountings
RCK drive system							
	RCK RCK	STG Control device			10 x 100 watts	800 x 100 RPM	
	RCK RCK	G Straight grinder	S Collet		3 x 100 watts	800 x 100 RPM	VS Extended spindle SP Keyless quick-mounting system
	RCK RCK	W Angle grinder	S Collet		3 x 100 watts	300 x 100 RPM	90° 90 degree angle handpiece
MIM drive system							
	MIM Micro motor	STG Control device	3 Version	S with switch	3 x 100 watts	800 x 100 RPM	
	MIM Micro motor	HA Straight handpiece		S with switch	3 x 100 watts	800 x 100 RPM	VS Extended spindle SP Keyless quick-mounting system 3 Incl. collet Ø in mm
	MIM Micro motor	WZ Angle handpiece		S with switch	3 x 100 watts	800 x 100 RPM	90° 90 degree angle handpiece S Collet 3 Incl. collet dia. in mm
Electric grinders							
	E Electric	G Straight grinder	ER Electronically regulated		8 x 100 watts	280 x 100 RPM	E Elastic bearing
	E Electric	B Belt grinder	ER Electronically regulated		8 x 100 watts	280 x 100 RPM	
	E Electric	B Belt grinder	ER Electronically regulated		12 x 100 watts	25 x 100 RPM	R Pipe belt grinder
	E Electric	W Angle grinder	ER Electronically regulated		17 x 100 watts	75 x 100 RPM	
	E Electric	S Burnishing machine	ER Electronically regulated		12 x 100 watts	25 x 100 RPM	



Tool drives

What the machine designations mean



Figure	Description			Performance group	Rotational speed	Designs, throttle types, tool mountings
DIN 10/DIN 15 drive systems						
	E Electric	M Motor	ER Electronically regulated	8 x 100 watts	280 x 100 RPM	BW Flexible shaft
	R Record	U Universal motor	ER Electronically regulated	8 x 100 watts	180 x 100 RPM	
	MME Mini-Mammoth electronic		W Alternating current	11 x 100 watts	120 x 100 RPM	
	ME Mammoth electronic		W Alternating current	18 x 100 watts	240 x 100 RPM	
	MME Maxi-Mammoth electronic			40 x 100 watts	150 x 100 RPM	
	P Pneumatic	M Motor	A Rear exhaust	10 x 100 watts	120 x 100 RPM	HV Lever throttle
	E Electric	M Motor	ER Electronically regulated	8 x 100 watts	280 x 100 RPM	





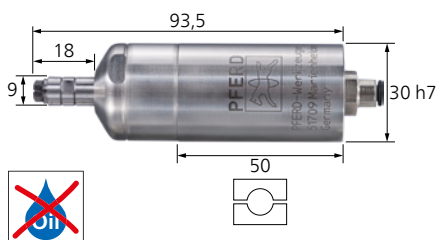
Custom-made products

If you cannot find the solution for your particular application in our comprehensive product range, we are happy to produce robot spindles to meet your preferences and requirements. Our sales representatives and technical advisers will be happy to assist you in analyzing your task. Simply contact us to arrange an appointment. You can find our worldwide sales office addresses at www.pferd.com.

On request, robot spindles can be supplied with deflection, in a reversible design, with clockwise or anti-clockwise rotation and with a tool change system.



Straight grinder



PGTS 1/1000 RS

Robot spindle manufactured according to the most stringent quality criteria and the latest technological standards with clockwise rotation and exhaust directed to the front. Suitable for stationary applications in robot cells and machine tools and for installation in transfer lines.

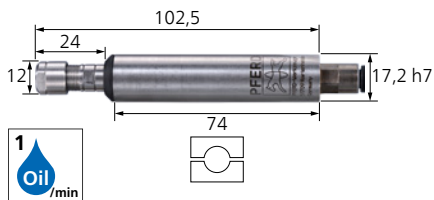
Contents:

Quick coupling (BK 4 mm - 1/4"), 3 mm collet (collet group 15), 2 keys (DM SW 6/8 mm).

Special features:

- Stainless steel collet mounting.
- Very high concentricity in continuous use.

RPM	Power output [watts]	Air consumption at idle [m³/min]	Air consumption under load [m³/min]	Inner dia./outer dia. of air supply hose [mm]	Net weight [kg]	Item no.	Designation	Price/unit EUR
100,000	100	0.32	0.32	2.7 / 4	0.296	80115012	PGTS 1/1000 RS	-



PGAS 2/800 RS

Robot spindle manufactured according to the most stringent quality criteria and the latest technological standards with clockwise rotation and exhaust directed to the rear. Suitable for stationary applications in robot cells and machine tools and for installation in transfer lines.

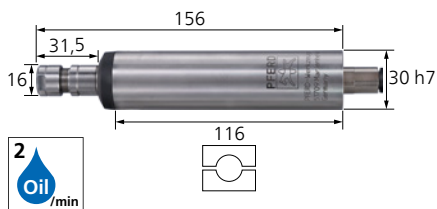
Contents:

Quick coupling (BK 6 mm - 1/4"), 3 mm collet (collet group 23), 2 keys (1x EM SW 9 mm, 1x EM SW 10 mm).

Special features:

- High rotational speeds in a compact design.
- Very high concentricity in continuous use.
- Double spindle bearing for a longer tool life.

RPM	Power output [watts]	Air consumption at idle [m³/min]	Air consumption under load [m³/min]	Inner dia./outer dia. of air supply hose [mm]	Net weight [kg]	Item no.	Designation	Price/unit EUR
80,000	110	0.2	0.18	4 / 6	0.110	80115010	PGAS 2/800 RS	-



PGAS 3/370 RS | PGAS 3/370 RS LL

Robot spindle manufactured according to the most stringent quality criteria and the latest technological standards with clockwise rotation (LL: anti-clockwise) and exhaust directed to the rear. For stationary applications in robot cells and machine tools, and for installation in transfer lines.

Contents:

Quick coupling (BK 8 mm - 1/4"), 6 mm collet (collet group 21), 2 keys (EM SW 14 mm).

Special features:

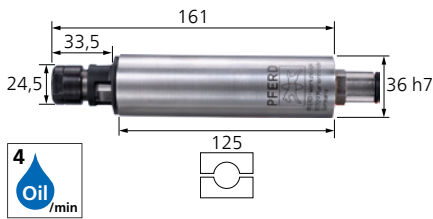
- Stainless steel collet mounting.
- Very high concentricity in continuous use.
- Double spindle bearing for a longer tool life.

RPM	Power output [watts]	Air consumption at idle [m³/min]	Air consumption under load [m³/min]	Inner dia./outer dia. of air supply hose [mm]	Net weight [kg]	Item no.	Designation	Price/unit EUR
37,000	320	0.7	0.5	6 / 8	0.456	80115011	PGAS 3/370 RS	-
		0.8	0.6	6 / 8	0.456	80115013	PGAS 3/370 RS LL	-



Robot spindles for stationary applications

Straight grinder



PGAS 4/280 RS

Robot spindle manufactured according to the most stringent quality criteria and the latest technological standards with clockwise rotation and exhaust directed to the rear. Suitable for stationary applications in robot cells and machine tools and for installation in transfer lines.



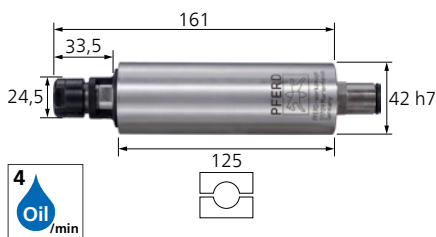
Contents:

Quick coupling (BK 12 mm - 1/4"),
6 mm collet (collet group 16), 2 keys
(1x EM SW 17 mm, 1x DM SW 20/22 mm).

Special features:

- Stainless steel collet mounting.
- Very high concentricity in continuous use.
- Double spindle bearing for a longer tool life.

RPM	Power output [watts]	Air consumption at idle [m ³ /min]	Air consumption under load [m ³ /min]	Inner dia./outer dia. of air supply hose [mm]	Net weight [kg]	Item no.	Designation	Price/unit EUR
28,000	380	0.89	0.69	10 / 12	0.750	80115014	PGAS 4/280 RS	-



PGAS 4/220 RS

Robot spindle manufactured according to the most stringent quality criteria and the latest technological standards with clockwise rotation and exhaust directed to the rear. Suitable for stationary applications in robot cells and machine tools and for installation in transfer lines.

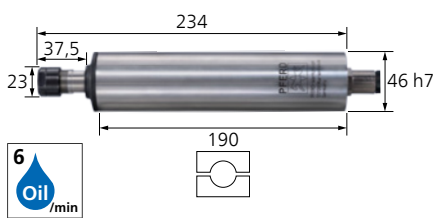
Contents:

Quick coupling (BK 12 mm - 1/4"),
6 mm collet (collet group 16), 2 keys
(1x EM SW 17 mm, 1x DM SW 20/22 mm).

Special features:

- Stainless steel collet mounting.
- Very high concentricity in continuous use.
- Double spindle bearing for a longer tool life.

RPM	Power output [watts]	Air consumption at idle [m ³ /min]	Air consumption under load [m ³ /min]	Inner dia./outer dia. of air supply hose [mm]	Net weight [kg]	Item no.	Designation	Price/unit EUR
22,000	400	0.71	0.51	10 / 12	0.974	80106002	PGAS 4/220 RS	-



PGAS 8/170 RS

Robot spindle manufactured according to the most stringent quality criteria and the latest technological standards with clockwise rotation and exhaust directed to the rear. Suitable for stationary applications in robot cells and machine tools and for installation in transfer lines.

Contents:

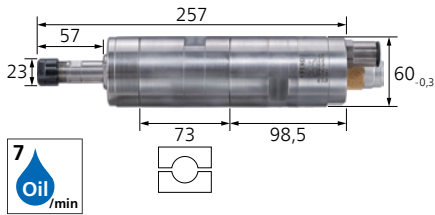
Quick coupling (BK 12 mm - 1/4"),
6 mm collet (collet group 16), 2 keys
(1x EM SW 17 mm, 1x DM SW 20/22 mm).

Special features:

- Stainless steel collet mounting.
- Very high concentricity in continuous use.
- Double spindle bearing for a longer tool life.

RPM	Power output [watts]	Air consumption at idle [m ³ /min]	Air consumption under load [m ³ /min]	Inner dia./outer dia. of air supply hose [mm]	Net weight [kg]	Item no.	Designation	Price/unit EUR
17,000	800	1.15	0.95	10 / 12	1.668	80115015	PGAS 8/170 RS	-





PGAS 11/58 RS

Robot spindle manufactured according to the most stringent quality criteria and the latest technological standards with clockwise rotation and exhaust directed to the rear. Suitable for stationary applications in robot cells and machine tools and for installation in transfer lines.

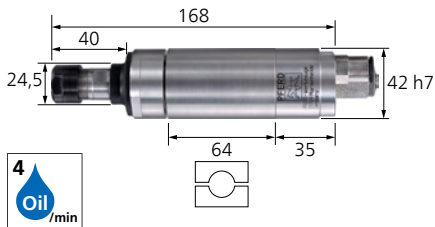
Contents:

Quick coupling (BK 14 mm - 1/2"), speed throttle, 6 mm collet (collet group 16), 2 keys (1x EM SW 17 mm, 1x DM SW 20/22 mm).

Special features:

- High torque due to planetary gear.
- Very high concentricity in continuous use.
- With stainless steel collet mounting and double spindle bearing for a longer tool life.

RPM	Power output [watts]	Air consumption at idle [m ³ /min]	Air consumption under load [m ³ /min]	Inner dia./outer dia. of air supply hose [mm]	Exhaust hose internal dia. [mm]	Net weight [kg]	Item no.	Designation	Price/unit EUR
5,800	1,100	1.58	1.38	11 / 14	16	3.355	80115016	PGAS 11/58 RS	-



PGAS 4/52 RS

Robot spindle manufactured according to the most stringent quality criteria and the latest technological standards with clockwise rotation and exhaust directed to the rear. Suitable for stationary applications in robot cells and machine tools and for installation in transfer lines.

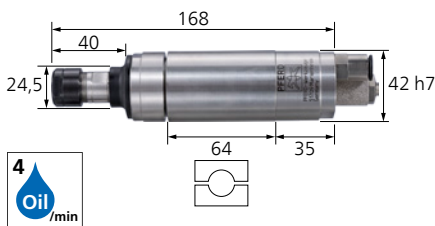
Contents:

Quick coupling (BK 10 mm - 1/4"), speed throttle, 6 mm collet (collet group 16), 2 keys (1x EM SW 17 mm, 1x DM SW 20/22 mm).

Special features:

- High torque due to planetary gear.
- Very high concentricity in continuous use.
- With stainless steel collet mounting and double spindle bearing for a longer tool life.

RPM	Power output [watts]	Air consumption at idle [m ³ /min]	Air consumption under load [m ³ /min]	Inner dia./outer dia. of air supply hose [mm]	Exhaust hose internal dia. [mm]	Net weight [kg]	Item no.	Designation	Price/unit EUR
5,200	380	0.71	0.51	8 / 10	12	1.140	80115017	PGAS 4/52 RS	-



PGAS 4/24 RS

Robot spindle manufactured according to the most stringent quality criteria and the latest technological standards with clockwise rotation and exhaust directed to the rear. Suitable for stationary applications in robot cells and machine tools and for installation in transfer lines.

Contents:

Quick coupling (BK 10 mm - 1/4"), speed throttle, 6 mm collet (collet group 16), 2 keys (1x EM SW 17 mm, 1x DM SW 20/22 mm).

Special features:

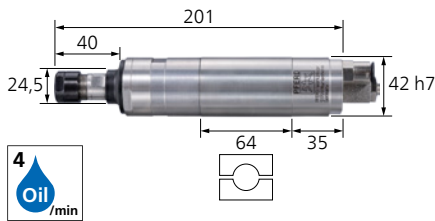
- High torque due to planetary gear.
- Very high concentricity in continuous use.
- With stainless steel collet mounting and double spindle bearing for a longer tool life.

RPM	Power output [watts]	Air consumption at idle [m ³ /min]	Air consumption under load [m ³ /min]	Inner dia./outer dia. of air supply hose [mm]	Exhaust hose internal dia. [mm]	Net weight [kg]	Item no.	Designation	Price/unit EUR
2,400	380	0.71	0.51	8 / 10	12	1.140	80115018	PGAS 4/24 RS	-



Robot spindles for stationary applications

Straight grinder



PGAS 4/12 RS

Robot spindle manufactured according to the most stringent quality criteria and the latest technological standards with clockwise rotation and exhaust directed to the rear. Suitable for stationary applications in robot cells and machine tools and for installation in transfer lines.

Contents:

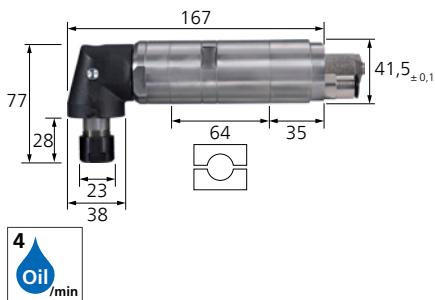
Quick coupling (BK 10 mm - 1/4"), speed throttle, 6 mm collet (collet group 16), 2 keys (1x EM SW 17 mm, 1x DM SW 20/22 mm).

Special features:

- High torque due to planetary gear.
- Very high concentricity in continuous use.
- With stainless steel collet mounting and double spindle bearing for a longer tool life.

RPM	Power output [watts]	Air consumption at idle [m ³ /min]	Air consumption under load [m ³ /min]	Inner dia./outer dia. of air supply hose [mm]	Exhaust hose internal dia. [mm]	Net weight [kg]	Item no.	Designation	Price/unit EUR
1,200	380	0.71	0.51	8 / 10	12	1.415	80115019	PGAS 4/12 RS	-

Angle grinder with collet



PWAS 4/180 RS

Robot spindle manufactured according to the most stringent quality criteria and the latest technological standards with clockwise rotation and exhaust directed to the rear. Suitable for stationary applications in robot cells and machine tools and for installation in transfer lines.

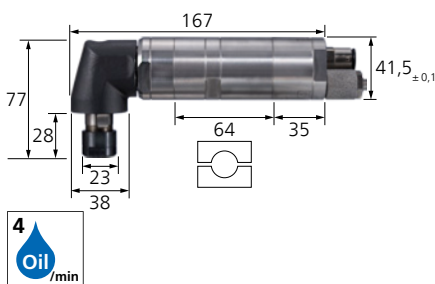
Contents:

Quick coupling (BK 10 mm - 1/4"), speed throttle, 6 mm collet (collet group 16), 2 keys (1x EM SW 17 mm, 1x DM SW 20/22 mm).

Special features:

- Very high concentricity in continuous use.

RPM	Power output [watts]	Air consumption at idle [m ³ /min]	Air consumption under load [m ³ /min]	Inner dia./outer dia. of air supply hose [mm]	Exhaust hose internal dia. [mm]	Net weight [kg]	Item no.	Designation	Price/unit EUR
18,000	380	0.71	0.51	8 / 10	12	1.410	80115021	PWAS 4/180 RS	-



PWAS 4/52 RS

Robot spindle manufactured according to the most stringent quality criteria and the latest technological standards with clockwise rotation and exhaust directed to the rear. Suitable for stationary applications in robot cells and machine tools and for installation in transfer lines.

Contents:

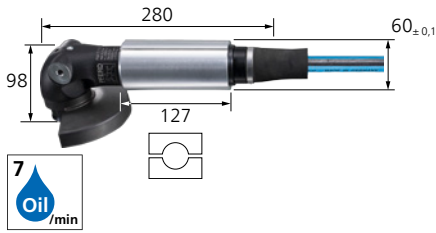
Quick coupling (BK 10 mm - 1/4"), speed throttle, 6 mm collet (collet group 16), 2 keys (1x EM SW 17 mm, 1x DM SW 20/22 mm).

Special features:

- Very high concentricity in continuous use.

RPM	Power output [watts]	Air consumption at idle [m ³ /min]	Air consumption under load [m ³ /min]	Inner dia./outer dia. of air supply hose [mm]	Exhaust hose internal dia. [mm]	Net weight [kg]	Item no.	Designation	Price/unit EUR
5,200	380	0.71	0.51	8 / 10	12	1.410	80115022	PWAS 4/52 RS	-





PWA 11/120 RS

Robot spindle manufactured according to the most stringent quality criteria and the latest technological standards with clockwise rotation and exhaust directed to the rear. Suitable for stationary applications in robot cells and machine tools and for installation in transfer lines.



Contents:

1 m exhaust hose and 2.5 m air supply hose with 1/2" male threaded connection, 1 clamping nut, 2 flange screws, 2 spacer sleeves, 2 keys (1x STL SW 35 x 5 mm, 1x SKS SW 4 mm), guard dia. 125 mm.

Special features:

- With maximum **tool diameter up to 125 mm.**
- Autobalancer on the drive spindle and constant power delivery due to the centrifugal governor.
- Spindle lock pin for tool change with one key.

RPM	Power output [watts]	Air consumption at idle [m ³ /min]	Air consumption under load [m ³ /min]	Spindle thread	Air supply hose internal dia. [mm]	Tool mounting [mm]	Net weight [kg]	Item no.	Designation	Price/unit EUR
12,000	1,100	0.5	1	M14	13	22.23	2.430	80115023	PWA 11/120 RS	-





PGTS 1/1100 DV

Sophisticated air-powered straight grinder with turbine motor, exhaust directed to the front and ring throttle version. Offers maximum cutting speed for TC burrs and mounted points.

Contents:

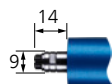
1.5 m air supply hose with 1/4" male threaded connection and threaded quick cou-

pling (STGI), 3 mm collet (collet group 15), 2 keys (DM SW 6/8 mm).

Special features:

- No oil residues on the workpiece.

RPM	Power output [watts]	Air consumption at idle [m ³ /min]	Air consumption under load [m ³ /min]	Air supply hose internal dia. [mm]	Net weight [kg]	Item no.	Designation	Price/unit EUR
110,000	75	0.32	0.15	6	0.188	80107320	PGTS 1/1100 DV	-



PGAS 2/800 E-DV

Sophisticated air-powered straight grinder with elastically mounted spindle and exhaust directed to the rear. Minimizes vibrations when working.

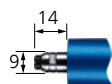
Contents:

0.75 m exhaust hose and 1.5 m air supply hose with 1/4" male threaded connection and threaded quick coupling (STGI), 3 mm collet (collet group 15), 2 keys (DM SW 6/8 mm).

Special features:

- Offers high cutting speed for TC burrs and mounted points.
- The removable spindle sleeve enables narrower and harder-to-reach areas to be accessed more easily.
- Easy guidance thanks to slim, lightweight design.

RPM	Power output [watts]	Air consumption at idle [m ³ /min]	Air consumption under load [m ³ /min]	Air supply hose internal dia. [mm]	Net weight [kg]	Item no.	Designation	Price/unit EUR
80,000	110	0.27	0.26	4.8	0.136	80105021	PGAS 2/800 E-DV	-



PGAS 2/800 E-HV

Sophisticated air-powered straight grinder with elastically mounted spindle, exhaust directed to the rear, ring throttle version and dead man's switch using safety lever valve. Minimizes vibrations when working.

Contents:

0.75 m exhaust hose and 1.5 m air supply hose with 1/4" male threaded connection and threaded quick coupling (STGI), 3 mm collet (collet group 15), 2 keys (DM SW 6/8 mm).

Special features:

- Offers high cutting speed for TC burrs and mounted points.
- The removable spindle sleeve enables narrower and harder-to-reach areas to be accessed more easily.
- Easy guidance thanks to slim, lightweight design.

RPM	Power output [watts]	Air consumption at idle [m ³ /min]	Air consumption under load [m ³ /min]	Air supply hose internal dia. [mm]	Net weight [kg]	Item no.	Designation	Price/unit EUR
80,000	110	0.27	0.26	4.8	0.170	80105022	PGAS 2/800 E-HV	-





PGAS 1/750 DV

Sophisticated air-powered straight grinder with exhaust directed to the rear and ring throttle version. Offers high cutting speed for TC burrs and mounted points.

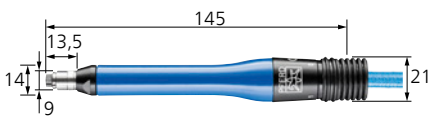
Contents:

0.6 m exhaust hose and 2 m air supply hose with 1/4" male threaded connection and threaded quick coupling (STGI), 3 mm collet (collet group 1), 2 keys (EM SW 7 mm).

Special features:

- Easy guidance thanks to slim, lightweight design.
- The removable spindle sleeve enables narrower and harder-to-reach areas to be accessed more easily.

RPM	Power output [watts]	Air consumption at idle [m ³ /min]	Air consumption under load [m ³ /min]	Air supply hose internal dia. [mm]	Net weight [kg]	Item no.	Designation	Price/unit EUR
75,000	110	0.35	0.2	5	0.142	80700026	PGAS 1/750 DV	-



PGAS 1/700 DV

Sophisticated air-powered straight grinder with exhaust directed to the rear and ring throttle version. Offers high cutting speed for TC burrs and mounted points.



Contents:

0.75 m exhaust hose and 2 m air supply hose with 1/4" male threaded connection and threaded quick coupling (STGI), 3 mm collet (collet group 15), 2 keys (DM SW 6/8 mm).

Special features:

- Light and easy to handle.
- Easy guidance thanks to slim, lightweight design.

RPM	Power output [watts]	Air consumption at idle [m ³ /min]	Air consumption under load [m ³ /min]	Air supply hose internal dia. [mm]	Net weight [kg]	Item no.	Designation	Price/unit EUR
70,000	100	0.25	0.12	4.8	0.090	80105090	PGAS 1/700 DV	-



PGAS 1/700 HV

Sophisticated air-powered straight grinder with exhaust directed to the rear, ring throttle version and dead man's switch using safety lever valve. Offers high cutting speed for TC burrs and mounted points.

Contents:

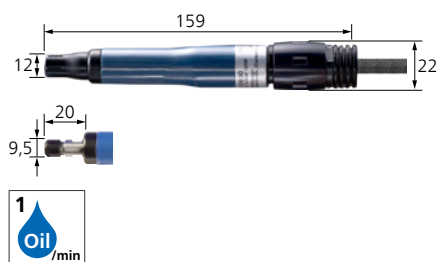
0.75 m exhaust hose and 2 m air supply hose with 1/4" male threaded connection and threaded quick coupling (STGI), 3 mm collet (collet group 15), 2 keys (DM SW 6/8 mm).

Special features:

- Light and easy to handle.
- Easy guidance thanks to slim, lightweight design.

RPM	Power output [watts]	Air consumption at idle [m ³ /min]	Air consumption under load [m ³ /min]	Air supply hose internal dia. [mm]	Net weight [kg]	Item no.	Designation	Price/unit EUR
70,000	100	0.25	0.12	4.8	0.128	80105095	PGAS 1/700 HV	-





PGAS 1/600 DV

Sophisticated air-powered straight grinder with exhaust directed to the rear and ring throttle version. Offers high cutting speed for TC burrs and mounted points.

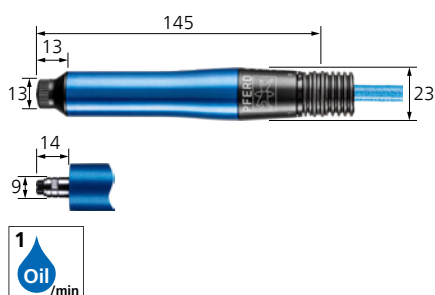
Contents:

0.6 m exhaust hose and 2 m air supply hose with 1/4" male threaded connection and threaded quick coupling (STGI), 3 mm collet (collet group 1), 2 keys (EM SW 7 mm).

Special features:

- Easy guidance thanks to slim, lightweight design.
- The removable spindle sleeve enables narrower and harder-to-reach areas to be accessed more easily.

RPM	Power output [watts]	Air consumption at idle [m ³ /min]	Air consumption under load [m ³ /min]	Air supply hose internal dia. [mm]	Net weight [kg]	Item no.	Designation	Price/unit EUR
60,000	110	0.28	0.2	5	0.142	80700025	PGAS 1/600 DV	-



PGAS 2/600 E-DV

Sophisticated air-powered straight grinder with elastically mounted spindle, exhaust directed to the rear and ring throttle version. High cutting speed for TC burrs and mounted points.

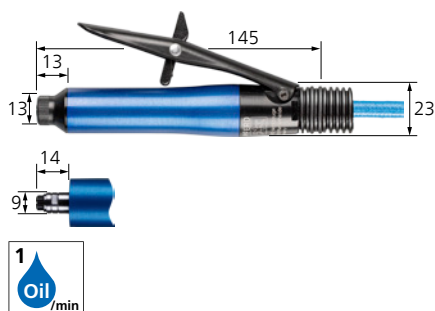
Contents:

0.75 m exhaust hose and 1.5 m air supply hose with 1/4" male threaded connection and threaded quick coupling (STGI), 3 mm collet (collet group 15), 2 keys (DM SW 6/8 mm).

Special features:

- Light and easy to handle and enables low vibrations when working.
- The removable spindle sleeve enables narrower and harder-to-reach areas to be accessed more easily.
- Easy guidance thanks to slim, lightweight design.

RPM	Power output [watts]	Air consumption at idle [m ³ /min]	Air consumption under load [m ³ /min]	Air supply hose internal dia. [mm]	Net weight [kg]	Item no.	Designation	Price/unit EUR
60,000	100	0.26	0.24	4.8	0.137	80105096	PGAS 2/600 E-DV	-



PGAS 2/600 E-HV

Sophisticated air-powered straight grinder with elastically mounted spindle, exhaust directed to the rear, ring throttle version and dead man's switch using safety lever valve. High cutting speed for TC burrs and mounted points.

Contents:

0.75 m exhaust hose and 1.5 m air supply hose with 1/4" male threaded connection and threaded quick coupling (STGI), 3 mm collet (collet group 15), 2 keys (DM SW 6/8 mm).

Special features:

- Light and easy to handle and enables low vibrations when working.
- The removable spindle sleeve enables narrower and harder-to-reach areas to be accessed more easily.
- Easy guidance thanks to slim, lightweight design.

RPM	Power output [watts]	Air consumption at idle [m ³ /min]	Air consumption under load [m ³ /min]	Air supply hose internal dia. [mm]	Net weight [kg]	Item no.	Designation	Price/unit EUR
60,000	100	0.26	0.24	4.8	0.171	80105097	PGAS 2/600 E-HV	-





PGAS 1/550 DV

Sophisticated air-powered straight grinder with exhaust directed to the rear and ring throttle version. Offers high cutting speed for TC burrs and mounted points.



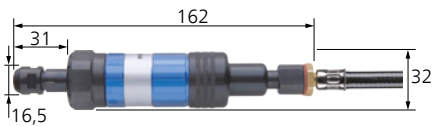
Contents:

0.75 m exhaust hose and 2 m air supply hose with 1/4" male threaded connection and threaded quick coupling (STGI), 3 mm collet (collet group 15), 2 keys (DM SW 6/8 mm).

Special features:

- Easy guidance thanks to slim, lightweight design.

RPM	Power output [watts]	Air consumption at idle [m ³ /min]	Air consumption under load [m ³ /min]	Air supply hose internal dia. [mm]	Net weight [kg]	Item no.	Designation	Price/unit EUR
55,000	100	0.25	0.12	4.8	0.091	80105100	PGAS 1/550 DV	-



PG 3/500 S

Sophisticated air-powered straight grinder with exhaust directed to the front. With push-pull throttle version suitable for continuous use.

Contents:

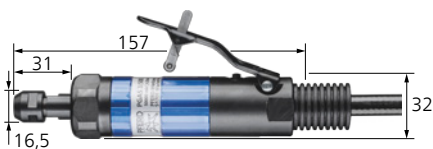
3 m air supply hose with 1/4" male threaded connection and threaded quick coupling

(STGI), 6 mm collet (collet group 5), 2 keys (1x EM SW 7/16", 1x EM SW 9/16").

Special features:

- Light and easy to handle.

RPM	Power output [watts]	Air consumption at idle [m ³ /min]	Air consumption under load [m ³ /min]	Air supply hose internal dia. [mm]	Net weight [kg]	Item no.	Designation	Price/unit EUR
50,000	200	0.45	0.24	8.5	0.370	80107050	PG 3/500 S	-



PGAS 3/500 HV

Sophisticated air-powered straight grinder with exhaust directed to the rear and dead man's switch using safety lever valve.

Contents:

3 m air supply hose with 1/4" male threaded connection and threaded quick coupling (STGI), 1 m exhaust hose, 6 mm collet (collet

group 5), 2 keys (1x EM SW 7/16", 1x EM SW 9/16").

Special features:

- Light and easy to handle.

RPM	Power output [watts]	Air consumption at idle [m ³ /min]	Air consumption under load [m ³ /min]	Air supply hose internal dia. [mm]	Net weight [kg]	Item no.	Designation	Price/unit EUR
50,000	200	0.45	0.24	8.5	0.460	80107055	PGAS 3/500 HV	-





PGAS 3/380 E-DV

Sophisticated air-powered straight grinder with exhaust directed to the rear and ring throttle version.

Contents:

1 m exhaust hose and 2.5 m air supply hose with 1/4" male threaded connection and threaded quick coupling (STGI), 6 mm collet (collet group 6), 2 keys (1x EM SW 11 mm, 1x EM SW 14 mm).

Special features:

- Elastically mounted spindle guarantees a longer tool life, especially when using TC burrs.
- Low vibrations when working.
- The compact design enables good accessibility.

RPM	Power output [watts]	Air consumption at idle [m ³ /min]	Air consumption under load [m ³ /min]	Air supply hose internal dia. [mm]	Net weight [kg]	Item no.	Designation	Price/unit EUR
38,000	290	0.7	0.6	8	0.472	80105153	PGAS 3/380 E-DV	-



PGAS 3/380 E-HV

Sophisticated air-powered straight grinder with exhaust directed to the rear and dead man's switch using safety lever valve.

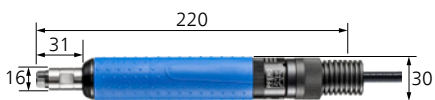
Contents:

1 m exhaust hose and 2.5 m air supply hose with 1/4" male threaded connection and threaded quick coupling (STGI), 6 mm collet (collet group 6), 2 keys (1x EM SW 11 mm, 1x EM SW 14 mm).

Special features:

- Elastically mounted spindle guarantees a longer tool life, especially when using TC burrs.
- Low vibrations when working.
- The compact design enables good accessibility.

RPM	Power output [watts]	Air consumption at idle [m ³ /min]	Air consumption under load [m ³ /min]	Air supply hose internal dia. [mm]	Net weight [kg]	Item no.	Designation	Price/unit EUR
38,000	290	0.7	0.6	8	0.512	80105151	PGAS 3/380 E-HV	-



PGAS 3/350 DV

Sophisticated air-powered straight grinder with exhaust directed to the rear and ring throttle version.

Contents:

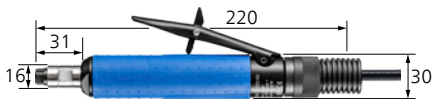
1 m exhaust hose and 2.5 m air supply hose with 1/4" male threaded connection and threaded quick coupling (STGI), 6 mm collet (collet group 6), 2 keys (1x EM SW 11 mm, 1x EM SW 14 mm).

Special features:

- Very easy to handle and guide thanks to the slim, lightweight design.
- High power output with compact design.

RPM	Power output [watts]	Air consumption at idle [m ³ /min]	Air consumption under load [m ³ /min]	Air supply hose internal dia. [mm]	Net weight [kg]	Item no.	Designation	Price/unit EUR
35,000	290	0.6	0.5	6	0.401	80105152	PGAS 3/350 DV	-





PGAS 3/350 HV

Sophisticated air-powered straight grinder with exhaust directed to the rear and dead man's switch using safety lever valve.

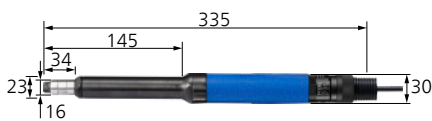
Contents:

1 m exhaust hose and 2.5 m air supply hose with 1/4" male threaded connection and threaded quick coupling (STGI), 6 mm collet (collet group 6), 2 keys (1x EM SW 11 mm, 1x EM SW 14 mm).

Special features:

- Very easy to handle and guide thanks to the slim, lightweight design.
- High power output with compact design.

RPM	Power output [watts]	Air consumption at idle [m ³ /min]	Air consumption under load [m ³ /min]	Air supply hose internal dia. [mm]	Net weight [kg]	Item no.	Designation	Price/unit EUR
35,000	290	0.6	0.5	6	0.441	80105053	PGAS 3/350 HV	-



PGAS 3/350 V-DV

Sophisticated air-powered straight grinder with exhaust directed to the rear and ring throttle version.

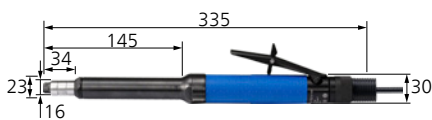
Contents:

1 m exhaust hose and 2.5 m air supply hose with 1/4" male threaded connection and threaded quick coupling (STGI), 6 mm collet (collet group 6), 2 keys (1x EM SW 11 mm, 1x EM SW 14 mm).

Special features:

- Very easy to handle and guide.
- Extended design, ideal for working in hard-to-reach areas.
- High power output with compact design.

RPM	Power output [watts]	Air consumption at idle [m ³ /min]	Air consumption under load [m ³ /min]	Air supply hose internal dia. [mm]	Net weight [kg]	Item no.	Designation	Price/unit EUR
35,000	290	0.6	0.5	6	0.740	80105160	PGAS 3/350 V-DV	-



PGAS 3/350 V-HV

Sophisticated air-powered straight grinder with exhaust directed to the rear and dead man's switch using safety lever valve.

Contents:

1 m exhaust hose and 2.5 m air supply hose with 1/4" male threaded connection and threaded quick coupling (STGI), 6 mm collet (collet group 6), 2 keys (1x EM SW 11 mm, 1x EM SW 14 mm).

Special features:

- Very easy to handle and guide.
- Extended design, ideal for working in hard-to-reach areas.
- High power output with compact design.

RPM	Power output [watts]	Air consumption at idle [m ³ /min]	Air consumption under load [m ³ /min]	Air supply hose internal dia. [mm]	Net weight [kg]	Item no.	Designation	Price/unit EUR
35,000	290	0.6	0.5	6	0.780	80105155	PGAS 3/350 V-HV	-



PGS 3/300 DV

Sophisticated air-powered straight grinder with exhaust directed to the front and ring throttle version.

Contents:

2.5 m air supply hose with 1/4" male threaded connection and threaded quick coupling

(STGI), 6 mm collet (collet group 10), 2 keys (1x EM SW 9 mm, 1x EM SW 10 mm).

Special features:

- Easy to handle and guide.

RPM	Power output [watts]	Air consumption at idle [m ³ /min]	Air consumption under load [m ³ /min]	Air supply hose internal dia. [mm]	Net weight [kg]	Item no.	Designation	Price/unit EUR
30,000	240	0.6	0.5	8	0.348	80106028	PGS 3/300 DV	-



Air grinders

Straight grinder



PGS 3/300 HV

Sophisticated air-powered straight grinder with exhaust directed to the front and dead man's switch using safety lever valve.

Contents:

2.5 m air supply hose with 1/4" male threaded connection and threaded quick coupling

(STGI), 6 mm collet (collet group 10), 2 keys (1x EM SW 9 mm, 1x EM SW 10 mm).

Special features:

- Easy to handle and guide.

RPM	Power output [watts]	Air consumption at idle [m ³ /min]	Air consumption under load [m ³ /min]	Air supply hose internal dia. [mm]	Net weight [kg]	Item no.	Designation	Price/unit EUR
30,000	240	0.6	0.5	8	0.384	80106029	PGS 3/300 HV	-



PGS 3/300 Z-DV

Sophisticated air-powered straight grinder with exhaust directed to the front and ring throttle version.

Contents:

2.5 m air supply hose with 1/4" male threaded connection and threaded quick coupling (STGI), 6 mm collet (collet group 10), 2 keys (1x EM SW 9 mm, 1x EM SW 10 mm).

Special features:

- Precise guidance thanks to extended slim housing.

RPM	Power output [watts]	Air consumption at idle [m ³ /min]	Air consumption under load [m ³ /min]	Air supply hose internal dia. [mm]	Net weight [kg]	Item no.	Designation	Price/unit EUR
30,000	290	0.6	0.5	8	0.433	80106023	PGS 3/300 Z-DV	-



PGS 3/300 Z-HV

Sophisticated air-powered straight grinder with exhaust directed to the front and dead man's switch using safety lever valve.

Contents:

2.5 m air supply hose with 1/4" male threaded connection and threaded quick coupling (STGI), 6 mm collet (collet group 10), 2 keys (1x EM SW 9 mm, 1x EM SW 10 mm).

Special features:

- Precise guidance thanks to extended slim housing.

RPM	Power output [watts]	Air consumption at idle [m ³ /min]	Air consumption under load [m ³ /min]	Air supply hose internal dia. [mm]	Net weight [kg]	Item no.	Designation	Price/unit EUR
30,000	290	0.6	0.5	8	0.469	80106024	PGS 3/300 Z-HV	-



PGAS 4/300 HV

Sophisticated air-powered straight grinder with exhaust directed to the rear and dead man's switch using safety lever valve.

Contents:

1 m exhaust hose and 2.5 m air supply hose with 1/4" male threaded connection and threaded quick coupling (STGI), 6 mm collet

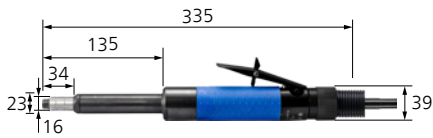
(collet group 20), 2 keys (1x EM SW 12 mm, 1x EM SW 17 mm).

Special features:

- Very powerful with a compact design.

RPM	Power output [watts]	Air consumption at idle [m ³ /min]	Air consumption under load [m ³ /min]	Air supply hose internal dia. [mm]	Net weight [kg]	Item no.	Designation	Price/unit EUR
30,000	440	0.88	0.84	8	0.830	80106021	PGAS 4/300 HV	-





PGAS 4/300 M-HV

Sophisticated air-powered straight grinder with exhaust directed to the rear and dead man's switch using safety lever valve.

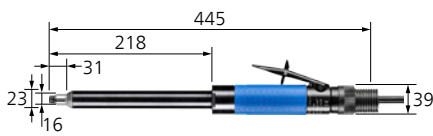
Contents:
1 m exhaust hose and 2.5 m air supply hose with 1/4" male threaded connection and threaded quick coupling (STGI), 6 mm collet

(collet group 6), 2 keys (1x EM SW 11 mm, 1x EM SW 14 mm).

Special features:

- Medium-length design for use when access is restricted.

RPM	Power output [watts]	Air consumption at idle [m ³ /min]	Air consumption under load [m ³ /min]	Air supply hose internal dia. [mm]	Net weight [kg]	Item no.	Designation	Price/unit EUR
30,000	440	0.88	0.84	8	1.198	80106027	PGAS 4/300 M-HV	-



PGAS 4/300 V-HV

Sophisticated air-powered straight grinder with exhaust directed to the rear and dead man's switch using safety lever valve.

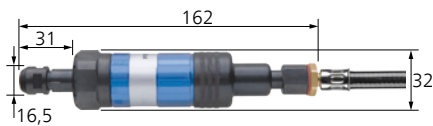
Contents:
1 m exhaust hose and 2.5 m air supply hose with 1/4" male threaded connection and threaded quick coupling (STGI), 6 mm collet

(collet group 6), 2 keys (1x EM SW 11 mm, 1x EM SW 14 mm).

Special features:

- Extended design, ideal for working in hard-to-reach areas.

RPM	Power output [watts]	Air consumption at idle [m ³ /min]	Air consumption under load [m ³ /min]	Air supply hose internal dia. [mm]	Net weight [kg]	Item no.	Designation	Price/unit EUR
30,000	440	0.88	0.84	8	1.421	80106022	PGAS 4/300 V-HV	-



PG 3/250 S

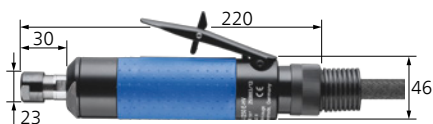
Sophisticated air-powered straight grinder with exhaust directed to the front. Suitable for continuous use thanks to push-pull throttle version. Provides constant power delivery due to the centrifugal governor.

Contents:
3 m air supply hose with 1/4" male threaded connection and threaded quick coupling (STGI), 6 mm collet (collet group 5), 2 keys (1x EM SW 7/16", 1x EM SW 9/16").

Special features:

- Small design.
- Good accessibility thanks to compact design.
- Light and easy to handle.

RPM	Power output [watts]	Air consumption at idle [m ³ /min]	Air consumption under load [m ³ /min]	Air supply hose internal dia. [mm]	Net weight [kg]	Item no.	Designation	Price/unit EUR
25,000	225	0.21	0.49	8.5	0.370	80107060	PG 3/250 S	-



PGAS 4/250 E-HV

Sophisticated air-powered straight grinder with exhaust directed to the rear and dead man's switch using safety lever valve. Can also be operated without oil; however, this will lead to a shorter service life and reduced rotational speed and power output.

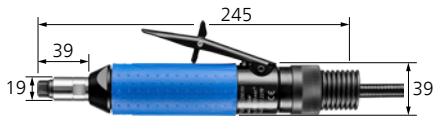
Contents:
1 m exhaust hose and 2.5 m air supply hose with 1/4" male threaded connection and threaded quick coupling (STGI), 6 mm collet (collet group 16), 2 keys (1x EM SW 17 mm, 1x DM SW 20/22 mm).

Special features:

- The elastically mounted spindle enables vibration-low working.
- Particularly suitable for use with TC burrs.

RPM	Power output [watts]	Air consumption at idle [m ³ /min]	Air consumption under load [m ³ /min]	Air supply hose internal dia. [mm]	Net weight [kg]	Item no.	Designation	Price/unit EUR
25,000	440	0.98	0.87	8	0.870	80107181	PGAS 4/250 E-HV	-





PGAS 4/250 HV

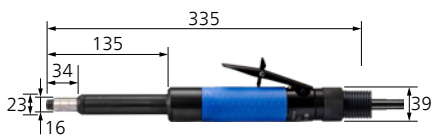
Sophisticated air-powered straight grinder with exhaust directed to the rear and dead man's switch using safety lever valve. Can also be operated without oil; however, this will lead to a shorter service life and reduced rotational speed and power output.

Contents:
1 m exhaust hose and 2.5 m air supply hose with 1/4" male threaded connection and threaded quick coupling (STGI), 6 mm collet

(collet group 20), 2 keys (1x EM SW 12 mm, 1x EM SW 17 mm).

Special features:
■ Very powerful with a compact design.

RPM	Power output [watts]	Air consumption at idle [m ³ /min]	Air consumption under load [m ³ /min]	Air supply hose internal dia. [mm]	Net weight [kg]	Item no.	Designation	Price/unit EUR
25,000	440	0.98	0.87	8	0.830	80106026	PGAS 4/250 HV	-



PGAS 4/250 M-HV

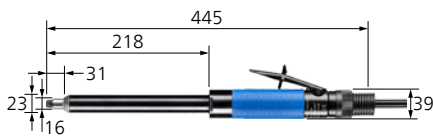
Sophisticated air-powered straight grinder with exhaust directed to the rear and dead man's switch using safety lever valve. Can also be operated without oil; however, this will lead to a shorter service life and reduced rotational speed and power output.

Contents:
1 m exhaust hose and 2.5 m air supply hose with 1/4" male threaded connection and threaded quick coupling (STGI), 6 mm collet

(collet group 6), 2 keys (1x EM SW 11 mm, 1x EM SW 14 mm).

Special features:
■ Medium-length design for use when access is restricted.

RPM	Power output [watts]	Air consumption at idle [m ³ /min]	Air consumption under load [m ³ /min]	Air supply hose internal dia. [mm]	Net weight [kg]	Item no.	Designation	Price/unit EUR
25,000	440	0.98	0.87	8	1.198	80106007	PGAS 4/250 M-HV	-



PGAS 4/250 V-HV

Sophisticated air-powered straight grinder with exhaust directed to the rear and dead man's switch using safety lever valve. Can also be operated without oil; however, this will lead to a shorter service life and reduced rotational speed and power output.

Contents:
1 m exhaust hose and 2.5 m air supply hose with 1/4" male threaded connection and threaded quick coupling (STGI), 6 mm collet

(collet group 6), 2 keys (1x EM SW 11 mm, 1x EM SW 14 mm).

Special features:
■ Extended design, ideal for working in hard-to-reach areas.

RPM	Power output [watts]	Air consumption at idle [m ³ /min]	Air consumption under load [m ³ /min]	Air supply hose internal dia. [mm]	Net weight [kg]	Item no.	Designation	Price/unit EUR
25,000	440	0.98	0.87	8	1.421	80106006	PGAS 4/250 V-HV	-



PGS 6/250 HV

Sophisticated air-powered straight grinder with exhaust directed to the front and dead man's switch using safety lever valve.

Contents:
2 m air supply hose with 1/4" male threaded connection and threaded quick coupling

(STGI), 6 mm collet (collet group 10), 2 keys (1x EM SW 9/16", 1x EM SW 3/4").

Special features:
■ Easy to handle and guide.

RPM	Power output [watts]	Air consumption at idle [m ³ /min]	Air consumption under load [m ³ /min]	Air supply hose internal dia. [mm]	Net weight [kg]	Item no.	Designation	Price/unit EUR
25,000	650	0.95	0.71	8	0.750	80107082	PGS 6/250 HV	-



PGAS 6/250 HV

Sophisticated air-powered straight grinder with exhaust directed to the rear and dead man's switch using safety lever valve. Operate the drive with oil to achieve a high rotational speed and long service life.

Contents:

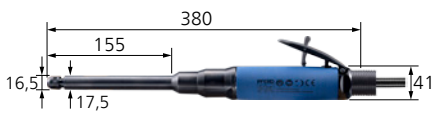
1 m exhaust hose and 2 m air supply hose with 1/4" male threaded connection and threaded quick coupling (STGI), 6 mm collet

(collet group 20), 2 keys (1x EM SW 9/16", 1x EM SW 3/4").

Special features:

- Very powerful with a compact design.

RPM	Power output [watts]	Air consumption at idle [m ³ /min]	Air consumption under load [m ³ /min]	Air supply hose internal dia. [mm]	Net weight [kg]	Item no.	Designation	Price/unit EUR
25,000	650	0.95	0.71	8	0.750	80107086	PGAS 6/250 HV	-



PGAS 6/250 V-HV

Sophisticated air-powered straight grinder with exhaust directed to the rear and dead man's switch using safety lever valve.

Contents:

1 m exhaust hose and 2 m air supply hose with 1/2" male threaded connection, 6 mm collet (collet group 16), 2 keys (1x EM SW 7/16", 1x EM SW 9/16").

Special features:

- Very long design, particularly well suited to working in hard-to-reach areas.

RPM	Power output [watts]	Air consumption at idle [m ³ /min]	Air consumption under load [m ³ /min]	Air supply hose internal dia. [mm]	Net weight [kg]	Item no.	Designation	Price/unit EUR
25,000	650	0.95	0.71	8	1.091	80706081	PGAS 6/250 V-HV	-



PGAS 6/250 VB-HV

Sophisticated air-powered straight grinder with exhaust directed to the rear and dead man's switch using safety lever valve.

Contents:

2 m air supply hose with 1/4" male threaded connection and threaded quick coupling (STGI), 1 m exhaust hose, 6 mm collet (collet group 7), 2 keys (1x EM SW 9/16", 1x EM SW 3/4").

Special features:

- Constant power delivery due to the centrifugal governor.
- Compact design.
- Thanks to its design with wide extension, the drive is ideal for working in hard-to-reach areas.

RPM	Power output [watts]	Air consumption at idle [m ³ /min]	Air consumption under load [m ³ /min]	Air supply hose internal dia. [mm]	Net weight [kg]	Item no.	Designation	Price/unit EUR
25,000	650	0.95	0.71	8	1.316	80700014	PGAS 6/250 VB-HV	-



PGS 4/220 Z-HV

Sophisticated air-powered straight grinder with exhaust directed to the front and dead man's switch using safety lever valve.

Contents:

2.5 m air supply hose with 1/4" male threaded connection and threaded quick coupling (STGI), 6 mm collet (collet group 20), 2 keys (1x EM SW 12 mm, 1x EM SW 17 mm).

Special features:

- Can be guided precisely thanks to comfortable two-handed operation.

RPM	Power output [watts]	Air consumption at idle [m ³ /min]	Air consumption under load [m ³ /min]	Air supply hose internal dia. [mm]	Net weight [kg]	Item no.	Designation	Price/unit EUR
22,000	400	0.98	0.87	8	1.170	80700502	PGS 4/220 Z-HV	-





PGAS 4/220 Z-HV

Sophisticated air-powered straight grinder with exhaust directed to the rear and dead man's switch using safety lever valve. Can also be operated without oil; however, this will lead to a shorter service life and reduced rotational speed and power output.

Contents:

1 m exhaust hose and 2.5 m air supply hose with 1/4" male threaded connection and threaded quick coupling (STGI), 6 mm collet (collet group 20), 2 keys (1x EM SW 12 mm, 1x EM SW 17 mm).

Special features:

- Very powerful with a compact design.
- Can be guided precisely thanks to comfortable two-handed operation.

RPM	Power output [watts]	Air consumption at idle [m ³ /min]	Air consumption under load [m ³ /min]	Air supply hose internal dia. [mm]	Net weight [kg]	Item no.	Designation	Price/unit EUR
22,000	400	0.98	0.87	8	1.221	80106005	PGAS 4/220 Z-HV	-



PG 8/220 HV

Sophisticated air-powered straight grinder with exhaust directed to the front and dead man's switch using safety lever valve.

Contents:

3 m air supply hose with 1/4" male threaded connection and threaded quick coupling

(STGI), 6 mm collet (collet group 7), 2 keys (1x EM SW 9/16", 1x EM SW 3/4").

Special features:

- Compact design.

RPM	Power output [watts]	Air consumption at idle [m ³ /min]	Air consumption under load [m ³ /min]	Air supply hose internal dia. [mm]	Net weight [kg]	Item no.	Designation	Price/unit EUR
22,000	600	0.95	0.85	8.5	0.950	80107081	PG 8/220 HV	-



PGAS 8/220 HV

Sophisticated air-powered straight grinder with exhaust directed to the rear and dead man's switch using safety lever valve.

Contents:

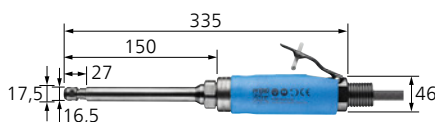
3 m air supply hose with 1/4" male threaded connection and threaded quick coupling (STGI), 1 m exhaust hose, 6 mm collet (collet

group 7), 2 keys (1x EM SW 9/16", 1x EM SW 3/4").

Special features:

- Compact design.

RPM	Power output [watts]	Air consumption at idle [m ³ /min]	Air consumption under load [m ³ /min]	Air supply hose internal dia. [mm]	Net weight [kg]	Item no.	Designation	Price/unit EUR
22,000	600	0.95	0.85	8.5	1.000	80107085	PGAS 8/220 HV	-



PGAS 8/220 VS-HV

Sophisticated air-powered straight grinder with exhaust directed to the rear and dead man's switch using safety lever valve.

Contents:

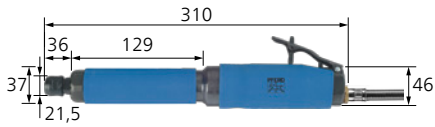
1 m exhaust hose and 3 m air supply hose with 1/4" male threaded connection and threaded quick coupling (STGI), 6 mm collet

(collet group 5), 2 keys (1x EM SW 7/16", 1x EM SW 9/16").

Special features:

- With exceptionally slim drive extension.

RPM	Power output [watts]	Air consumption at idle [m ³ /min]	Air consumption under load [m ³ /min]	Air supply hose internal dia. [mm]	Net weight [kg]	Item no.	Designation	Price/unit EUR
22,000	600	0.95	0.85	8.5	1.170	80706060	PGAS 8/220 VS-HV	-

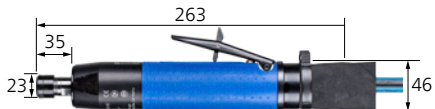


PG 8/220 V-HV

Sophisticated air-powered straight grinder with exhaust directed to the front and dead man's switch using safety lever valve.

Contents: (STGI), 6 mm collet (collet group 7), 2 keys (1x EM SW 9/16", 1x EM SW 3/4").
3 m air supply hose with 1/4" male threaded connection and threaded quick coupling

RPM	Power output [watts]	Air consumption at idle [m³/min]	Air consumption under load [m³/min]	Air supply hose internal dia. [mm]	Net weight [kg]	Item no.	Designation	Price/unit EUR
22,000	600	0.95	0.85	8.5	1.400	80700012	PG 8/220 V-HV	-



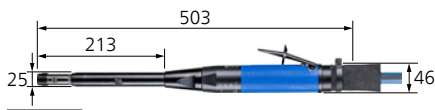
PGAS 10/200 HV

Sophisticated air-powered straight grinder with exhaust directed to the rear and dead man's switch using safety lever valve.

Contents: 1 m exhaust hose and 2.5 m air supply hose with 1/2" male threaded connection, 6 mm collet (collet group 16), 2 keys (1x EM SW 17 mm, 1x DM SW 20/22 mm).

Special features:
■ Powerful drive for heavy-duty use.

RPM	Power output [watts]	Air consumption at idle [m³/min]	Air consumption under load [m³/min]	Air supply hose internal dia. [mm]	Net weight [kg]	Item no.	Designation	Price/unit EUR
20,000	1,000	1.38	1.1	13	1.234	80101046	PGAS 10/200 HV	-



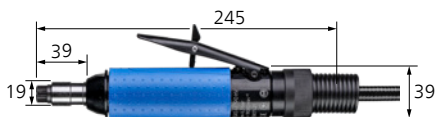
PGAS 10/200 V-HV

Sophisticated air-powered straight grinder with exhaust directed to the rear and dead man's switch using safety lever valve.

Contents: 1 m exhaust hose and 2.5 m air supply hose with 1/2" male threaded connection, 6 mm collet (collet group 16), 2 keys (1x EM SW 17 mm, 1x DM SW 20/22 mm).

Special features:
■ Very long design, particularly well suited to working in hard-to-reach areas.

RPM	Power output [watts]	Air consumption at idle [m³/min]	Air consumption under load [m³/min]	Air supply hose internal dia. [mm]	Net weight [kg]	Item no.	Designation	Price/unit EUR
20,000	1,000	1.38	1.1	13	2.047	80101045	PGAS 10/200 V-HV	-



PGAS 4/190 HV

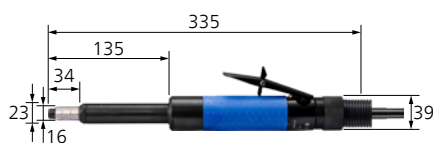
Sophisticated air-powered straight grinder with exhaust directed to the rear and dead man's switch using safety lever valve. Can also be operated without oil; however, this will lead to a shorter service life and reduced rotational speed and power output.

Contents: 1 m exhaust hose and 2.5 m air supply hose with 1/4" male threaded connection and threaded quick coupling (STGI), 6 mm collet (collet group 20), 2 keys (1x EM SW 12 mm, 1x EM SW 17 mm).

Special features:
■ Very powerful with a compact design.

RPM	Power output [watts]	Air consumption at idle [m³/min]	Air consumption under load [m³/min]	Air supply hose internal dia. [mm]	Net weight [kg]	Item no.	Designation	Price/unit EUR
19,000	370	0.78	0.72	8	0.830	80105180	PGAS 4/190 HV	-





PGAS 4/190 M-HV

Sophisticated air-powered straight grinder with exhaust directed to the rear and dead man's switch using safety lever valve. Can also be operated without oil; however, this will lead to a shorter service life and reduced rotational speed and power output.

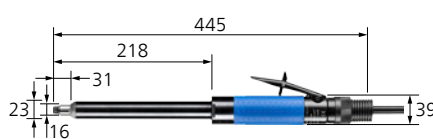
Contents:
1 m exhaust hose and 2.5 m air supply hose with 1/4" male threaded connection and threaded quick coupling (STGI), 6 mm collet

(collet group 6), 2 keys (1x EM SW 11 mm, 1x EM SW 14 mm).

Special features:

- Medium-length design for use when access is restricted.

RPM	Power output [watts]	Air consumption at idle [m ³ /min]	Air consumption under load [m ³ /min]	Air supply hose internal dia. [mm]	Net weight [kg]	Item no.	Designation	Price/unit EUR
19,000	370	0.78	0.72	8	1.198	80105171	PGAS 4/190 M-HV	-



PGAS 4/190 V-HV

Sophisticated air-powered straight grinder with exhaust directed to the rear and dead man's switch using safety lever valve. Can also be operated without oil; however, this will lead to a shorter service life and reduced rotational speed and power output.

Contents:
1 m exhaust hose and 2.5 m air supply hose with 1/4" male threaded connection and threaded quick coupling (STGI), 6 mm collet

(collet group 6), 2 keys (1x EM SW 11 mm, 1x EM SW 14 mm).

Special features:

- Extended design, ideal for working in hard-to-reach areas.

RPM	Power output [watts]	Air consumption at idle [m ³ /min]	Air consumption under load [m ³ /min]	Air supply hose internal dia. [mm]	Net weight [kg]	Item no.	Designation	Price/unit EUR
19,000	370	0.78	0.72	8	1.421	80105170	PGAS 4/190 V-HV	-



PGS 6/160 HV

Sophisticated air-powered straight grinder with exhaust directed to the front and dead man's switch using safety lever valve.

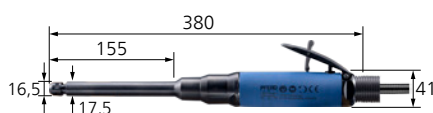
Contents:
2 m air supply hose with 1/4" male threaded connection and threaded quick coupling

(STGI), 6 mm collet (collet group 10), 2 keys (1x EM SW 9/16", 1x EM SW 3/4").

Special features:

- Easy to handle and guide.

RPM	Power output [watts]	Air consumption at idle [m ³ /min]	Air consumption under load [m ³ /min]	Air supply hose internal dia. [mm]	Net weight [kg]	Item no.	Designation	Price/unit EUR
16,000	650	0.39	0.71	8	0.750	80107042	PGS 6/160 HV	-



PGAS 6/160 V-HV

Sophisticated air-powered straight grinder with exhaust directed to the rear and dead man's switch using safety lever valve.

Contents:
1 m exhaust hose and 2 m air supply hose with 1/4" male threaded connection and threaded quick coupling (STGI), 6 mm collet

(collet group 6), 2 keys (1x EM SW 9/16", 1x EM SW 3/4").

Special features:

- Extended design, ideal for working in hard-to-reach areas.

RPM	Power output [watts]	Air consumption at idle [m ³ /min]	Air consumption under load [m ³ /min]	Air supply hose internal dia. [mm]	Net weight [kg]	Item no.	Designation	Price/unit EUR
16,000	650	0.39	0.71	8	1.091	80706071	PGAS 6/160 V-HV	-



PG 8/160 HV

Sophisticated, compact air-powered straight grinder with exhaust directed to the front and dead man's switch using safety lever valve.

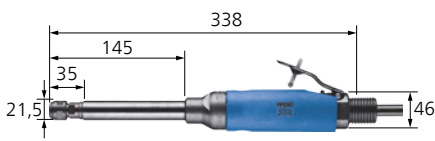
Contents:
3 m air supply hose with 1/4" male threaded connection and threaded quick coupling (STGI), 1 m exhaust hose, 6 mm collet (collet

group 7), 2 keys (1x EM SW 9/16", 1x EM SW 3/4").

Special features:

- Constant power delivery due to the centrifugal governor.

RPM	Power output [watts]	Air consumption at idle [m ³ /min]	Air consumption under load [m ³ /min]	Air supply hose internal dia. [mm]	Net weight [kg]	Item no.	Designation	Price/unit EUR
16,000	600	0.34	0.85	8.5	0.950	80107041	PG 8/160 HV	-



PGAS 8/160 VM-HV

Sophisticated air-powered straight grinder with exhaust directed to the rear, dead man's switch using safety lever valve and slim drive extension.

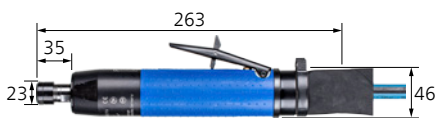
Contents:
3 m air supply hose with 1/4" male threaded connection and threaded quick coupling (STGI), 1 m exhaust hose, 6 mm collet (collet

group 7), 2 keys (1x EM SW 9/16", 1x EM SW 3/4").

Special features:

- Constant power delivery due to the centrifugal governor.

RPM	Power output [watts]	Air consumption at idle [m ³ /min]	Air consumption under load [m ³ /min]	Air supply hose internal dia. [mm]	Net weight [kg]	Item no.	Designation	Price/unit EUR
16,000	600	0.34	0.85	8.5	1.200	80706075	PGAS 8/160 VM-HV	-



PGAS 10/160 HV

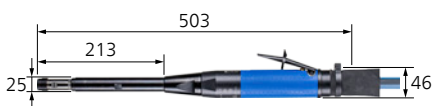
Sophisticated air-powered straight grinder with exhaust directed to the rear and dead man's switch using safety lever valve.

Contents:
1 m exhaust hose and 2.5 m air supply hose with 1/2" male threaded connection, 6 mm collet (collet group 16), 2 keys (1x EM SW 17 mm, 1x DM SW 20/22 mm).

Special features:

- Constant power delivery due to the centrifugal governor.
- Powerful drive for heavy-duty use.

RPM	Power output [watts]	Air consumption at idle [m ³ /min]	Air consumption under load [m ³ /min]	Air supply hose internal dia. [mm]	Net weight [kg]	Item no.	Designation	Price/unit EUR
16,000	1,000	0.7	0.9	13	1.234	80101051	PGAS 10/160 HV	-



PGAS 10/160 V-HV

Sophisticated air-powered straight grinder with exhaust directed to the rear and dead man's switch using safety lever valve.

Contents:
1 m exhaust hose and 2.5 m air supply hose with 1/2" male threaded connection, 6 mm collet (collet group 16), 2 keys (1x EM SW 17 mm, 1x DM SW 20/22 mm).

Special features:

- Very long design, particularly well suited to working in hard-to-reach areas.
- Constant power delivery due to the centrifugal governor.

RPM	Power output [watts]	Air consumption at idle [m ³ /min]	Air consumption under load [m ³ /min]	Air supply hose internal dia. [mm]	Net weight [kg]	Item no.	Designation	Price/unit EUR
16,000	1,000	0.7	0.9	13	2.047	80101050	PGAS 10/160 V-HV	-





PGAS 4/120 E-HV

Sophisticated air-powered straight grinder with exhaust directed to the rear and dead man's switch using safety lever valve. Can also be operated without oil; however, this will lead to a shorter service life and reduced rotational speed and power output.

Contents:

1 m exhaust hose and 2.5 m air supply hose with 1/4" male threaded connection and threaded quick coupling (STGI), 6 mm collet (collet group 16), 2 keys (1x EM SW 17 mm, 1x DM SW 20/22 mm).

Special features:

- The elastically mounted spindle enables vibration-low working.
- Constant power delivery due to the centrifugal governor.

RPM	Power output [watts]	Air consumption at idle [m ³ /min]	Air consumption under load [m ³ /min]	Air supply hose internal dia. [mm]	Net weight [kg]	Item no.	Designation	Price/unit EUR
12,000	440	0.7	0.98	8	1.035	80107191	PGAS 4/120 E-HV	-



PGS 6/120 HV

Sophisticated air-powered straight grinder with exhaust directed to the front and dead man's switch using safety lever valve.



Contents:

2 m air supply hose with 1/4" male threaded connection and threaded quick coupling (STGI), 6 mm collet (collet group 10), 2 keys (1x EM SW 9/16", 1x EM SW 3/4").

Special features:

- Easy to handle and guide.

RPM	Power output [watts]	Air consumption at idle [m ³ /min]	Air consumption under load [m ³ /min]	Air supply hose internal dia. [mm]	Net weight [kg]	Item no.	Designation	Price/unit EUR
12,000	650	0.22	0.71	8	0.750	80107012	PGS 6/120 HV	-



PGAS 6/120 HV

Sophisticated air-powered straight grinder with exhaust directed to the rear and dead man's switch using safety lever valve.

Contents:

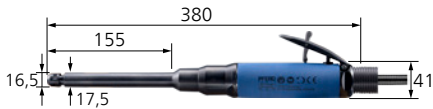
2 m air supply hose with 1/4" male threaded connection and threaded quick coupling (STGI), 1 m exhaust hose, 6 mm collet (collet group 7), 2 keys (1x EM SW 9/16", 1x EM SW 3/4").

Special features:

- Constant power delivery due to the centrifugal governor.
- Compact design.

RPM	Power output [watts]	Air consumption at idle [m ³ /min]	Air consumption under load [m ³ /min]	Air supply hose internal dia. [mm]	Net weight [kg]	Item no.	Designation	Price/unit EUR
12,000	650	0.22	0.71	8	0.750	80107016	PGAS 6/120 HV	-





PGAS 6/120 V-HV

Sophisticated air-powered straight grinder with exhaust directed to the rear and dead man's switch using safety lever valve.

Contents:

1 m exhaust hose and 2 m air supply hose with 1/4" male threaded connection and threaded quick coupling (STGI), 6 mm collet (collet group 6), 2 keys (1x EM SW 9/16", 1x EM SW 3/4").

Special features:

- The tool with wide extension is suitable for working on hard-to-reach areas.
- Its integrated centrifugal governor enables a constant rotational speed to be maintained during use.

RPM	Power output [watts]	Air consumption at idle [m ³ /min]	Air consumption under load [m ³ /min]	Air supply hose internal dia. [mm]	Net weight [kg]	Item no.	Designation	Price/unit EUR
12,000	650	0.22	0.71	8	1.091	80706061	PGAS 6/120 V-HV	-



PGAS 6/120 VB-HV

Sophisticated air-powered straight grinder with exhaust directed to the rear and dead man's switch using safety lever valve.

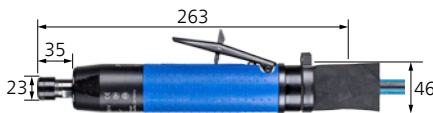
Contents:

2 m air supply hose with 1/4" male threaded connection and threaded quick coupling (STGI), 1 m exhaust hose, 6 mm collet (collet group 7), 2 keys (1x EM SW 9/16", 1x EM SW 3/4").

Special features:

- Constant power delivery due to the centrifugal governor.
- Compact design.
- Thanks to its design with wide extension, the drive is ideal for working in hard-to-reach areas.

RPM	Power output [watts]	Air consumption at idle [m ³ /min]	Air consumption under load [m ³ /min]	Air supply hose internal dia. [mm]	Net weight [kg]	Item no.	Designation	Price/unit EUR
12,000	650	0.22	0.71	8	1.316	80107021	PGAS 6/120 VB-HV	-



PGAS 10/120 HV

Sophisticated air-powered straight grinder with exhaust directed to the rear and dead man's switch using safety lever valve.

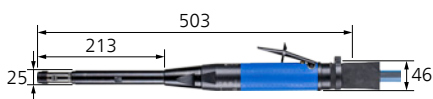
Contents:

1 m exhaust hose and 2.5 m air supply hose with 1/2" male threaded connection, 6 mm collet (collet group 16), 2 keys (1x EM SW 17 mm, 1x DM SW 20/22 mm).

Special features:

- Constant power delivery due to the centrifugal governor.

RPM	Power output [watts]	Air consumption at idle [m ³ /min]	Air consumption under load [m ³ /min]	Air supply hose internal dia. [mm]	Net weight [kg]	Item no.	Designation	Price/unit EUR
12,000	950	0.5	0.9	13	1.234	80101061	PGAS 10/120 HV	-



PGAS 10/120 V-HV

Sophisticated air-powered straight grinder with exhaust directed to the rear and dead man's switch using safety lever valve.

Contents:

1 m exhaust hose and 2.5 m air supply hose with 1/2" male threaded connection, 6 mm collet (collet group 16), 2 keys (1x EM SW 17 mm, 1x DM SW 20/22 mm).

Special features:

- Very long design, particularly well suited to working in hard-to-reach areas.
- Constant power delivery due to the centrifugal governor.

RPM	Power output [watts]	Air consumption at idle [m ³ /min]	Air consumption under load [m ³ /min]	Air supply hose internal dia. [mm]	Net weight [kg]	Item no.	Designation	Price/unit EUR
12,000	950	0.5	0.9	13	2.047	80101060	PGAS 10/120 V-HV	-



Air grinders

Straight grinder



PG 8/100 HV

Sophisticated air-powered straight grinder with exhaust directed to the front and dead man's switch using safety lever valve.



Contents:

3 m air supply hose with 1/4" male threaded connection and threaded quick coupling (STGI), 6 mm collet (collet group 7), 2 keys (1x EM SW 9/16", 1x EM SW 3/4").

Special features:

- Constant power delivery due to the centrifugal governor.
- Compact design.

RPM	Power output [watts]	Air consumption at idle [m ³ /min]	Air consumption under load [m ³ /min]	Air supply hose internal dia. [mm]	Net weight [kg]	Item no.	Designation	Price/unit EUR
10,000	600	0.17	0.85	8.5	0.950	80107011	PG 8/100 HV	-



PGAS 8/100 HV

Sophisticated air-powered straight grinder with exhaust directed to the rear and dead man's switch using safety lever valve.

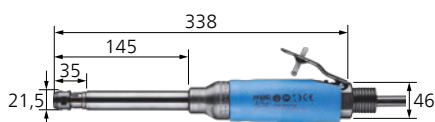
Contents:

3 m air supply hose with 1/4" male threaded connection and threaded quick coupling (STGI), 1 m exhaust hose, 6 mm collet (collet group 7), 2 keys (1x EM SW 9/16", 1x EM SW 3/4").

Special features:

- Constant power delivery due to the centrifugal governor.
- Compact design.

RPM	Power output [watts]	Air consumption at idle [m ³ /min]	Air consumption under load [m ³ /min]	Air supply hose internal dia. [mm]	Net weight [kg]	Item no.	Designation	Price/unit EUR
10,000	600	0.17	0.85	8.5	1.000	80107015	PGAS 8/100 HV	-



PGAS 8/100 VM-HV

Sophisticated air-powered straight grinder with exhaust directed to the rear, dead man's switch using safety lever valve and slim drive extension. Good size/weight to output ratio.

Contents:

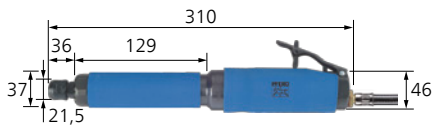
3 m air supply hose with 1/4" male threaded connection and threaded quick coupling (STGI), 1 m exhaust hose, 6 mm collet (collet group 7), 2 keys (1x EM SW 9/16", 1x EM SW 3/4").

Special features:

- Extended version for work in hard-to-reach areas.
- Constant power delivery due to the centrifugal governor.

RPM	Power output [watts]	Air consumption at idle [m ³ /min]	Air consumption under load [m ³ /min]	Air supply hose internal dia. [mm]	Net weight [kg]	Item no.	Designation	Price/unit EUR
10,000	600	0.17	0.85	8.5	1.200	80706085	PGAS 8/100 VM-HV	-





PG 8/100 V-HV

Sophisticated air-powered straight grinder with exhaust directed to the front and dead man's switch using safety lever valve. Good size/weight to output ratio.

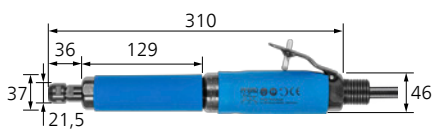
Contents:

3 m air supply hose with 1/4" male threaded connection and threaded quick coupling (STGI), 6 mm collet (collet group 7), 2 keys (1x EM SW 9/16", 1x EM SW 3/4").

Special features:

- Extended version for work in hard-to-reach areas.
- Constant power delivery due to the centrifugal governor.

RPM	Power output [watts]	Air consumption at idle [m ³ /min]	Air consumption under load [m ³ /min]	Air supply hose internal dia. [mm]	Net weight [kg]	Item no.	Designation	Price/unit EUR
10,000	600	0.17	0.85	8.5	1.400	80107003	PG 8/100 V-HV	-



PGAS 8/100 V-HV

Sophisticated air-powered straight grinder with exhaust directed to the rear and dead man's switch using safety lever valve. Good size/weight to output ratio.

Contents:

3 m air supply hose with 1/4" male threaded connection and threaded quick coupling (STGI), 1 m exhaust hose, 6 mm collet (collet group 7), 2 keys (1x EM SW 9/16", 1x EM SW 3/4").

Special features:

- Extended version for work in hard-to-reach areas.
- Constant power delivery due to the centrifugal governor.

RPM	Power output [watts]	Air consumption at idle [m ³ /min]	Air consumption under load [m ³ /min]	Air supply hose internal dia. [mm]	Net weight [kg]	Item no.	Designation	Price/unit EUR
10,000	600	0.17	0.85	8.5	1.400	80107020	PGAS 8/100 V-HV	-



PGAS 3/70 HV

Sophisticated air-powered straight grinder with exhaust directed to the rear and dead man's switch using safety lever valve.

Contents:

1 m exhaust hose and 2.5 m air supply hose with 1/4" male threaded connection and threaded quick coupling (STGI), 6 mm collet

(collet group 6), 2 keys (1x EM SW 11 mm, 1x EM SW 14 mm).

Special features:

- High torque due to planetary gear.
- Compact, easy-to-handle grinder.

RPM	Power output [watts]	Air consumption at idle [m ³ /min]	Air consumption under load [m ³ /min]	Air supply hose internal dia. [mm]	Net weight [kg]	Item no.	Designation	Price/unit EUR
7,000	320	0.6	0.5	8	0.850	80106050	PGAS 3/70 HV	-



Air grinders

Straight grinder



PGAS 6/50 VB-HV

Sophisticated air-powered straight grinder with exhaust directed to the rear and dead man's switch using safety lever valve. The air grinder with fixed rotational speed has to be used with oil.



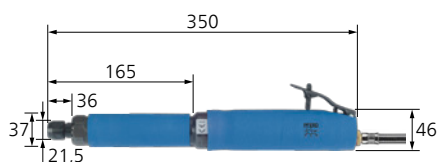
Contents:

1 m exhaust hose and 2 m air supply hose with 1/4" male threaded connection and threaded quick coupling (STGI), 6 mm collet (collet group 6), 2 keys (1x EM SW 9/16", 1x EM SW 3/4").

Special features:

- Thanks to its design with wide extension, the drive is ideal for working in hard-to-reach areas.

RPM	Power output [watts]	Air consumption at idle [m ³ /min]	Air consumption under load [m ³ /min]	Air supply hose internal dia. [mm]	Net weight [kg]	Item no.	Designation	Price/unit EUR
5,000	650	0.95	0.71	8	2.000	80106076	PGAS 6/50 V-HV	-



PG 8/50 V-HV

Sophisticated air-powered straight grinder with exhaust directed to the front and dead man's switch using safety lever valve. The extended version is for work in hard-to-reach areas.

Contents:

3 m air supply hose with 1/4" male threaded connection and threaded quick coupling (STGI), 6 mm collet (collet group 7), 2 keys (1x EM SW 9/16", 1x EM SW 3/4").

Special features:

- Particularly high torque due to reduction gear.
- Can be guided precisely thanks to comfortable two-handed operation.
- Robust design for heavy-duty use.

RPM	Power output [watts]	Air consumption at idle [m ³ /min]	Air consumption under load [m ³ /min]	Air supply hose internal dia. [mm]	Net weight [kg]	Item no.	Designation	Price/unit EUR
5,000	600	0.85	0.34	8.5	1.600	80106075	PG 8/50 V-HV	-



PGAS 3/35 HV

Sophisticated air-powered straight grinder with exhaust directed to the rear and dead man's switch using safety lever valve.

Contents:

1 m exhaust hose and 2.5 m air supply hose with 1/4" male threaded connection and threaded quick coupling (STGI), 6 mm collet

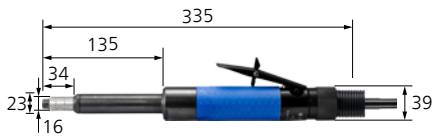
(collet group 6), 2 keys (1x EM SW 11 mm, 1x EM SW 14 mm).

Special features:

- High torque due to planetary gear.
- Compact, easy-to-handle grinder.

RPM	Power output [watts]	Air consumption at idle [m ³ /min]	Air consumption under load [m ³ /min]	Air supply hose internal dia. [mm]	Net weight [kg]	Item no.	Designation	Price/unit EUR
3,500	320	0.6	0.5	8	0.850	80106055	PGAS 3/35 HV	-





PGAS 3/35 M-HV

Sophisticated air-powered straight grinder with exhaust directed to the rear and dead man's switch using safety lever valve.

Contents:

1 m exhaust hose and 2.5 m air supply hose with 1/4" male threaded connection and threaded quick coupling (STGI), 6 mm collet (collet group 6), 2 keys (1x EM SW 11 mm, 1x EM SW 14 mm).

Special features:

- High torque due to planetary gear.
- Thanks to its medium-length design, the drive is ideal for use when access is restricted.

RPM	Power output [watts]	Air consumption at idle [m ³ /min]	Air consumption under load [m ³ /min]	Air supply hose internal dia. [mm]	Net weight [kg]	Item no.	Designation	Price/unit EUR
3,500	320	0.6	0.5	8	1.198	80106065	PGAS 3/35 M-HV	-



PGAS 2/5 DS

Sophisticated air-powered straight grinder with exhaust directed to the rear, instant-start throttle type and easy-to-handle drive for use of countersinks.

Contents:

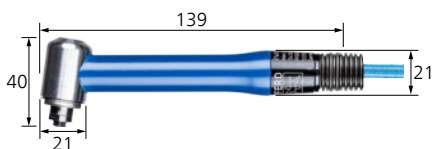
1 m exhaust hose and 2.5 m air supply hose with 1/4" male threaded connection and threaded quick coupling (STGI), 1 overhead trolley, 6 mm collet (collet group 20), 2 keys (1x EM SW 12 mm, 1x EM SW 17 mm).

Special features:

- Instant start enables fast, reliable working.
- Rotational speed regulation for optimum results.

RPM	Power output [watts]	Air consumption at idle [m ³ /min]	Air consumption under load [m ³ /min]	Air supply hose internal dia. [mm]	Net weight [kg]	Item no.	Designation	Price/unit EUR
500	160	0.4	0.3	6	0.564	80106056	PGAS 2/5 DS	-

Angle grinder with collet



PWAS 1/800 DV

Sophisticated air-powered angle grinder with exhaust directed to the rear, collet and ring throttle version. Held like a pen.

Contents:

0.75 m exhaust hose and 1.5 m air supply hose with 1/4" male threaded connection and threaded quick coupling (STGI), 3 mm collet (collet group 2), 2 keys (DM SW 6/8 mm).

Special features:

- Robust, without angular gear.
- Light and easy to handle.
- Smallest, high-revving angle grinder.

RPM	Power output [watts]	Air consumption at idle [m ³ /min]	Air consumption under load [m ³ /min]	Air supply hose internal dia. [mm]	Net weight [kg]	Item no.	Designation	Price/unit EUR
80,000	75	0.15	0.14	4.8	0.094	80205010	PWAS 1/800 DV	-



Air grinders

Angle grinder with collet



PWAS 1/800 HV

Sophisticated air-powered angle grinder with exhaust directed to the rear, collet and dead man's switch using safety lever valve. Held like a pen.

Contents:

0.75 m exhaust hose and 1.5 m air supply hose with 1/4" male threaded connection and threaded quick coupling (STGI), 3 mm collet (collet group 2), 2 keys (DM SW 6/8 mm).

Special features:

- Robust, without angular gear.
- Light and easy to handle.
- Smallest, high-revving angle grinder.

RPM	Power output [watts]	Air consumption at idle [m ³ /min]	Air consumption under load [m ³ /min]	Air supply hose internal dia. [mm]	Net weight [kg]	Item no.	Designation	Price/unit EUR
80,000	75	0.15	0.14	4.8	0.134	80205015	PWAS 1/800 HV	-



PWAS 1/250 DV

Sophisticated compressed-air angle grinder with exhaust directed to the rear and collet. The drive with a ring throttle can be used for continuous use. Compact design and ideal for working in hard-to-reach areas.

Contents:

0.6 m exhaust hose and 2 m air supply hose with 1/4" male threaded connection and threaded quick coupling (STGI), 3 mm collet (collet group 3), 2 keys (1x EM SW 10 mm, 1x EM SW 13/64").

Special features:

- Low angle head height.
- Slim angle head.
- Light and easy to handle.



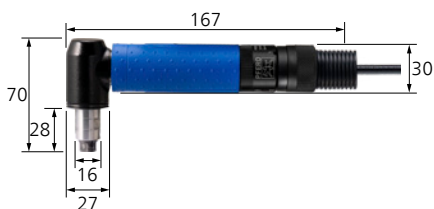
RPM	Power output [watts]	Air consumption at idle [m ³ /min]	Air consumption under load [m ³ /min]	Air supply hose internal dia. [mm]	Net weight [kg]	Item no.	Designation	Price/unit EUR
25,000	110	0.3	0.2	5	0.217	80205025	PWAS 1/250 DV	-



Arbor

The arbor replaces the collet. It is used for direct mounting of COMBIDISC tools.

Net weight [kg]	Item no.	Designation	Price/unit EUR
0.006	80810015	ASD 20 CD 1/4-20 G	-



PWAS 2/200 DV

Sophisticated air-powered angle grinder with exhaust directed to the rear, collet and ring throttle version.

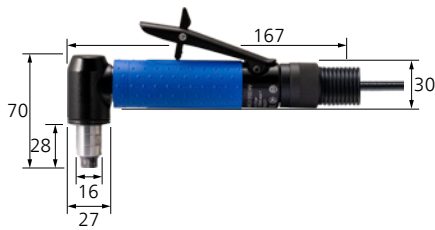
Contents:

1 m exhaust hose and 2.5 m air supply hose with 1/4" male threaded connection and threaded quick coupling (STGI), 6 mm collet (collet group 6), 2 keys (1x EM SW 11 mm, 1x EM SW 14 mm).

Special features:

- Slim angle head for work in hard-to-reach areas.
- Easy to handle, compact shape.

RPM	Power output [watts]	Air consumption at idle [m ³ /min]	Air consumption under load [m ³ /min]	Air supply hose internal dia. [mm]	Net weight [kg]	Item no.	Designation	Price/unit EUR
20,000	230	0.55	0.45	6	0.420	80205038	PWAS 2/200 DV	-



PWAS 2/200 HV

Sophisticated air-powered angle grinder with exhaust directed to the rear, collet and dead man's switch using safety lever valve.

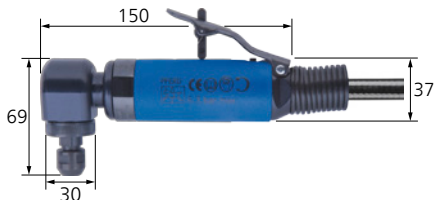
Contents:

1 m exhaust hose and 2.5 m air supply hose with 1/4" male threaded connection and threaded quick coupling (STGI), 6 mm collet (collet group 6), 2 keys (1x EM SW 11 mm, 1x EM SW 14 mm).

Special features:

- Slim angle head for work in hard-to-reach areas.
- Easy to handle, compact shape.

RPM	Power output [watts]	Air consumption at idle [m ³ /min]	Air consumption under load [m ³ /min]	Air supply hose internal dia. [mm]	Net weight [kg]	Item no.	Designation	Price/unit EUR
20,000	230	0.55	0.45	6	0.460	80205036	PWAS 2/200 HV	-



PWSA 4/200 HV

Sophisticated compressed-air angle grinder with exhaust directed to the rear, dead man's switch using safety lever valve and collet. Features a low angle head height and high spindle concentricity.

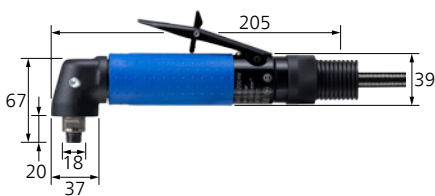
Contents:

1 m exhaust hose and 3 m air supply hose with 1/4" male threaded connection and threaded quick coupling (STGI), 6 mm collet (collet group 5), 2 keys (1x EM SW 7/16", 1x EM SW 9/16").

Special features:

- Compact design.
- Good size/weight to output ratio.
- Dead man's switch using safety lever valve.

RPM	Power output [watts]	Air consumption at idle [m ³ /min]	Air consumption under load [m ³ /min]	Air supply hose internal dia. [mm]	Net weight [kg]	Item no.	Designation	Price/unit EUR
20,000	300	0.57	0.42	8.5	0.520	80700277	PWSA 4/200 HV	-



PWAS 4/200 HV

Sophisticated compressed-air angle grinder with exhaust directed to the rear, dead man's switch using safety lever valve and collet. Ideal for work in hard-to-reach areas.

Contents:

1 m exhaust hose and 2.5 m air supply hose with 1/4" male threaded connection and threaded quick coupling (STGI), 6 mm collet (collet group 6), 2 keys (1x EM SW 11 mm, 1x EM SW 14 mm).

Special features:

- Low angle head height.
- Dead man's switch using safety lever valve.

RPM	Power output [watts]	Air consumption at idle [m ³ /min]	Air consumption under load [m ³ /min]	Air supply hose internal dia. [mm]	Net weight [kg]	Item no.	Designation	Price/unit EUR
20,000	370	0.7	0.6	8	0.920	80209011	PWAS 4/200 HV	-



Air grinders

Angle grinder with collet



PWAS 4/160 HV

Sophisticated compressed-air angle grinder with exhaust directed to the rear, dead man's switch using safety lever valve and collet. Ideal for work in hard-to-reach areas.

Contents:

1 m exhaust hose and 2.5 m air supply hose with 1/4" male threaded connection and threaded quick coupling (STGI), 6 mm collet (collet group 6), 2 keys (1x EM SW 11 mm, 1x EM SW 14 mm).

Special features:

- Low angle head height.
- Constant power delivery due to the centrifugal governor.

RPM	Power output [watts]	Air consumption at idle [m ³ /min]	Air consumption under load [m ³ /min]	Air supply hose internal dia. [mm]	Net weight [kg]	Item no.	Designation	Price/unit EUR
16,000	370	0.55	0.6	8	1.004	80209016	PWAS 4/160 HV	-



PWAS 4/120 HV

Sophisticated compressed-air angle grinder with exhaust directed to the rear, dead man's switch using safety lever valve and collet. Ideal for work in hard-to-reach areas.

Contents:

1 m exhaust hose and 2.5 m air supply hose with 1/4" male threaded connection and threaded quick coupling (STGI), 6 mm collet (collet group 6), 2 keys (1x EM SW 11 mm, 1x EM SW 14 mm).

Special features:

- Low angle head height.
- Constant power delivery due to the centrifugal governor.

RPM	Power output [watts]	Air consumption at idle [m ³ /min]	Air consumption under load [m ³ /min]	Air supply hose internal dia. [mm]	Net weight [kg]	Item no.	Designation	Price/unit EUR
12,000	370	0.5	0.6	8	1.004	80209006	PWAS 4/120 HV	-

Angle grinder with threaded spindle



PWA 2/120 DV

Sophisticated air-powered angle grinder with 1/4-20 UNC threaded spindle, exhaust directed to the rear and ring throttle version.

Contents:

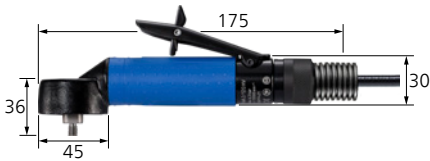
1 m exhaust hose and 2.5 m air supply hose with 1/4" male threaded connection and threaded quick coupling (STGI), 1 key (EM SW 11 mm).

Special features:

- Special spindle for holding all COMBIDISC tools (use a backing pad without shank).
- Flat angle head for work in hard-to-reach areas.

RPM	Power output [watts]	Air consumption at idle [m ³ /min]	Air consumption under load [m ³ /min]	Air supply hose internal dia. [mm]	Net weight [kg]	Item no.	Designation	Price/unit EUR
12,000	230	0.55	0.45	6	0.476	80205039	PWA 2/120 DV	-





PWA 2/120 HV

Sophisticated air-powered angle grinder with 1/4-20 UNC threaded spindle, exhaust directed to the rear and dead man's switch using safety lever valve.

Contents:

1 m exhaust hose and 2.5 m air supply hose with 1/4" male threaded connection and threaded quick coupling (STGI), 1 key (EM SW 11 mm).

Special features:

- Special spindle for holding all COMBIDISC tools (use a backing pad without shank).
- Flat angle head for work in hard-to-reach areas.

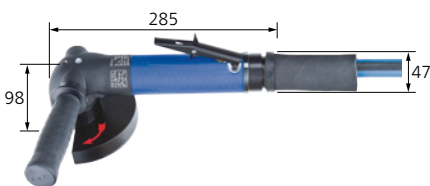
RPM	Power output [watts]	Air consumption at idle [m ³ /min]	Air consumption under load [m ³ /min]	Air supply hose internal dia. [mm]	Net weight [kg]	Item no.	Designation	Price/unit EUR
12,000	230	0.55	0.45	6	0.516	80205037	PWA 2/120 HV	-



Extensions for drive spindles

The shank of the abrasive disc holders can be replaced by suitable adapters. This enables the abrasive disc holder to be mounted directly to the drive spindle of the tool drive. Suitable for drives with spindle 1/4-20 UNC.

Net weight [kg]	Item no.	Designation	Price/unit EUR
0.010	87100727	SPV20 CD 1/4-20 UNC	-



PWA 11/120 HV

Sophisticated compressed-air angle grinder with M14 threaded spindle and 22.23 mm tool mounting, exhaust directed to the rear and dead man's switch using safety lever valve. With maximum **tool diameter up to 125 mm**.

Contents:

1 m exhaust hose and 2.5 m air supply hose with 1/2" male threaded connection, 1 clamping nut (item no. 98980036), 2 flange screws (1x item no. 98980037, 1x item no. 98980038), 2 spacer sleeves (1x item no. 98980039, 1x item no. 98980040), 2 keys (1x item no. 91244601, 1x item

no. 92785502), guard dia. 125 mm, anti-vibration handle.

Special features:

- Robust design for heavy-duty use.
- Constant power delivery due to the centrifugal governor.
- Spindle lock pin for tool change with one key.

RPM	Power output [watts]	Air consumption at idle [m ³ /min]	Air consumption under load [m ³ /min]	Air supply hose internal dia. [mm]	Net weight [kg]	Item no.	Designation	Price/unit EUR
12,000	1,100	0.5	1.2	13	2.100	80204081	PWA 11/120 HV	-



Air grinders

Angle grinder with threaded spindle



PWT 26/120 HV M14

Sophisticated compressed-air angle grinder with M14 threaded spindle and 22.23 mm tool mounting, exhaust directed to the bottom and dead man's switch using safety lever valve. With maximum **tool diameter of up to 125 mm** and very powerful turbine motor.



Contents:

1/2" female connecting thread, 2 keys (1x item no. 91244601, 1x item no. 92785503), 1 clamping nut (item no. 90011450), 1 clamping flange (item no. 90011455), 1 spacer (item no. 90011460), guard dia. 125 mm, anti-vibration handle.

Special features:

- M14 threaded spindle for convenient mounting of various tools.
- Constant power delivery due to the centrifugal governor and with spindle lock pin for tool change with one key.

RPM	Power output [watts]	Air consumption at idle [m ³ /min]	Air consumption under load [m ³ /min]	Air supply hose internal dia. [mm]	Net weight [kg]	Item no.	Designation	Price/unit EUR
12,000	2,600	0.9	2.25	16	2.200	80201010	PWT 26/120 HV M14	-



PWT 26/100 HV M14

Sophisticated compressed-air angle grinder with M14 threaded spindle and 22.23 mm tool mounting, exhaust directed to the bottom and dead man's switch using safety lever valve. With maximum **tool diameter of up to 150 mm** and very powerful turbine motor.

Contents:

1/2" female connecting thread, 2 keys (1x item no. 91244601, 1x item no. 92785503), 2 clamping nuts (1x item no. 90011450, 1x item no. 90011451), 3 clamping flanges (1x item no. 90011456, 1x item no. 90011457, 1x item no. 90011458), guard dia. 150 mm, anti-vibration handle.

Special features:

- M14 threaded spindle for convenient mounting of various tools.
- Constant power delivery due to the centrifugal governor and with spindle lock pin for tool change with one key.

RPM	Power output [watts]	Air consumption at idle [m ³ /min]	Air consumption under load [m ³ /min]	Air supply hose internal dia. [mm]	Net weight [kg]	Item no.	Designation	Price/unit EUR
10,000	2,600	0.9	2.25	16	2.580	80201020	PWT 26/100 HV M14	-





PWT 26/85 HV M14

Sophisticated compressed-air angle grinder with M14 threaded spindle and 22.23 mm tool mounting, exhaust directed to the bottom and dead man's switch using safety lever valve. With maximum **tool diameter of up to 180 mm** and very powerful turbine motor.



Contents:

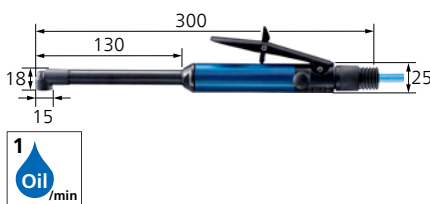
1/2" female connecting thread, 2 keys (1x item no. 91244601, 1x item no. 92785503), 2 clamping nuts (1x item no. 90011450, 1x item no. 90011451), 3 clamping flanges (1x item no. 90011456, 1x item no. 90011457, 1x item no. 90011458), guard dia. 150 mm, anti-vibration handle.

Special features:

- M14 threaded spindle for convenient mounting of various tools.
- Constant power delivery due to the centrifugal governor and with spindle lock pin for tool change with one key.

RPM	Power output [watts]	Air consumption at idle [m ³ /min]	Air consumption under load [m ³ /min]	Air supply hose internal dia. [mm]	Net weight [kg]	Item no.	Designation	Price/unit EUR
8,500	2,600	0.9	2.25	16	2.800	80201030	PWT 26/85 HV M14	-

Angle grinder with hexagon mounting



PWA 1/9 VB-HV HEX 3MM

Sophisticated compressed-air angle grinder with low air consumption and adjustable rotational speed regulation. Ideal for deburring hard-to-reach areas such as holes with cross holes.



Contents:

1 m exhaust hose and 2.5 m air supply hose with 1/4" male threaded connection and threaded quick coupling (STGI).

Special features:

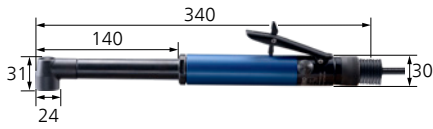
- Very quiet and robust.

RPM	Power output [watts]	Air consumption at idle [m ³ /min]	Air consumption under load [m ³ /min]	Air supply hose internal dia. [mm]	Net weight [kg]	Item no.	Designation	Price/unit EUR
900	35	0.19	0.17	4.8	0.400	80700492	PWA 1/9 V-HV HEX 3 mm	-



Air grinders

Angle grinder with hexagon mounting



PWA 1/5 V-HV HEX 1/4"

Sophisticated compressed-air angle grinder with low air consumption and adjustable rotational speed regulation. Ideal for deburring hard-to-reach areas such as holes with cross holes.



Contents:

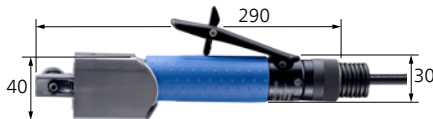
1 m exhaust hose and 2.5 m air supply hose with 1/4" male threaded connection and threaded quick coupling (STGI).

Special features:

- Very quiet and robust.

RPM	Power output [watts]	Air consumption at idle [m ³ /min]	Air consumption under load [m ³ /min]	Air supply hose internal dia. [mm]	Net weight [kg]	Item no.	Designation	Price/unit EUR
500	65	0.35	0.3	6	0.850	80700493	PWA 1/5 V-HV HEX 1/4"	-

Belt grinders and belt arms



PBA 2/200 HV OVA

Sophisticated compressed-air belt grinder with a **belt length of 305 mm x belt width 3 – 16 mm**, exhaust directed to the rear and dead man's switch using safety lever valve.

Contents:

1 m exhaust hose and 2.5 m air supply hose with 1/4" male threaded connection and threaded quick coupling (STGI), 1 key (1x SKS SW 4 mm), protective cover.

Special features:

- Suitable for belt grinder attachment arms from group 1.
- Easy to handle, compact shape.

Belt speed [m/s]	Power output [watts]	Air consumption at idle [m ³ /min]	Air consumption under load [m ³ /min]	Air supply hose internal dia. [mm]	Net weight [kg]	Item no.	Designation	Price/unit EUR
22	230	0.55	0.45	6	0.604	80705052	PBA 2/200 HV OVA	-



PBA 2/200 HV

Sophisticated compressed-air belt grinder with a **belt length of 305 mm x belt width 3 – 16 mm**, exhaust directed to the rear and dead man's switch using safety lever valve.

Contents:

1 m exhaust hose and 2.5 m air supply hose with 1/4" male threaded connection and threaded quick coupling (STGI), 1 key (1x SKS SW 4 mm), protective cover.

Special features:

- Incl. belt grinder attachment arm BSVAK 9/9 x 305 (belt grinder attachment arm group 1).
- Easy to handle, compact shape.

Belt speed [m/s]	Power output [watts]	Air consumption at idle [m ³ /min]	Air consumption under load [m ³ /min]	Air supply hose internal dia. [mm]	Net weight [kg]	Item no.	Designation	Price/unit EUR
22	230	0.55	0.45	6	0.687	80705051	PBA 2/200 HV	-



Adapter for the belt grinder attachment arm group 2

Adapter for belt grinder attachment arm. Enables the use of belts with a belt length of 610 mm and a belt width of 3 – 20 mm.

Suitable belt length [mm]	Net weight [kg]	Item no.	Designation	Price/unit EUR
610	0.080	84200230	BSAD 41/36 x 610	-



Belt grinder attachment arm BSVAK 9/25

Belt grinder attachment arm in robust design and extremely slim fixing lug on the facing roller. With belt arm guide that can be fixed.

Special features:

- With asymmetrical arms for flush lateral grinding.

Width x roll dia. [mm]	Suitable belt width [mm]	Suitable belt length [mm]	Net weight [kg]	Item no.	Designation	Price/unit EUR
9 x 25	3, 6, 9, 12, 16	305	0.083	84200318	BSVAK 9/25 x 305	-



Belt grinder attachment arm BSVAK 9/25-1

Belt grinder attachment arm in robust design and extremely slim fixing lug on the facing roller. With belt arm guide that can be fixed.

Special features:

- With asymmetrical arms for flush lateral grinding.
- With conical guide roller (range 1 mm).

Width x roll dia. [mm]	Suitable belt width [mm]	Suitable belt length [mm]	Net weight [kg]	Item no.	Designation	Price/unit EUR
9 x 25	3, 6, 9, 12	305	0.082	84200319	BSVAK 9/25-1 x 305	-



Belt grinder attachment arm BSVAK 4/16

Belt grinder attachment arm in robust design and extremely slim fixing lug on the facing roller. With belt arm guide that can be fixed.

Special features:

- Use of the full roller width.
- With pad for stabilization/support.

Width x roll dia. [mm]	Suitable belt width [mm]	Suitable belt length [mm]	Net weight [kg]	Item no.	Designation	Price/unit EUR
4 x 16	3, 6, 9	305	0.052	84200315	BSVAK 4/16 x 305	-



Belt grinder attachment arm BSVAK 9/16

Belt grinder attachment arm in robust design and extremely slim fixing lug on the facing roller. With belt arm guide that can be fixed.

Special features:

- Use of the full roller width.
- With pad for stabilization/support.

Width x roll dia. [mm]	Suitable belt width [mm]	Suitable belt length [mm]	Net weight [kg]	Item no.	Designation	Price/unit EUR
9 x 16	9, 12	305	0.088	84200317	BSVAK 9/16 x 305	-



Belt grinder attachment arm BSVAK 9/9

Belt grinder attachment arm in robust design and extremely slim fixing lug on the facing roller. With belt arm guide that can be fixed.

Special features:

- Use of the full roller width.
- With pad for stabilization/support.

Width x roll dia. [mm]	Suitable belt width [mm]	Suitable belt length [mm]	Net weight [kg]	Item no.	Designation	Price/unit EUR
9 x 9	9, 12	305	0.075	84200316	BSVAK 9/9 x 305	-



Air grinders

Belt grinders and belt arms



PBA 4/160 HV OVA

Sophisticated compressed-air belt grinder with a **belt length of 520 mm (*610 mm) x belt width 3 – 20 mm**, exhaust directed to the rear and dead man's switch using safety lever valve.

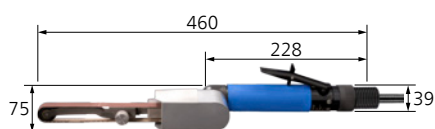
Contents:

1 m exhaust hose and 2.5 m air supply hose with 1/4" male threaded connection and threaded quick coupling (STGI), 2 keys (1x SKS SW 2.5 mm, 1x SKS SW 4 mm), protective cover.

Special features:

- Suitable for belt grinder attachment arms from group 2.
- Easy to handle, compact shape.
- *The BSAD 41/36 x 610 belt grinding adapter achieves a belt length of 610 mm.

Belt speed [m/s]	Power output [watts]	Air consumption at idle [m ³ /min]	Air consumption under load [m ³ /min]	Air supply hose internal dia. [mm]	Net weight [kg]	Item no.	Designation	Price/unit EUR
19.3	370	0.55	0.6	8	1.191	80705012	PBA 4/160 HV OVA	-



PBA 4/160 HV

Sophisticated compressed-air belt grinder with a **belt length of 520 mm (*610 mm) x belt width 3 – 20 mm**, exhaust directed to the rear and dead man's switch using safety lever valve.

Contents:

1 m exhaust hose and 2.5 m air supply hose with 1/4" male threaded connection and threaded quick coupling (STGI), protective cover, 2 keys (1x SKS SW 2.5 mm, 1x SKS SW 4 mm).

Special features:

- *With adapter BSAD 41/36 x 610.
- The belt grinder attachment can be pivoted on the drive system.
- Incl. belt grinder attachment arm BSVA 9/25x520 (belt grinder attachment arm group 2).

Belt speed [m/s]	Power output [watts]	Air consumption at idle [m ³ /min]	Air consumption under load [m ³ /min]	Air supply hose internal dia. [mm]	Net weight [kg]	Item no.	Designation	Price/unit EUR
19.3	370	0.55	0.6	8	1.286	80705011	PBA 4/160 HV	-

Belt grinder attachment arm group 2



Belt grinder attachment arm BSVA 9/25-1

Belt grinder attachment arm in robust design and extremely slim fixing lug on the facing roller. With belt arm guide that can be fixed.

Special features:

- Use of the full roller width.
- With conical guide roller (range 1 mm).

Width x roll dia. [mm]	Suitable belt width [mm]	Suitable belt length [mm]	Net weight [kg]	Item no.	Designation	Price/unit EUR
9 x 25	3, 6, 9, 12	520, 610	0.095	84200072	BSVA 9/25-1 x 520	-



Belt grinder attachment arm BSVA 4/16

Belt grinder attachment arm in robust design and extremely slim fixing lug on the facing roller. With belt arm guide that can be fixed.

Special features:

- Use of the full roller width.

Width x roll dia. [mm]	Suitable belt width [mm]	Suitable belt length [mm]	Net weight [kg]	Item no.	Designation	Price/unit EUR
4 x 16	3, 6, 9	520, 610	0.060	84200050	BSVA 4/16 x 520	-



Belt grinder attachment arm BSVA 9/16

Belt grinder attachment arm in robust design and extremely slim fixing lug on the facing roller. With belt arm guide that can be fixed.

Special features:

- Use of the full roller width.

Width x roll dia. [mm]	Suitable belt width [mm]	Suitable belt length [mm]	Net weight [kg]	Item no.	Designation	Price/unit EUR
9 x 16	9, 12	520, 610	0.096	84200060	BSVA 9/16 x 520	-



Belt grinder attachment arm BSVA 12/19

Belt grinder attachment arm in robust design and extremely slim fixing lug on the facing roller. With belt arm guide that can be fixed.

Special features:

- Use of the full roller width.

Width x roll dia. [mm]	Suitable belt width [mm]	Suitable belt length [mm]	Net weight [kg]	Item no.	Designation	Price/unit EUR
12 x 19	12, 16	520, 610	0.107	84200080	BSVA 12/19 x 520	-



Belt grinder attachment arm BSVA 9/25

Belt grinder attachment arm in robust design and extremely slim fixing lug on the facing roller. With asymmetrical arms for flush lateral grinding and belt arm guide that can be fixed.

Special features:

- Use of the full roller width.

Width x roll dia. [mm]	Suitable belt width [mm]	Suitable belt length [mm]	Net weight [kg]	Item no.	Designation	Price/unit EUR
9 x 25	3, 6, 9, 12, 16	520, 610	0.095	84200070	BSVA 9/25 x 520	-



Belt grinder attachment arm BSVA 18/23

Belt grinder attachment arm in robust design. With belt arm guide that can be fixed.

Special features:

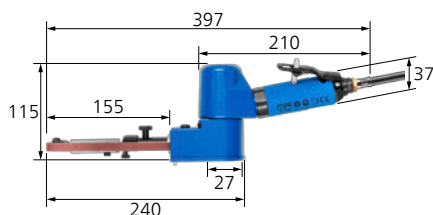
- With metal roller and pad for stabilization/support.

Width x roll dia. [mm]	Suitable belt width [mm]	Suitable belt length [mm]	Net weight [kg]	Item no.	Designation	Price/unit EUR
18 x 23	20	520, 610	0.150	84200085	BSVA 18/23 x 520	-



Air grinders

Belt grinders and belt arms



PBS 5/155 HV 824

Sophisticated compressed-air belt grinder with a **belt length of 480 mm (*610 mm) x belt width 6 – 25 mm**, attachment arm, exhaust directed to the front and dead man's switch using safety lever valve.

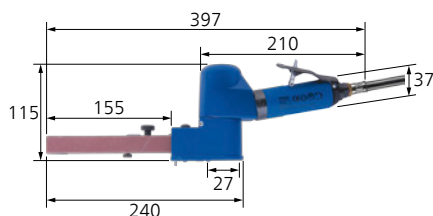
Contents:

3 m air supply hose with 1/4" male threaded connection and threaded quick coupling (STGI), 2 keys (1x SKS SW 3 mm, 1x SKS SW 5/32"), belt grinder attachment arm BSWA 5/155-8/24 x 480.

Special features:

- *Belt length 610 mm x width 6 – 12 mm with belt grinder attachment arm from group 3.
- The belt grinder attachment can be pivoted on the drive system.
- Balanced handling.

Belt speed [m/s]	Power output [watts]	Air consumption at idle [m ³ /min]	Air consumption under load [m ³ /min]	Air supply hose internal dia. [mm]	Net weight [kg]	Item no.	Designation	Price/unit EUR
21	370	0.6	0.4	8.5	1.390	80704010	PBS 5/155 HV 824	-



PBS 5/155 HV 2324

Sophisticated compressed-air belt grinder with a **belt length of 480 mm (*610 mm) x belt width 6 – 25 mm**, attachment arm, exhaust directed to the front and dead man's switch using safety lever valve.

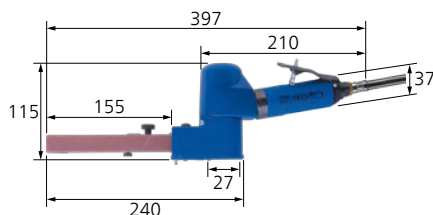
Contents:

3 m air supply hose with 1/4" male threaded connection and threaded quick coupling (STGI), 2 keys (1x SKS SW 3 mm, 1x SKS SW 5/32"), belt grinder attachment arm BSWA 5/155-23/24 x 480.

Special features:

- *Belt length 610 mm x width 6 – 12 mm with belt grinder attachment arm from group 3.
- The belt grinder attachment can be pivoted on the drive system.
- Balanced handling.

Belt speed [m/s]	Power output [watts]	Air consumption at idle [m ³ /min]	Air consumption under load [m ³ /min]	Air supply hose internal dia. [mm]	Net weight [kg]	Item no.	Designation	Price/unit EUR
21	370	0.6	0.4	8.5	1.390	80704025	PBS 5/155 HV 2324	-



PBS 5/155 HV 1924

Sophisticated compressed-air belt grinder with a **belt length of 480 mm (*610 mm) x belt width 6 – 25 mm**, attachment arm, exhaust directed to the front and dead man's switch using safety lever valve.

Contents:

3 m air supply hose with 1/4" male threaded connection and threaded quick coupling (STGI), 2 keys (1x SKS SW 3 mm, 1x SKS SW 5/32"), belt grinder attachment arm BSWA 5/155-19/24 x 480.

Special features:

- *Belt length 610 mm x width 6 – 12 mm with belt grinder attachment arm from group 3.
- The belt grinder attachment can be pivoted on the drive system.
- Balanced handling.

Belt speed [m/s]	Power output [watts]	Air consumption at idle [m ³ /min]	Air consumption under load [m ³ /min]	Air supply hose internal dia. [mm]	Net weight [kg]	Item no.	Designation	Price/unit EUR
21	370	0.6	0.4	8.5	1.390	80704020	PBS 5/155 HV 1924	-





Belt grinder attachment arm BSVA 5/155-19/24x480

Belt grinder attachment arm in robust steel design and with belt arm guide that can be fixed.

Special features:

- Use of the full roller width.

Width x roll dia. [mm]	Suitable belt width [mm]	Suitable belt length [mm]	Net weight [kg]	Item no.	Designation	Price/unit EUR
19 x 24	16, 20	480	0.086	90002115	BSVA 5/155-19/24x480	-



Belt grinder attachment arm BSVA 5/155-8/24x480

Belt grinder attachment arm in robust steel design and with belt arm guide that can be fixed.

Special features:

- With asymmetrical arms for flush lateral grinding.

Width x roll dia. [mm]	Suitable belt width [mm]	Suitable belt length [mm]	Net weight [kg]	Item no.	Designation	Price/unit EUR
8 x 24	6, 10, 12	480	0.070	90002116	BSVA 5/155-8/24x480	-



Belt grinder attachment arm BSVA 5/155-23/24x480

Belt grinder attachment arm in robust steel design and with belt arm guide that can be fixed.

Special features:

- Use of the full roller width.

Width x roll dia. [mm]	Suitable belt width [mm]	Suitable belt length [mm]	Net weight [kg]	Item no.	Designation	Price/unit EUR
23 x 24	25	480	0.088	90002117	BSVA 5/155-23/24x480	-



Belt grinder attachment arm BSVA 5/155-4/16x610

Belt grinder attachment arm in robust steel design and with belt arm guide that can be fixed.

Special features:

- With slim fixing lugs on the facing roller.

Width x roll dia. [mm]	Suitable belt width [mm]	Suitable belt length [mm]	Net weight [kg]	Item no.	Designation	Price/unit EUR
4 x 16	6	610	0.070	90002152	BSVA 5/155-4/16x610	-



Belt grinder attachment arm BSVA 5/155-9/16x610

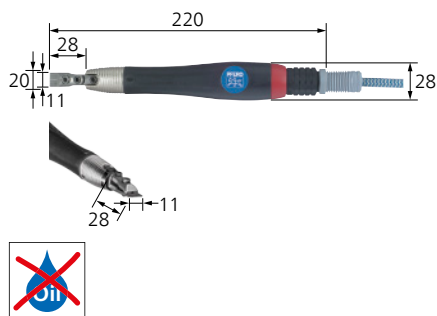
Belt grinder attachment arm in robust steel design and with belt arm guide that can be fixed.

Special features:

- With slim fixing lugs on the facing roller.

Width x roll dia. [mm]	Suitable belt width [mm]	Suitable belt length [mm]	Net weight [kg]	Item no.	Designation	Price/unit EUR
9 x 16	6, 10, 12	610	0.132	90002151	BSVA 5/155-9/16x610	-





PFGA 07/220

Air-powered filing machine with exhaust directed to the rear for work on surfaces and in hard-to-reach areas. The drive has a ring throttle version.



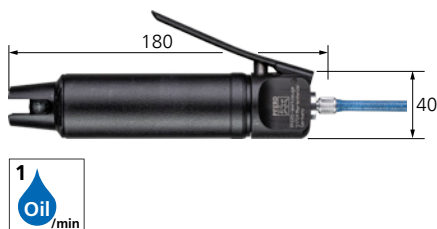
Contents:

0.32 m exhaust hose and 1.5 m air supply hose with 1/4" female threaded connection and threaded quick coupling (STGA), 1 key (SKS SW 2.5 mm), arbor.

Special features:

- Light and easy to handle.
- Tool mountings: Round shank dia. 3 mm slot mounting (L x W x D) 10 x 1.5 x 10 mm for ceramic fibre files.

Frequency [strokes/min]	Stroke length [mm]	Air consumption at idle [m ³ /min]	Air consumption under load [m ³ /min]	Air supply hose internal dia. [mm]	Net weight [kg]	Item no.	Designation	Price/unit EUR
22,000	0.7	0.05	0.03	4	0.180	80600200	PFGA 07/220	-



PF 8/90 HV

Sophisticated air-powered filing machine with exhaust directed to the front and dead man's switch using lever throttle. Suitable for files with a round shank.

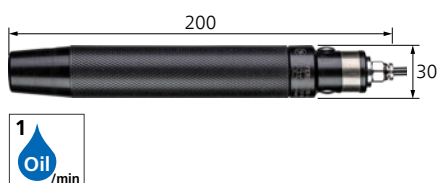
Contents:

1.5 m air supply hose with 1/4" male threaded connection and threaded quick coupling (STGI), 1 key (SF 24 STG-IG 1/4).

Special features:

- **Tool mounting dia. 4 mm to 6 mm.**
- Smooth running and very precise.
- Very low vibrations.

Frequency [strokes/min]	Stroke length [mm]	Air consumption at idle [m ³ /min]	Air consumption under load [m ³ /min]	Air supply hose internal dia. [mm]	Net weight [kg]	Item no.	Designation	Price/unit EUR
9,000	8	0.078	0.078	4.8	1.038	80600205	PF 8/90 HV	-



PF 4/84 SV

Sophisticated air-powered filing machine with exhaust directed to the front and push-pull throttle for convenient continuous use. Suitable for files with a round shank, ceramic fibre files and grinding stones.

Contents:

1.5 m air supply hose with 1/4" male threaded connection and threaded quick coupling (STGI), 1 key (SKS SW 3 mm).

Special features:

- **Tool mounting dia. 3 mm to 4 mm.**
- Smooth running and very precise.
- Very low vibrations.

Frequency [strokes/min]	Stroke length [mm]	Air consumption at idle [m ³ /min]	Air consumption under load [m ³ /min]	Air supply hose internal dia. [mm]	Net weight [kg]	Item no.	Designation	Price/unit EUR
8,400	4	0.03	0.03	3	0.300	80600210	PF 4/84 SV	-



AD PF 4.5/4.0

Adapter for filing machine.

Net weight [kg]	Item no.	Designation	Price/unit EUR
0.009	87200306	AD PF 4.5/4.0	-



MST 32 DV

Compressed-air marking pen with exhaust directed to the front, ring throttle version and very high stroke frequency. For applying markings and labels on metal, glass, plastics. Easy guidance thanks to slim design.



Contents:

2.5 m air supply hose with 1/4" male threaded connection and threaded quick coupling (STGI), TC engraving needle.

Special features:

- F type with fine engraving needle suitable for applying markings and labels on hardened tool steel.
- M type with medium engraving needle.
- G type with coarse engraving needle.

Frequency [strokes/min]	Air consumption at idle [m ³ /min]	Air consumption under load [m ³ /min]	Air supply hose internal dia. [mm]	Net weight [kg]	Item no.	Designation	Price/unit EUR
32,000	0.03	0.02	4	0.152	80600130	MST 32 DV F	-
					80600150	MST 32 DV G	-
					80600140	MST 32 DV M	-

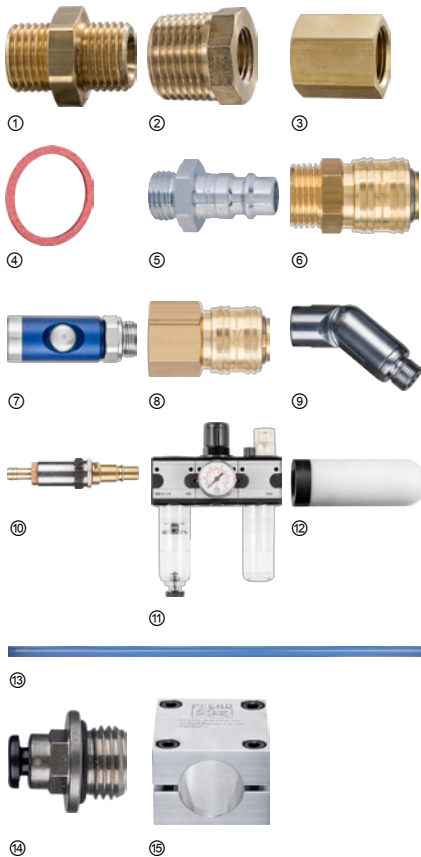


Replacement TC engraving needles for marking pens

Tungsten carbide engraving needles for marking pens. For applying markings and labels on metal, glass, plastics and on hardened tool steel.

Needle tip	Net weight [kg]	Item no.	Designation	Price/unit EUR
F (fine)	0.003	98980364	HM-GN MST32 F	-
G (coarse)	0.003	98980366	HM-GN MST32 G	-
M (medium)	0.003	98980365	HM-GN MST32 M	-





Fittings for air grinders

PFERD offers different connecting fittings for air grinders.

Image	Net weight [kg]	Item no.	Designation	Price/unit EUR
Double nipple				
(1)	0.019	80801145	DNA 1/4-1/4	-
	0.063	80801150	DNA 1/2-1/2	-
Reducing nipple				
(2)	0.008	80801163	RNI 1/2 x 1/4	-
Threaded nut				
(3)	0.076	80801154	GWI 1/2-1/2	-
Sealing ring				
(4)	0.001	90000509	DR 1/8"	-
		90000510	DR 1/4"	-
		90000512	DR 1/2"	-
Threaded quick coupling				
(5)	0.105	80900004	STGA 1/2 NW12	-
	0.040	80900801	STGA 1/2-16/AC	-
Self-closing valve couplings with male thread				
(6)	0.062	80801065	VKA 1/4	-
	0.072	80801070	VKA 1/2	-
	0.313	80801066	VKA 1/2 NW12	-
	0.123	80801048	SVKA 1/4 DK	-
	0.150	80801049	SVKA 1/2 DK	-
Self-closing valve couplings with female thread				
(7)	0.077	80801080	VKI 1/4	-
	0.083	80801085	VKI 1/2	-

Continued on next page

Image	Net weight [kg]	Item no.	Designation	Price/unit EUR
Accessory for robot spindle – quick coupling				
(13)	0.010	80900431	BK 4MM - 1-4"	-
		80900427	BK 6mm - 1-4"	-
	0.011	80900428	BK 8 mm - 1/4"	-
	0.016	80900432	BK 10 mm - 1/4"	-
	0.022	80900429	BK 12 mm - 1/4"	-
	0.098	80900433	BK 14 mm - 1/2"	-
Accessory for robot spindle – air supply hose				
(12)	0.098	98980378	PLS 4 RS	-
		98980379	PLS 6 RS	-
		98980380	PLS 8 RS	-
		98980381	PLS 10 RS	-
		98980382	PLS 12 RS	-
		98980383	PLS 14 RS	-
Accessory for robot spindle – bottom flange				
(14)	0.239	98980641	FF 30	-
	0.438	98980642	FF 36	-
	0.383	98980643	FF 41,5	-
	0.378	98980644	FF 42	-
	1.036	98980645	FF 46	-
	1.686	98980646	FF 60	-
In-line fine filter				
(9)	0.117	80807045	SF 24 STG-IG 1/4	-
	0.098	80807055	SF 30 STG-IG 1/2	-
	0.125	80807060	SF 35 IG1/2-IG1/2	-
Maintenance unit				
(10)	2.302	80802010	ONG-A 1/4	-
	0.944	80803005	ONG-A 1/2	-
Revolving nozzle				
(8)	0.125	80800050	DGT 1/2	-
Frequency damper				
(11)	0.060	87200216	FD 47-8-28 ID	-



RCK STG 10/800 control device

Control device that enables different handpieces to be actuated precisely. Achieves a maximum rotational speed of 80,000 RPM and keeps it stable during operation.



Special features:

- Equipped with intelligent control electronics.
- Comes with a sturdy design.
- Can run on battery power or with a power supply unit.

Max. RPM [RPM]	Max. power consumption [watts]	Max. power output [watts]	Max. supply voltage [volts]	Net weight [kg]	Item no.	Designation	Price/unit EUR
80,000	1,560	1,000	50.4 – 58.8	4.930	83001000	RCK STG 10/800	-

Handpieces for RCK system



Handpiece RCK GS 2/800 SP

The RCK handpiece has a brushless motor with a very stable speed and improved ergonomics.



Contents:

2 keys (1x MIM SPS DK D 7, 1x MIM ARS HA D 23.5 mm), 3 mm collet, 1.8 m handpiece cable.

Special features:

- Slim and lightweight design as well as automatic speed limitation.
- Very high concentricity speed and very quiet.
- Start interlock without clamped tool.

[RPM]	Power output [watts]	Max. voltage [volts]	Collet group	Net weight [kg]	Item no.	Designation	Price/unit EUR
Straight handpieces							
80,000 – 40,000	180	58	17	0.330	83002001	RCK GS 2/800 SP	-



Handpiece RCK GS 2/600 Z-SP

The RCK handpiece has a brushless motor with a very stable speed and improved ergonomics.

Contents:

3 keys (1x MIM SPS DK D 7, 1x DM SW 10/10 mm, 1x BSC 2.35 mm), 3 mm collet, 1.8 m handpiece cable.

Special features:

- Slim and lightweight design as well as automatic speed limitation.
- Very high concentricity speed and very quiet.
- Start interlock without clamped tool.

[RPM]	Power output [watts]	Max. voltage [volts]	Collet group	Net weight [kg]	Item no.	Designation	Price/unit EUR
60,000 – 30,000	150	58	17	0.260	83002002	RCK GS 2/600 Z-SP	-





Handpiece RCK GS 2/600 SP

The RCK handpiece has a brushless motor with a very stable speed and improved ergonomics.

Contents:

2 keys (1x MIM SPS DK D 7, 1x MIM ARS HA D 23.5 mm), 3 mm collet, 1.8 m handpiece cable.

Special features:

- Slim and lightweight design as well as automatic speed limitation.
- Very high concentricity speed and very quiet.
- Start interlock without clamped tool.

[RPM]	Power out-put [watts]	Max. voltage [volts]	Collet group	Net weight [kg]	Item no.	Designation	Price/unit EUR
60,000 – 30,000	150	58	17	0.315	83002003	RCK GS 2/600 SP	-



Handpiece RCK GS 2/600

The RCK handpiece has a brushless motor with a very stable speed and improved ergonomics.

Contents:

2 keys (1x DM SW 10/10 mm, 1x MIM DSTS SW 11x D 2.4 mm), 3 mm collet, 1.8 m hand-piece cable.

Special features:

- Slim and lightweight design as well as automatic speed limitation.
- Very high concentricity speed and very quiet.

[RPM]	Power out-put [watts]	Max. voltage [volts]	Collet group	Net weight [kg]	Item no.	Designation	Price/unit EUR
60,000 – 30,000	150	58	19	0.393	83002004	RCK GS 2/600	-



Handpiece RCK GSP 2/500 V-SP

The RCK handpiece has a brushless motor with a very stable speed and improved ergonomics.

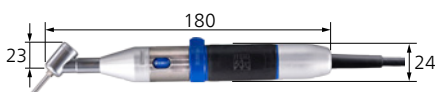
Contents:

2 keys (1x MIM ARS HA D 23.5 mm, 1x MIM SPS DK D 7), 3 mm collet, 1.8 m handpiece cable.

Special features:

- Slim and lightweight design as well as automatic speed limitation.
- Very high concentricity speed and very quiet.
- Start interlock without clamped tool.

[RPM]	Power out-put [watts]	Max. voltage [volts]	Collet group	Net weight [kg]	Item no.	Designation	Price/unit EUR
50,000 – 25,000	150	58	17	0.325	83002005	RCK GS 2/500 V-SP	-



Handpiece RCK WS 1/300 45°

The RCK handpiece has a brushless motor with a very stable speed and improved ergonomics.

Contents:

2 keys (1x MIM ARH, 1x DM SW 4/4 mm), 3 mm collet, 1.8 m handpiece cable.

Special features:

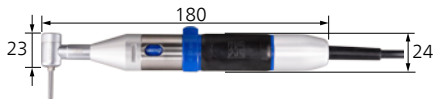
- Slim and lightweight design as well as automatic speed limitation.
- Very high concentricity speed and very quiet.

[RPM]	Power output [watts]	Max. voltage [volts]	Collet group	Net weight [kg]	Item no.	Designation	Price/unit EUR
30,000 – 15,000	120	58	18	0.243	83003002	RCK WS 1/300 45°	-



RCK drive systems

Handpieces for RCK system



Handpiece RCK WS 1/300 90°

The RCK handpiece has a brushless motor with a very stable speed and improved ergonomics.

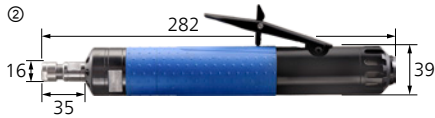
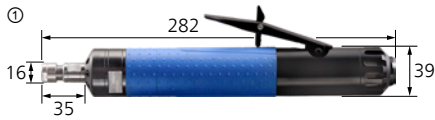
Contents:

2 keys (1x MIM ARH, 1x DM SW 4/4 mm),
3 mm collet, 1.8 m handpiece cable.

Special features:

- Slim and lightweight design as well as automatic speed limitation.
- Very high concentricity speed and very quiet.

[RPM]	Power output [watts]	Max. voltage [volts]	Collet group	Net weight [kg]	Item no.	Designation	Price/unit EUR
30,000 – 15,000	120	58	18	0.245	83003001	RCK WS 1/300 90°	-



RCK handpieces in sturdy design

The RCK handpieces have a brushless motor with a very stable speed and improved ergonomics.



Contents:

2 keys, 6 mm collet, 2 m handpiece cable.

Special features:

- Unique, sturdy design for particularly quiet working.

Image	[RPM]	Power output [watts]	Max. voltage [volts]	Collet group	Net weight [kg]	Item no.	Designation	Price/unit EUR
(1)	40,000 – 20,000	380	58	21	0.885	83004001	RCK GS 4/400	-
(2)	10,000 – 5,000	380	58	21	0.877	83004002	RCK GS 4/100	-

Accessories for RCK system



High-performance rechargeable battery RCK BAT

High-performance rechargeable battery with 50.4 V nominal voltage.



Special features:

- Work safely with safety extra-low voltage.
- Overload protection.

Cell type	Nominal voltage [volts]	Nominal capacity [Ah]	Energy [Wh]	Net weight [kg]	Item no.	Designation	Price/unit EUR
Lithium-ion	50.4	5.6	282.24	1.950	98990001	RCK BAT	-



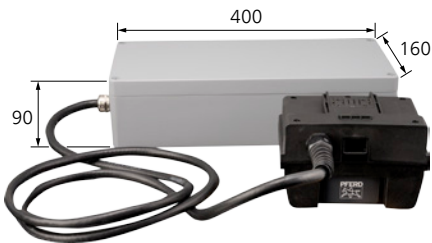


Rapid charger RCK SL

Rapid charger with universal IEC power connector.

Contents:
2 m power cable.

Input voltage [VAC]	Frequency [Hz]	Max. power consumption [watts]	Max. charging current [A]	Net weight [kg]	Item no.	Designation	Price/unit EUR
100 – 240	50 – 60	300	4.6	1.219	98990010	RCK SL	-



Electronic power supply unit RCK NT

Electronic power supply unit with universal IEC power connector and dust-protected housing.

Contents:
2 m power cable.



Input voltage [V/V]	Nominal current [A/A]	Frequency [Hz]	Nominal voltage [volts]	Net weight [kg]	Item no.	Designation	Price/unit EUR
120 / 240	9 / 6.5	50 – 60	57.5	5.610	98990020	RCK NT	-



Foot switch RCK FU-R

Vario foot switch which can be connected on the rear of the RCK control device and can be used to control the rotational speed of the RCK handpieces.

Net weight [kg]	Item no.	Designation	Price/unit EUR
0.845	98990030	RCK FU-R	-



Foot switch RCK FU-E/A

On/off foot switch which can be connected on the rear of the RCK control device and can be used to switch the RCK handpieces on and off.

Net weight [kg]	Item no.	Designation	Price/unit EUR
0.310	98990031	RCK FU-E/A	-



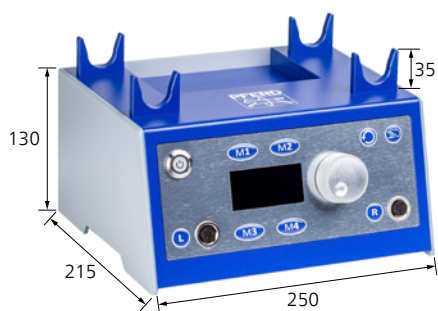


RCK connecting cable AK 1.5/2/3/5

RCK connecting cable measuring 1.5; 2; 3 and 5 metres for the use of RCK handpieces.

Length [m]	Net weight [kg]	Item no.	Designation	Price/unit EUR
1.5	0.196	98990040	RCK AK 1.5M	-
2	0.246	98990041	RCK AK 2M	-
3	0.346	98990042	RCK AK 3M	-
5	0.546	98990043	RCK AK 5M	-





MIM STG3S 3/800

Micro motor control device with high power stability for steplessly controlling the rotational speed of micro motor handpieces. The rotational speed control can be provided by hand or via foot switch.

Contents:

2 m power cable, 2 handpiece supports.

Special features:

- Max. 80,000 RPM clockwise rotation, max. 30,000 RPM anti-clockwise rotation.

- 2 switchable connection sockets for micro motor handpieces.
- 4 free rotational speed storage spaces per connected handpiece.

For micro motor handpieces [RPM]	Power output [watts]	Voltage [volts] 50–60 Hz	Output voltage [volts]	Net weight [kg]	Item no.	Designation	Price/unit EUR
80,000 – 1,000	350	230	50	2.980	83000025	MIM STG3S 3/800 230 V	-



MIM STG2S 3/600

Micro motor control device with high power stability for controlling the rotational speed of micro motor handpieces. Stepless rotational speed control can be provided by hand or via foot switch.

Contents:

2 m power cable, 2 handpiece supports.

Special features:

- Max. 60,000 RPM clockwise rotation, max. 30,000 RPM anti-clockwise rotation.

For micro motor handpieces [RPM]	Power output [watts]	Voltage [volts] 50–60 Hz	Output voltage [volts]	Net weight [kg]	Item no.	Designation	Price/unit EUR
60,000 – 1,000	260	230	36	2.338	83000020	MIM STG2S 3/600 230 V	-

Micro motor handpieces



Micro motor handpiece MIM HAS 3/800 SP3

Micro motor handpiece with high power stability, very high rotation accuracy and brushless motor.

Contents:

2 keys (1x MIM ARS HA D 23.5 mm, 1x MIM SPS DK D 7), 3 mm collet, 1.8 m handpiece cable.

Special features:

- Automatic speed limitation.
- Start interlock without clamped tool.
- Extremely energy-efficient and quiet in comparison to air grinders.

Rotational speed [RPM]	Power consumption [watts]	Power output [watts]	Low voltage [volts]	Collet group	Net weight [kg]	Item no.	Designation	Price/unit EUR
Compatible with STG3S								
80,000 – 1,000	350	180	50	17	0.330	83000120	MIM HAS 3/800 SP3	-





Micro motor handpiece MIM HAS 2/600 SP3

Micro motor handpiece with high power stability, very high rotation accuracy and brushless motor.

Contents:

3 keys (1x MIM SPS DK 7, 1x MIM ARS HA 23.5 mm, 1x BSC 2.35 mm), 3 mm collet, 1.8 m handpiece cable.

Special features:

- Automatic speed limitation.
- Start interlock without clamped tool.
- Extremely energy-efficient and quiet in comparison to air grinders.

Rotational speed [RPM]	Power consumption [watts]	Power output [watts]	Low voltage [volts]	Collet group	Net weight [kg]	Item no.	Designation	Price/unit EUR
Compatible with STG3S and STG2S								
60,000 – 1,000	260	150	36 / 50	17	0.260	83000102	MIM HAS 2/600 SP3	-



Micro motor handpiece MIM HAS 3/600 SP3

Micro motor handpiece with high power stability, very high rotation accuracy and brushless motor.

Contents:

2 keys (1x MIM ARS HA D 23.5 mm, 1x MIM SPS DK D 7), 3 mm collet, 1.8 m handpiece cable.

Special features:

- Automatic speed limitation.
- Start interlock without clamped tool.
- Extremely energy-efficient and quiet in comparison to air grinders.

Rotational speed [RPM]	Power consumption [watts]	Power output [watts]	Low voltage [volts]	Collet group	Net weight [kg]	Item no.	Designation	Price/unit EUR
60,000 – 1,000	260	150	36 / 50	17	0.315	83000103	MIM HAS 3/600 SP3	-



Micro motor handpiece MIM HAS 3/600 S3

Micro motor handpiece with high power stability, very high rotation accuracy and brushless motor.

Contents:

2 keys (1x DM SW 10/10 mm, 1x MIM DSTS SW 11x D 2.4 mm), 3 mm collet, 1.8 m handpiece cable.

Special features:

- Automatic speed limitation.
- Extremely energy-efficient and quiet in comparison to air grinders.

Rotational speed [RPM]	Power consumption [watts]	Power output [watts]	Low voltage [volts]	Collet group	Net weight [kg]	Item no.	Designation	Price/unit EUR
60,000 – 1,000	260	150	36 / 50	19	0.393	83000110	MIM HAS 3/600 S3	-



Micro motor handpiece MIM HAS 3/500 VS-SP3

Micro motor handpiece with high power stability, very high rotation accuracy and brushless motor.

Contents:

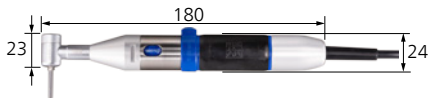
2 keys (1x MIM ARS HA D 23.5 mm, 1x MIM SPS DK D 7), 3 mm collet, 1.8 m handpiece cable.

Special features:

- Automatic speed limitation.
- Start interlock without clamped tool.
- Extremely energy-efficient and quiet in comparison to air grinders.

Rotational speed [RPM]	Power consumption [watts]	Power output [watts]	Low voltage [volts]	Collet group	Net weight [kg]	Item no.	Designation	Price/unit EUR
50,000 – 1,000	260	150	36 / 50	17	0.325	83000105	MIM HAS 3/500 VS-SP3	-





Micro motor handpiece MIM WZS 3/300 90° S3

Micro motor handpiece with high power stability, very high rotation accuracy and brushless motor.

Contents:

2 keys (1x MIM ARH, 1x DM SW 4/4 mm),
3 mm collet, 1.8 m handpiece cable.

Special features:

- Automatic speed limitation.
- Extremely energy-efficient and quiet in comparison to air grinders.

Rotational speed [RPM]	Power consumption [watts]	Power output [watts]	Low voltage [volts]	Collet group	Net weight [kg]	Item no.	Designation	Price/unit EUR
30,000 – 1,000	260	120	36 / 50	18	0.238	83000150	MIM WZS 3/300 90° S3	-



Micro motor handpiece MIM WZS 3/300 45° S3

Micro motor handpiece with high power stability, very high rotation accuracy and brushless motor.

Contents:

2 keys (1x MIM ARH, 1x DM SW 4/4 mm),
3 mm collet, 1.8 m handpiece cable.

Special features:

- Automatic speed limitation.
- Extremely energy-efficient and quiet in comparison to air grinders.

Rotational speed [RPM]	Power consumption [watts]	Power output [watts]	Low voltage [volts]	Collet group	Net weight [kg]	Item no.	Designation	Price/unit EUR
30,000 – 1,000	260	120	36 / 50	18	0.185	83000160	MIM WZS 3/300 45° S3	-

Accessories for micro motor systems

Accessories for micro motor systems

PFERD offers a Vario micro motor foot switch for stepless rotational speed control, a micro motor foot switch for switching on and off, and a 3 m micro motor extension cable for handpieces as accessories for micro motor systems.

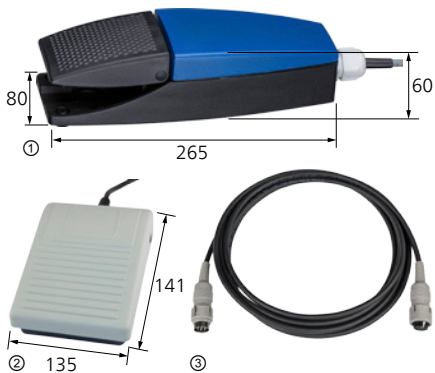
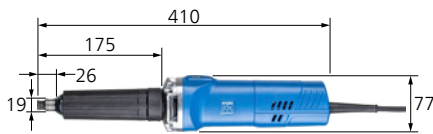


Image	Net weight [kg]	Item no.	Designation	Price/unit EUR
Vario foot switch MIM FU-R				
(1)	0.845	83000070	MIM FU-R	-
On/off foot switch MIM FU-E/A				
(2)	0.310	83000080	MIM FU-E/A	-
Extension cable MIM VLK HAS/WZS 3 m				
(3)	0.152	90014007	MIM VLK HAS/WZS 3M	-



Electric grinders

Straight grinder



EGER 8/280

Electric straight grinder which meets the highest technical standards and incorporates the latest ergonomic findings and requirements. The digital electronics enable a constant rotational speed to be maintained.

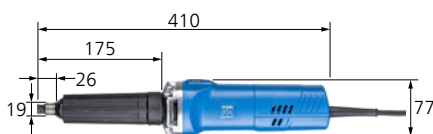
Contents:

4 m power cable, 6 mm collet (collet group 22), 2 keys (1x EM SW 13 mm, 1x EM SW 17 mm).

Special features:

- Stepless rotational speed regulation.
- Overload protection.
- Smooth start-up to protect people, tools and the drive.

RPM	Power consumption [watts]	Power output [watts]	Voltage [volts] 50–60 Hz	Net weight [kg]	Item no.	Designation	Price/unit EUR
28,000 – 8,500	750	410	230	1.800	83108280	EGER 8/280	-



EGER 8/280 E

Electric straight grinder with elastic bearing; meets the highest technical standards and incorporates the latest ergonomic findings and requirements. The digital electronics enable a constant rotational speed to be maintained.

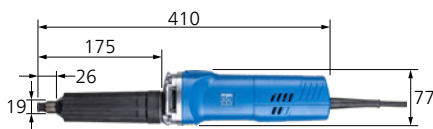
Contents:

4 m power cable, 6 mm collet (collet group 22), 2 keys (1x EM SW 13 mm, 1x EM SW 17 mm).

Special features:

- Stepless rotational speed regulation.
- Overload protection.
- Smooth start-up to protect people, tools and the drive.

RPM	Power consumption [watts]	Power output [watts]	Voltage [volts] 50–60 Hz	Net weight [kg]	Item no.	Designation	Price/unit EUR
28,000 – 8,500	750	410	230	1.800	83108290	EGER 8/280 E	-



EGER 8/90

Electric straight grinder which meets the highest technical standards and incorporates the latest ergonomic findings and requirements. The digital electronics enable a constant rotational speed to be maintained.

Contents:

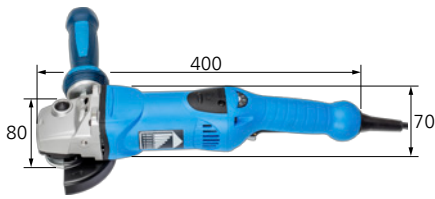
4 m power cable, 6 mm collet (collet group 22), 2 keys (1x EM SW 13 mm, 1x EM SW 17 mm).

Special features:

- Stepless rotational speed regulation.
- Overload protection.
- Smooth start-up to protect people, tools and the drive.

RPM	Power consumption [watts]	Power output [watts]	Voltage [volts] 50–60 Hz	Net weight [kg]	Item no.	Designation	Price/unit EUR
9,000 – 2,500	710	410	230	1.800	83108090	EGER 8/90	-





UWER 18/120 SI

Electric angle grinder with M14 drive spindle thread and tool mounting hole dia. 22.23 mm. Max. tool diameter up to 115 mm.

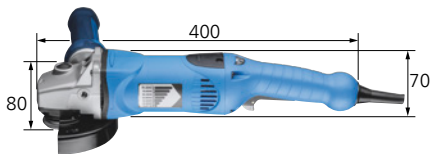
Contents:

4 m power cable, 1 clamping flange (item no. 98970043), 1 quick-mounting nut (item no. 98970042), 1 surface guard dia. 115 mm, anti-vibration handle.

Special features:

- With robust design for heavy-duty use, spindle lock pin, stepless rotational speed control and digital electronics for a constant rotational speed.
- With overload protection with anti-kick-back function and lateral anti-vibration handle.
- Smooth start-up to protect people, tools and the drive and lockable on/off switch.

RPM	Power consumption [watts]	Power output [watts]	Voltage [volts] 50–60 Hz	Net weight [kg]	Item no.	Designation	Price/unit EUR
11,500 – 2,800	1,750	1,150	230	2.800	83500200	UWER 18/120 SI	-



UWER 18/110 SI

Electric angle grinder with M14 drive spindle thread and tool mounting hole dia. 22.23 mm. Max. tool diameter up to 125 mm.

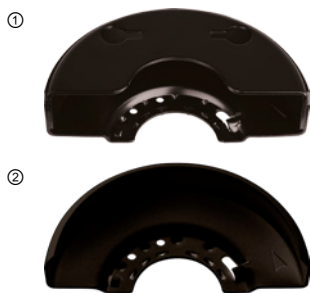
Contents:

4 m power cable, 1 clamping flange (item no. 98970043), 1 quick-mounting nut (item no. 98970042), 1 surface guard dia. 125 mm, anti-vibration handle.

Special features:

- With robust design for heavy-duty use, spindle lock pin, stepless rotational speed control and digital electronics for a constant rotational speed.
- With overload protection with anti-kick-back function and lateral anti-vibration handle.
- Smooth start-up to protect people, tools and the drive and lockable on/off switch.

RPM	Power consumption [watts]	Power output [watts]	Voltage [volts] 50–60 Hz	Net weight [kg]	Item no.	Designation	Price/unit EUR
11,000 – 2,700	1,750	1,150	230	2.800	83500250	UWER 18/110 SI	-



Guards

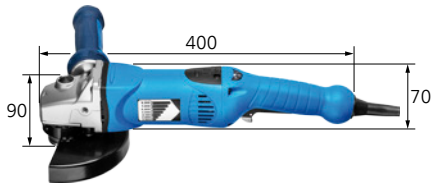
PFERD offers various guards.

Image	Net weight [kg]	Item no.	Designation	Price/unit EUR
(1)	0.325	98970071	H45-115 HT-SV	-
	0.351	84108000	H45-125 HT-SV	-
(2)	0.160	98970072	H45-115 FL-SV	-
	0.164	84108010	H45-125 FL-SV	-



Electric grinders

Angle grinder



UWER 18/95 SI

Electric angle grinder with M14 drive spindle thread and tool mounting hole dia. 22.23 mm. Max. **tool diameter up to 150 mm.**

Contents:

4 m power cable, 1 clamping flange (item no. 98970043), 1 quick-mounting nut (item no. 98970042), 1 surface guard dia. 150 mm, anti-vibration handle.

Special features:

- With robust design for heavy-duty use, spindle lock pin, stepless rotational speed control and digital electronics for a constant rotational speed.
- With overload protection with anti-kick-back function and lateral anti-vibration handle.
- Smooth start-up to protect people, tools and the drive and lockable on/off switch.

RPM	Power consumption [watts]	Power output [watts]	Voltage [volts] 50–60 Hz	Net weight [kg]	Item no.	Designation	Price/unit EUR
9,500 – 2,300	1,750	1,150	230	3.000	83500300	UWER 18/95 SI	-



Guards

PFERD offers various guards.

Image	Net weight [kg]	Item no.	Designation	Price/unit EUR
(1)	0.491	84108030	H51-150 HT-SV	-
(2)	0.450	84108020	H51-150 FL-SV	-



EWER 17/75

Electric angle grinder with M14 drive spindle thread and tool mounting hole dia. 22.23 mm. Max. **tool diameter up to 125 mm.**

Contents:

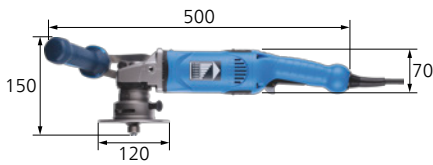
4 m power cable, 1 key (STL SW 35 x 5.3 mm), 1 clamping flange (item no. 98960180), 1 quick-mounting nut (item no. 98960181), 1 surface guard dia. 125 mm, anti-vibration handle.

Special features:

- With spindle lock pin, stepless rotational speed control and digital electronics for a constant rotational speed.
- Adjusted rotational speed range for tools with low cutting speeds.
- With smooth start-up to protect people, tools and the drive as well as overload protection.

RPM	Power consumption [watts]	Power output [watts]	Voltage [volts] 50–60 Hz	Net weight [kg]	Item no.	Designation	Price/unit EUR
7,500 – 2,700	1,700	1,000	230	2.810	83500350	EWER 17/75	-





UWER 18/110 EF

Electric grinder which meets the highest technical standards and incorporates the latest ergonomic findings and requirements. With M14 drive spindle thread. Max. chamfer height of 6 mm.

Contents:

4 m power cable, 3 keys (1x SKS SW 5 mm, 1x HS 40-42, 1x SDR TX 15K), anti-vibration handle.

Special features:

- With spindle lock pin, stepless rotational speed control and digital electronics for a constant rotational speed.
- Smooth start-up to protect people, tools and the drive and lockable on/off switch.

RPM	Power consumption [watts]	Power output [watts]	Voltage [volts] 50-60 Hz	Net weight [kg]	Item no.	Designation	Price/unit EUR
Incl. cutting insert holder							
11,000 – 2,750	1,750	1,150	230	7.360	83500980	EDGE FINISH UWER 18/110 EF-R3/45° TK	-
					83500990	EDGE FINISH UWER 18/110 EF-30° TK	-
Excl. cutting insert holder							
11,000 – 2,750	1,750	1,150	230	3.640	83501000	EDGE FINISH UWER 18/110 EF	-

Burnishing machine



ESER 17/75

Electric burnishing machine with two keyways for increased power transmission on drum tools. With stepless rotational speed control and drive spindle with CD-R mounting for felt discs diameter 50 mm to protect the tool. With **tool mounting dia. x width 19 x 100 mm**.



Contents:

4 m power cable, hand guard, anti-vibration handle, detachable drive spindle.

Special features:

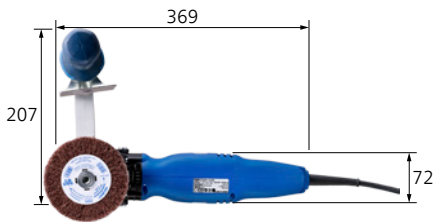
- With spindle lock pin, stepless rotational speed control and digital electronics for a constant rotational speed.
- M14 drive spindle for mounting drum tools with female thread.
- With smooth start-up to protect people, tools and the drive as well as overload protection.

RPM	Power consumption [watts]	Power output [watts]	Voltage [volts] 50-60 Hz	Net weight [kg]	Item no.	Designation	Price/unit EUR
7,500 – 2,700	1,700	1,000	230	3.065	83300260	ESER 17/75	-



Electric grinders

Burnishing machine



ESER 12/25

Low-speed electric burnishing machine with high torque and stepless rotational speed control. Has a drive spindle with CD-R mounting for felt discs diameter 50 mm to protect the tool. With **tool mounting dia. x width 19 x 100 mm**.



Contents:

4 m power cable, hand guard, anti-vibration handle, detachable drive spindle.

Special features:

- With spindle lock pin and digital electronics for a constant rotational speed as well as two keyways for increased power transmission on drum tools.
- M14 drive spindle for mounting drum tools with female thread.
- With smooth start-up to protect people, tools and the drive as well as overload protection.

RPM	Power consumption [watts]	Power output [watts]	Voltage [volts] 50–60 Hz	Net weight [kg]	Item no.	Designation	Price/unit EUR
2,500 – 900	1,200	750	230	3.340	83300270	ESER 12/25	-

Belt grinders and belt arms



EBER 8/280

Electric belt grinder with a **belt length of 520 mm (*610 mm) x width 3 – 20 mm**. The belt arm can be changed without a key. With stepless rotational speed control.

Contents:

4 m power cable, 1 belt arm BSVA 9/24 x 520 (belt grinder attachment arm group 4), protective cover SDVH.

Special features:

- *Possible with an **EBSA 610 adapter**.
- Digital electronics for constant rotational speed and overload protection.
- Smooth start-up to protect people, tools and the drive.

Belt speed [m/s]	Power consumption [watts]	Power output [watts]	Voltage [volts] 50–60 Hz	Net weight [kg]	Item no.	Designation	Price/unit EUR
32 – 12	800	550	230	2.100	83208280	EBER 8/280	-



Adapter for belt grinder attachment arm group 4

Enables the use of belts with a **belt length of 610 mm and a belt width of 3 – 20 mm**.

Suitable belt length [mm]	Net weight [kg]	Item no.	Designation	Price/unit EUR
610	0.075	84200700	EBSA 610	-



Protective cover for EBER 8/280

PFERD offers protective covers for PFERD belt grinders.

Net weight [kg]	Item no.	Designation	Price/unit EUR
0.051	98960081	SDVH	-





Belt grinder attachment arm BSVA 4/18

Belt grinder attachment arm in robust design allowing easy, quick belt replacement due to spring clamping. The belt grinder attachment can be pivoted on the respective drive system or handpiece and therefore allows flexible adaptation to each individual work situation.

Special features:

- Suitable for surface work.
- Use of the full roller width.
- Extremely slim fixing lugs on the facing roller.

Width x roll dia. [mm]	Suitable belt width [mm]	Suitable belt length [mm]	Net weight [kg]	Item no.	Designation	Price/unit EUR
4 x 18	3, 6, 9	520, 610	0.060	84200702	BSVA 4/18x520	-



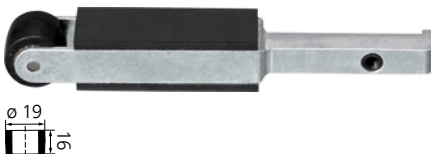
Belt grinder attachment arm BSVA 9/24

Belt grinder attachment arm in robust design allowing easy, quick belt replacement due to spring clamping. The belt grinder attachment can be pivoted on the respective drive system or handpiece and therefore allows flexible adaptation to each individual work situation.

Special features:

- Suitable for universal use.
- Extremely slim fixing lugs on the facing roller.

Width x roll dia. [mm]	Suitable belt width [mm]	Suitable belt length [mm]	Net weight [kg]	Item no.	Designation	Price/unit EUR
9 x 24	3, 6, 9, 12, 16	520, 610	0.073	84200701	BSVA 9/24x520	-



Belt grinder attachment arm BSVA 16/19

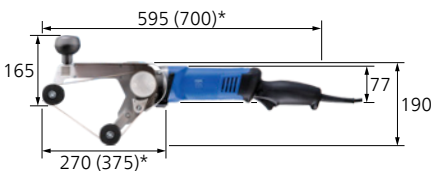
Belt grinder attachment arm in robust design allowing easy, quick belt replacement due to spring clamping. The belt grinder attachment can be pivoted on the respective drive system or handpiece and therefore allows flexible adaptation to each individual work situation.

Special features:

- Suitable for surface work.
- Use of the full roller width.
- Extremely slim fixing lugs on the facing roller.

Width x roll dia. [mm]	Suitable belt width [mm]	Suitable belt length [mm]	Net weight [kg]	Item no.	Designation	Price/unit EUR
16 x 19	12, 16	520, 610	0.100	84200703	BSVA 16/19x520	-

Pipe belt grinder



EBER 17/75 R

Electric pipe belt grinder with a **belt length of 610 – 820 mm x width 12 – 40 mm**. The lockable guide roller ensures greater contact pressure or a large surface contact angle.



Contents:

- 4 m power cable, 1 key (SKHS SW 5 mm), 4 rolls.

Special features:

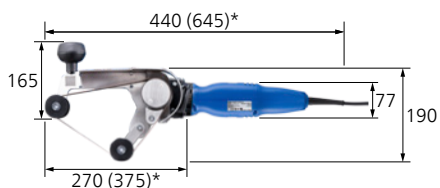
- With spindle lock pin, overload protection, stepless rotational speed control and digital electronics for a constant rotational speed.
- With telescopic arm for using different belt lengths and fixed side plates to protect the workpiece.
- Smooth start-up to protect people, tools and the drive.

Belt speed [m/s]	Power consumption [watts]	Power output [watts]	Voltage [volts] 50–60 Hz	Net weight [kg]	Item no.	Designation	Price/unit EUR
22.8 – 8.2	1,700	1,000	230	4.027	83200250	EBER 17/75 R	-



Electric grinders

Pipe belt grinder



EBER 12/25 R

Low-speed electric pipe belt grinder with a **belt length of 610 – 820 mm x width 12 – 40 mm**. With stepless rotational speed control and lockable guide roller for greater contact pressure or a large surface contact angle.



Contents:

4 m power cable, 1 key (SKHS SW 5 mm), 4 rolls.

Special features:

- With spindle lock pin and digital electronics for a constant rotational speed.
- Fixed side plates on the rolls to protect the workpiece.
- With smooth start-up to protect people, tools and the drive as well as overload protection.

Belt speed [m/s]	Power consumption [watts]	Power output [watts]	Voltage [volts] 50–60 Hz	Net weight [kg]	Item no.	Designation	Price/unit EUR
7.6 – 2.7	1,200	750	230	4.212	83200260	EBER 12/25 R	-



How to find the matching flexible shaft to your drive

Here you will find a selection of flexible shafts for the individual drives in line with the explanation below.

Flexible shafts and handpieces/attachments must always be selected according to the required rotational speed and power output. Maximum cost-effectiveness is achieved through the combination of a high-performance tool and an optimal drive.

① Drive

Alternative drives with DIN 10 connection (exceptions: DIN 15).

② Flexible shaft (BW)

Possible flexible shafts.

③ Rotational speed [RPM]

Rotational speed range of the drive system.

④ **Rotational speed range** for flexible shafts and handpieces

⑤ **Connection**

Drive-side connection DIN 10 / DIN 15 and handpiece-side connections (G16 to G28 and DPF, SRF).

⑥ **Suitable flexible shaft**

- ideally suitable
- suitable
- unsuitable



① Drive motor		EMER 8/280 BW	EMER 8/90 BW	RUER 8/180 SI	MMEW 11/120	MEW 18/240 ME 22/240	MEW 18/150 ME 22/150	MME 40/150 DIN 15
③ Rotational speed range [RPM]:		28,000–8,500	9,000–2,500	18,000–500	12,000–800	24,000–100	15,000–100	15,000–100
② Flexible shafts	④ Drive [RPM]							
BW 4 DIN 10/G16	40,000–15,000	⑥ ○	–	○	–	○	○	–
BW 4 PST-T DIN 10 ⑤	7,650– 1,500	–	●	●	●	○	○	–
BW 6 DIN 10/G16	25,000–11,000	●	–	●	○	●	○	–
BW 6 DIN 10/DPF	18,000– 9,000	○	–	●	○	○	○	–
BW 6 DIN 10/SRF								
BW 7 DIN 10/G22	25,000–11,000	●	–	○	○	●	○	–
BW 7 PST-T DIN 10	4,250– 1,500	–	○	○	●	○	○	–
BW 10 SE 11 DIN 10/G28	18,000– 750	○	○	–	○	●	●	–
BW 10 SE 11 DIN 15/G28	18,000– 750	○	○	–	–	–	–	●
BW 12 DIN 10/G28	12,000– 850	–	–	–	–	●	●	–
BW 12 DIN 15/G28	12,000– 850	–	–	–	–	–	–	●
FS-BW 7 DIN 10/G22	25,000–11,000	●	–	○	○	●	○	–
FS-BW 10 DIN 10/G28	18,000– 750	○	○	–	○	●	●	–
FS-BW 12 DIN 10/G28	12,000– 850	–	–	–	–	●	●	–

● = ideally suitable ○ = suitable – = unsuitable

All data is also valid for flexible shaft versions without handpieces and 2-metre versions.



Drive systems with DIN 10/DIN 15

Flexible shaft drives – EL motors for flexible shafts and accessories



EMER 8/280 BW

Electronic flexible shaft drive with stepless rotational speed control and DIN 10 flexible shaft connection. With digital electronics for constant rotational speed.



Contents:

4 m power cable, 2 keys (STS D 4 mm).

Special features:

- A pipe stand protects the drive.
- Overload protection.
- Smooth start-up to protect people, tools and the drive.

Rotational speed [RPM]	Power consumption [watts]	Power output [watts]	Voltage [volts] 50–60 Hz	Plug	Net weight [kg]	Item no.	Designation	Price/unit EUR
28,000 – 8,500	750	410	230	with	2.500	85206400	EMER 8/280 BW	-



EMER 8/90 BW

Electronic flexible shaft drive with stepless rotational speed control and DIN 10 flexible shaft connection. With digital electronics for constant rotational speed.



Contents:

4 m power cable, 2 keys (STS D 4 mm).

Special features:

- A pipe stand protects the drive.
- Overload protection.
- Smooth start-up to protect people, tools and the drive.

Rotational speed [RPM]	Power consumption [watts]	Power output [watts]	Voltage [volts] 50–60 Hz	Plug	Net weight [kg]	Item no.	Designation	Price/unit EUR
9,000 – 2,500	710	410	230	with	2.500	85206410	EMER 8/90 BW	-



Drive systems with DIN 10/DIN 15

Flexible shaft drives for Record Universal Motor and accessories



RUER 8/180 SI

Electronic flexible shaft drive with DIN 10 flexible shaft connection and robust design for heavy-duty use and stepless rotational speed control. Particularly suitable for use in tool and mould construction.

Contents:

2.5 m power cable, 2.25 m connecting cable, 2 keys (STS D 4 mm).

Special features:

- Electronics for constant rotational speed.
- Overload protection.
- Very little noise generated.

Rotational speed [RPM]	Power consumption [watts]	Power output [watts]	Voltage [volts] 50–60 Hz	Plug	Net weight [kg]	Item no.	Designation	Price/unit EUR
18,000 – 500	1,020	600	230	with	1.650	85205710	RUER 8/180 SI	-



Accessories for tool drives RUER

Table stand for attachment to bench tops up to 65 mm thick with screw clamp. The support matches the table stand and allows optimum placement of the various handpieces, ready for use.

Image	Description	Net weight [kg]	Item no.	Designation	Price/unit EUR
(1)	Table stand	2.170	86320001	TS L 1400	-
(2)	Handpiece support	0.450	86320005	TSA L 1400	-



Drive systems with DIN 10/DIN 15

Flexible shaft drives for Mini-Mammoth Electronic and accessories



MMEW 11/120

Electronic flexible shaft drive with DIN 10 flexible shaft connection and robust design for heavy-duty use, stepless rotational speed control and very little noise generated.

Contents:

2.5 m power cable, 2 keys (STS D 4 mm).

Special features:

- Most powerful and stable torque with stepless rotational speed control.
- Mounted grinding and polishing tools with diameter ≥ 60 mm are not suitable for continuous use with the Mini-Mammoth Electronic.
- With smooth start-up to protect people, tools and the drive as well as overload protection.

Rotational speed [RPM]	Power consumption [watts]	Power output [watts]	Voltage [volts] 50–60 Hz	Plug	Net weight [kg]	Item no.	Designation	Price/unit EUR
12,000 – 800	1,100	800	230	with	7.900	85205800	MMEW 11/120	-

Flexible shaft drives for Mammoth Electronic and accessories



MEW 18/240

Electronic flexible shaft drive with DIN 10 flexible shaft connection, generates very little noise and has 1-phase alternating current and high torque, even at low rotational speeds. Achieves a maximum rotational speed of 24,000 RPM.

Contents:

4 m power cable with plug, 2 Allen keys.

Special features:

- Most powerful and stable torque with stepless rotational speed control.
- Removable operating console with possibility of extension, e.g. hanging design for work in boilers.
- With smooth start-up to protect people, tools and the drive as well as overload protection.

Rotational speed	Power consumption [watts]	Power output [watts]	Voltage [volts] 50–60 Hz	Plug	Net weight [kg]	Item no.	Designation	Price/unit EUR
24,000 – 100	2,000	1,500	200 – 240	with	24.500	85202037	MEW 18/240	-



ME 22/240

Electronic flexible shaft drive with DIN 10 flexible shaft connection, generates very little noise and has 3-phase alternating current and high torque, even at low rotational speeds. Achieves a maximum rotational speed of 24,000 RPM.

Contents:

4 m power cable without plug, 2 keys (STS D 4 mm).

Special features:

- Most powerful and stable torque with stepless rotational speed control.
- Removable operating console with possibility of extension, e.g. hanging design for work in boilers.
- With smooth start-up to protect people, tools and the drive as well as overload protection.

Rotational speed	Power consumption [watts]	Power output [watts]	Voltage [volts] 50–60 Hz	Net weight [kg]	Item no.	Designation	Price/unit EUR
24,000 – 100	2,700	2,200	380 – 480	24.500	85202041	ME 22/240 400 V	-



MEW 18/150

Electronic flexible shaft drive with DIN 10 flexible shaft connection, 1-phase alternating current and high torque over the entire rotational speed range.

Contents:

4 m power cable with plug, 2 keys (STS D 4 mm).

Special features:

- Most powerful and stable torque with overload protection and stepless rotational speed control (with overdrive ST 103 DIN 10 up to max. 40,000 RPM).

- Removable operating console with possibility of extension, e.g. hanging design for work in boilers.
- Frequency inverter for maintaining constant rotational speed.

Rotational speed	Power consumption [watts]	Power output [watts]	Voltage [volts] 50–60 Hz	Plug	Net weight [kg]	Item no.	Designation	Price/unit EUR
15,000 – 100	2,000	1,500	200 – 240	with	24.500	85202036	MEW 18/150	-



ME 22/150

Electronic flexible shaft drive with DIN 10 flexible shaft connection, 3-phase alternating current and high torque over the entire rotational speed range.

Contents:

4 m power cable without plug, 2 keys (STS D 4 mm).

Special features:

- Most powerful and stable torque with overload protection and stepless rotational speed control (with overdrive ST 103 DIN 10 up to max. 40,000 RPM).

- Removable operating console with possibility of extension, e.g. hanging design for work in boilers.
- Frequency inverter for maintaining constant rotational speed.

Rotational speed	Power consumption [watts]	Power output [watts]	Voltage [volts] 50–60 Hz	Net weight [kg]	Item no.	Designation	Price/unit EUR
15,000 – 100	2,700	2,200	380 – 480	24.500	85202040	ME 22/150 400 V	-



Drive systems with DIN 10/DIN 15

Flexible shaft drives for Mammoth Electronic and accessories



Remote control cable FSTK for Mammoth Electronic

For extending the operating console.

Description	Net weight [kg]	Item no.	Designation	Price/unit EUR
Remote control cable	0.635	85202165	FSTK 22	-



Foot switch FSE 22 for Mammoth Electronic

For switching the drive on and off via the remote control interface.

Description	Net weight [kg]	Item no.	Designation	Price/unit EUR
Foot switch	1.000	85202105	FSE 22 2-POLIG	-



Base FME for Mammoth Electronic

Stable base with pivot device.

Description	Net weight [kg]	Item no.	Designation	Price/unit EUR
Base	2.000	85202130	FME	-



Overhead trolley B1 ME for Mammoth Electronic

Drive can be used in hanging position, shaft support available.

Description	Net weight [kg]	Item no.	Designation	Price/unit EUR
Overhead trolley	1.200	85202110	B1 ME	-



Overhead trolley B2 ME for Mammoth Electronic

Drive on castors can be used in hanging position.

Description	Net weight [kg]	Item no.	Designation	Price/unit EUR
Overhead trolley on castors	1.800	85202120	B2 ME	-





Drive systems with DIN 10/DIN 15

Flexible shaft drives for Mammoth Electronic and accessories



Trolley WA D ME for Mammoth Electronic

Trolley with tool tray, 4 steerable wheels of which 2 are lockable. Dimensions L x W x H: 500 x 500 x 510 mm.

Description	Net weight [kg]	Item no.	Designation	Price/unit EUR
Trolley	14.200	85202140	WA D ME	-



Shaft support WAL 4-12 for Mammoth Electronic

Support for flexible shaft that can be mounted onto the side of the drive.

Description	Net weight [kg]	Item no.	Designation	Price/unit EUR
Shaft support	0.460	85202150	WAL 4-12	-

Flexible shaft drives for Maxi-Mammoth Electronic and accessories



MME 40/150

Electronic flexible shaft drive with DIN 15 flexible shaft connection, generates very little noise and with 3-phase alternating current. High torque over the entire rotational speed range. Generates very little noise.

Contents:

4 m power cable without plug, 2 keys (STS D 6 mm).

- With smooth start-up to protect people, tools and the drive as well as a frequency inverter for maintaining a constant rotational speed.

Special features:

- Most powerful and stable torque with overload protection and stepless rotational speed control 100 to 15,000 RPM.
- Removable operating console with possibility of extension.

Rotational speed	Power consumption [watts]	Power output [watts]	Voltage [volts] 50–60 Hz	Net weight [kg]	Item no.	Designation	Price/unit EUR
15,000 – 100	6,100	4,000	340 – 480	36.160	85202060	MME 40/150 400 V	-



Remote control cable FSTK 40 for Maxi-Mammoth Electronic

For extending the removable operating console. With cover plate, to protect the motor.

Description	Net weight [kg]	Item no.	Designation	Price/unit EUR
Remote control cable	0.635	85202170	FSTK 40	-



Drive systems with DIN 10/DIN 15

Flexible shaft drives for Maxi-Mammoth Electronic and accessories



Foot switch FSE 22 for Maxi-Mammoth Electronic

For switching the drive on and off via the remote control interface.

Description	Net weight [kg]	Item no.	Designation	Price/unit EUR
Foot switch	1.000	85202105	FSE 22 2-POLIG	-

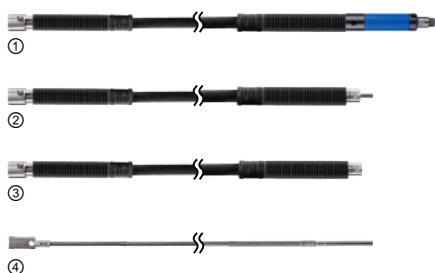


Trolley WA D ME for Maxi-Mammoth Electronic

Trolley with tool tray, 4 steerable wheels of which 2 are lockable. Dimensions L x W x H: 500 x 500 x 510 mm.

Description	Net weight [kg]	Item no.	Designation	Price/unit EUR
Trolley	14.200	85202140	WA D ME	-

Flexible shaft 4 and handpieces



Flexible shaft 4

With low power output requirements, it is possible to fall below the rotational speed range. The **radius of curvature must not be less than 100 mm**. After approximately 100 operating hours, the core of the flexible shaft must be re-lubricated.

Special features:

- Special lengths available on request.
- Cores and hoses with double-sided sliding coupling on request.

Image	Rotational speed range [RPM]	Drive-side coupling DIN / dia. [mm]	Handpiece-side coupling G / dia. [mm]	Dimensions dia. x length [mm]	Net weight [kg]	Item no.	Designation	Price/unit EUR
Flexible shaft inc. handpiece (HA 4 G16)								
(1)	40,000 – 18,000	10 / 30	16 / 16	13 x 1,400	0.630	86100505	BW 4 DIN10/G16	-
Flexible shaft without handpiece								
(2)	40,000 – 18,000	10 / 30	16 / 16	13 x 1,329	0.450	86200505	BW 4 DIN10/G16 oHA	-
Replacement casing								
(3)	-	10 / 30	16 / 16	13 x 1,300	0.330	86200605	SCH 4 DIN10/G16	-
Replacement core								
(4)	40,000 – 18,000	10 / M10	16 / 3,5/2,45	4 x 1,329	0.120	86200305	SE 4 DIN10/G16	-





Handpiece HA 4 G16

Much more ergonomic straight handpiece. Can be connected to all flexible shafts with G16 sliding coupling.

Contents:

1 collet 6 mm (collet group 6), 2 keys (1x EM SW 11 mm, 1x EM SW 12 mm).

Max. RPM	Handpiece-side coupling G / dia. [mm]	Dimensions dia. x length [mm]	Net weight [kg]	Item no.	Designation	Price/unit EUR
40,000	16 / 16	24 x 120	0.180	86200035	HA 4 G16	-



Angle handpiece WHA 4 90° G16

Much more ergonomic handpiece. Can be connected to all flexible shafts with G16 sliding coupling.

Contents:

1 collet 6 mm (collet group 6), 2 keys (1x EM SW 11 mm, 1x EM SW 14 mm).

Max. RPM	Handpiece-side coupling G / dia. [mm]	Dimensions dia. x length [mm]	Transmission ratio	Net weight [kg]	Item no.	Designation	Price/unit EUR
20,000	16 / 16	70 x 120	1,8:1	0.304	86300121	WHA 4 90° G16	-

Flexible shaft 6 and handpieces



Flexible shaft 6

With low power output requirements, it is possible to fall below the rotational speed range. The **radius of curvature must not be less than 140 mm**. After approximately 100 operating hours, the core of the flexible shaft must be re-lubricated.

Special features:

- Special lengths available on request.

Image	Rotational speed range [RPM]	Drive-side coupling DIN / dia. [mm]	Handpiece-side coupling G / dia. [mm]	Dimensions dia. x length [mm]	Net weight [kg]	Item no.	Designation	Price/unit EUR
Flexible shaft inc. handpiece (HA 4 G16)								
(1)	25,000 – 11,000	10 / 30	16 / 16	16 x 1,650	1.190	86210051	BW 6 DIN10/G16	-
Flexible shaft without handpiece								
(2)	25,000 – 11,000	10 / 30	16 / 16	16 x 1,583	1.100	86210060	BW 6 DIN10/G16 oHA	-
Replacement casing								
(3)	-	10 / 30	16 / 16	16 x 1,553	0.740	86210080	SCH 6 DIN10/G16	-
Replacement core								
(4)	25,000 – 11,000	10 / M10	16 / 3,5/2,45	6 x 1,583	0.270	86210070	SE 6 DIN10/G16	-



Drive systems with DIN 10/DIN 15

Flexible shaft 6 and handpieces



Handpiece HA 4 G16

Much more ergonomic straight handpiece. Can be connected to all flexible shafts with G16 sliding coupling.

Contents:

1 collet 6 mm (collet group 6), 2 keys (1x EM SW 11 mm, 1x EM SW 12 mm).

Max. RPM	Handpiece-side coupling G / dia. [mm]	Dimensions dia. x length [mm]	Net weight [kg]	Item no.	Designation	Price/unit EUR
40,000	16 / 16	24 x 120	0.180	86200035	HA 4 G16	-



Angle handpiece WHA 4 90° G16

Much more ergonomic handpiece. Can be connected to all flexible shafts with G16 sliding coupling.

Contents:

1 collet 6 mm (collet group 6), 2 keys (1x EM SW 11 mm, 1x EM SW 14 mm).

Max. RPM	Handpiece-side coupling G / dia. [mm]	Dimensions dia. x length [mm]	Transmission ratio	Net weight [kg]	Item no.	Designation	Price/unit EUR
20,000	16 / 16	70 x 120	1,8:1	0.304	86300121	WHA 4 90° G16	-

Flexible shaft 6 Z and handpieces



Flexible shaft 6 Z

With low power output requirements, it is possible to fall below the rotational speed range. The **radius of curvature must not be less than 140 mm**. After approximately 100 operating hours, the core of the flexible shaft must be re-lubricated.



Special features:

- Special lengths available on request.

Image	Rotational speed range [RPM]	Drive-side coupling DIN / dia. [mm]	Handpiece-side coupling G / dia. [mm]	Dimensions dia. x length [mm]	Net weight [kg]	Item no.	Designation	Price/unit EUR
Flexible shaft (without handpiece having duplex spring coupling DPF)								
(1)	18,000 – 9,000	10 / 30	DPF / 10	12 x 1,250	0.800	86210010	BW 6 Z DIN 10/DPF oHA	-
Flexible shaft (without handpiece having expansion ring coupling SRF)								
(2)	18,000 – 9,000	10 / 30	SRF / 10	12 x 1,250	0.800	86210020	BW 6 Z DIN 10/SRF oHA	-



Handpiece HA 6 Z DPF/SRF

Straight handpiece, can be connected to flexible shafts, with handpiece-side coupling DPF/ SRF (DPF = fixed duplex spring, SRF = flexible expansion ring).

Contents:

1 collet 6 mm (collet group 13), 2 keys (1x EM SW 9 mm, 1x STS D 2.5 mm).

Max. RPM	Handpiece-side coupling G / dia. [mm]	Dimensions dia. x length [mm]	Net weight [kg]	Item no.	Designation	Price/unit EUR
18,000	DPF/SRF / 10	24 x 140	0.131	86210100	HA 6 Z DPF/SRF	-



Handpiece HA 6 Z SP 3.0 DPF/SRF

Straight handpiece, can be connected to flexible shafts, with handpiece-side coupling DPF/SRF (DPF = fixed duplex spring, SRF = flexible expansion ring).

Contents:
1 collet SPZ 90187030 3 mm

Max. RPM	Handpiece-side coupling G / dia. [mm]	Dimensions dia. x length [mm]	Net weight [kg]	Item no.	Designation	Price/unit EUR
18,000	DPF/SRF / 10	22 x 139	0.109	86210110	HA 6 Z SP 3.0 DPF/SRF	-



Angle handpiece WZ 6 DPF/SRF

Handpiece, can be connected to flexible shafts, with handpiece-side coupling DPF/SRF (DPF = fixed duplex spring, SRF = flexible expansion ring).

Contents:
1 collet 6 mm (collet group 13), 2 keys (1x EM SW 9 mm, 1x SKS SW 4 mm).

Max. RPM	Handpiece-side coupling G / dia. [mm]	Dimensions dia. x length [mm]	Transmission ratio	Net weight [kg]	Item no.	Designation	Price/unit EUR
18,000	DPF/SRF / 10	50 x 170	1,25:1	0.225	86210120	WZ 6 DPF/SRF	-



Angle handpiece WZT 6 3.0 DPF/SRF

Handpiece with telescopic system, can be connected to flexible shafts, with handpiece-side coupling DPF/SRF (DPF = fixed duplex spring, SRF = flexible expansion ring).

Contents:
1 collet 3 mm (collet group 14), 2 keys (EM SW 7 mm).

Max. RPM	Handpiece-side coupling G / dia. [mm]	Dimensions dia. x length [mm]	Transmission ratio	Net weight [kg]	Item no.	Designation	Price/unit EUR
18,000	DPF/SRF / 10	35 x 170	1,38:1	0.170	86210130	WZT 6 3.0 DPF/SRF	-



Angle handpiece WZT 6 45° 6.0 DPF/SRF

Handpiece with telescopic system, can be connected to flexible shafts, with handpiece-side coupling DPF/SRF (DPF = fixed duplex spring, SRF = flexible expansion ring).

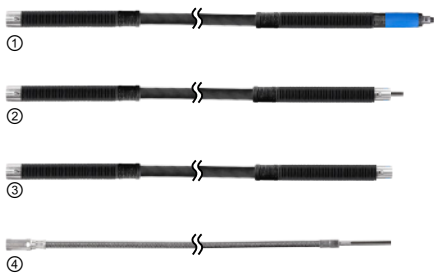
Contents:
1 collet 6 mm (collet group 13), 2 keys (1x EM SW 9 mm, 1x EM SW 14 mm).

Max. RPM	Handpiece-side coupling G / dia. [mm]	Dimensions dia. x length [mm]	Transmission ratio	Net weight [kg]	Item no.	Designation	Price/unit EUR
18,000	DPF/SRF / 10	45 x 200	1,53:1	0.210	86210140	WZT 6 45° 6.0 DPF/SRF	-



Drive systems with DIN 10/DIN 15

Flexible shaft 7 and handpieces



Flexible shaft 7

With low power output requirements, it is possible to fall below the rotational speed range. The **radius of curvature must not be less than 140 mm**. After approximately 100 operating hours, the core of the flexible shaft must be re-lubricated.

Special features:

- Special lengths available on request.
- Cores and hoses with double-sided sliding coupling on request.

Image	Rotational speed range [RPM]	Drive-side coupling DIN / dia. [mm]	Handpiece-side coupling G / dia. [mm]	Dimensions dia. x length [mm]	Net weight [kg]	Item no.	Designation	Price/unit EUR
Flexible shaft inc. handpiece (HA 7 G22)								
(1)	25,000 – 11,000	10 / 30	22 / 22	18 x 1,654	1.536	86100509	BW 7 DIN10/G22	-
				18 x 2,154	1.986	86100529	BW 7 DIN10/G22 2M	-
Flexible shaft without handpiece								
(2)	25,000 – 11,000	10 / 30	22 / 22	18 x 1,589	1.250	86200509	BW 7 DIN10/G22 oHA	-
				18 x 2,089	1.700	86200529	BW 7 DIN10/G22 2M oHA	-
Replacement casing								
(3)	-	10 / 30	22 / 22	18 x 1,553	0.850	86200609	SCH 7 DIN10/G22	-
				18 x 2,053	1.100	86200629	SCH 7 DIN10/G22 2M	-
Replacement core								
(4)	25,000 – 11,000	10 / M10	22 / 5/3,85	7 x 1,589	0.400	86200309	SE 7 DIN10/G22	-
				7 x 2,089	0.600	86200329	SE 7 DIN10/G22 2M	-



Handpiece HA 7 G22

Much more ergonomic straight handpiece. Can be connected to all flexible shafts with G22 sliding coupling.

Contents:

1 collet 6 mm (collet group 6), 2 keys (1x EM SW 11 mm, 1x EM SW 14 mm).

Max. RPM	Handpiece-side coupling G / dia. [mm]	Dimensions dia. x length [mm]	Net weight [kg]	Item no.	Designation	Price/unit EUR
25,000	22 / 22	30 x 130	0.286	86200036	HA 7 G22	-



Angle handpiece WHA 7 90° G22

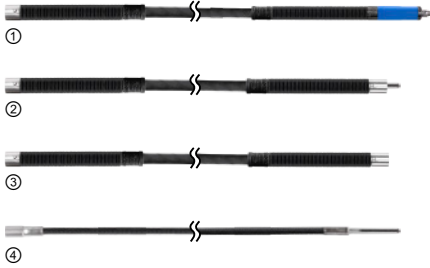
Much more ergonomic handpiece. Can be connected to all flexible shafts with G22 sliding coupling.

Contents:

1 collet 6 mm (collet group 6), 2 keys (1x EM SW 11 mm, 1x EM SW 14 mm).

Max. RPM	Handpiece-side coupling G / dia. [mm]	Dimensions dia. x length [mm]	Transmission ratio	Net weight [kg]	Item no.	Designation	Price/unit EUR
17,100	22 / 22	67 x 165	1:1	0.650	86300122	WHA 7 90° G22	-





Flexible shaft 10 SE 11

The rotational speed should not fall below or exceed the specified range. The **radius of curvature must not be less than 170 mm**. After approximately 100 operating hours, the core of the flexible shaft must be re-lubricated.

Special features:

- Special lengths available on request.
- Cores and hoses with double-sided sliding coupling on request.

Image	Rotational speed range [RPM]	Drive-side coupling DIN / dia. [mm]	Handpiece-side coupling G / dia. [mm]	Dimensions dia. x length [mm]	Net weight [kg]	Item no.	Designation	Price/unit EUR
Flexible shaft inc. handpiece (HA 10 G28)								
(1)	18,000 – 750	10 / 30	28 / 28	22 x 1,673	2.663	86101510	BW 10 SE 11 DIN10/G28	-
				22 x 2,173	3.113	86101511	BW 10 SE 11 DIN10/G28 2M	-
		15 / 40	28 / 28	22 x 1,684	2.713	86100714	BW 10 SE 11 DIN 15/G28	-
Flexible shaft without handpiece								
(2)	18,000 – 750	10 / 30	28 / 28	22 x 1,600	2.232	86200516	BW 10 SE 11 DIN10/G28 oHA	-
				22 x 2,100	2.682	86200517	BW 10 SE 11 DIN10/G28 2M oHA	-
		15 / 40	28 / 28	22 x 1,611	2.282	86200714	BW 10 SE 11 DIN 15/G28 oHA	-
Replacement casing								
(3)	-	10 / 30	28 / 28	22 x 1,553	1.430	86200630	SCH 10 DIN10/G28	-
				22 x 2,053	1.580	86200631	SCH 10 DIN10/G28 2M	-
		15 / 40	28 / 28	22 x 1,570	1.430	86200614	SCH 10 DIN 15/G28	-
Replacement core								
(4)	18,000 – 750	10 / M10	28 / 7,5/5,85	11 x 1,600	0.802	87100951	SE 11 DIN10/G28	-
				11 x 2,100	1.102	87100133	SE 11 DIN10/G28 2M	-
		15 / M14	28 / 7,5/5,85	11 x 1,611	0.852	86200314	SE 11 DIN 15/G28	-



Handpiece HA 10 G28

Much more ergonomic straight handpiece. Can be connected to all flexible shafts with G28 sliding coupling.

Contents:

1 collet 6 mm (collet group 6), 2 keys (1x EM SW 11 mm, 1x EM SW 15 mm).

Max. RPM	Handpiece-side coupling G / dia. [mm]	Dimensions dia. x length [mm]	Net weight [kg]	Item no.	Designation	Price/unit EUR
18,000	28 / 28	35 x 160	0.431	86200037	HA 10 G28	-



Handpiece HA 12 G28

Much more ergonomic straight handpiece. Can be connected to all flexible shafts with G28 sliding coupling. Available with clamping nut for maximum clamping force and collets up to 12 mm.

Contents:

1 collet 6 mm (collet group 12), 2 keys (DM SW 20/22 mm).

Max. RPM	Handpiece-side coupling G / dia. [mm]	Dimensions dia. x length [mm]	Net weight [kg]	Item no.	Designation	Price/unit EUR
18,000	28 / 28	35 x 170	0.545	86200038	HA 12 G28	-



Drive systems with DIN 10/DIN 15

Flexible shaft 10 and handpieces



Angle handpiece WHA 10 90° G28

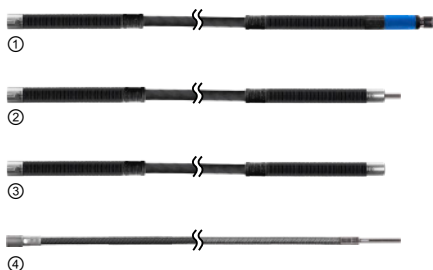
Much more ergonomic handpiece. Can be connected to all flexible shafts with G28 sliding coupling.

Contents:

1 collet 6 mm (collet group 6), 2 keys (1x EM SW 11 mm, 1x EM SW 14 mm).

Max. RPM	Handpiece-side coupling G / dia. [mm]	Dimensions dia. x length [mm]	Transmission ratio	Net weight [kg]	Item no.	Designation	Price/unit EUR
17,100	28 / 28	67 x 165	1:1	0.640	86300123	WHA 10 90° G28	-

Flexible shaft 12 and handpieces



Flexible shaft 12

The rotational speed should not fall below or exceed the specified range. The **radius of curvature must not be less than 240 mm**. After approximately 100 operating hours, the core of the flexible shaft must be re-lubricated.

Special features:

- Special lengths available on request.
- Cores and hoses with double-sided sliding coupling on request.

Image	Rotational speed range [RPM]	Drive-side coupling DIN / dia. [mm]	Handpiece-side coupling G / dia. [mm]	Dimensions dia. x length [mm]	Net weight [kg]	Item no.	Designation	Price/unit EUR
Flexible shaft inc. handpiece (HA 12 G28)								
(1)	12,000 – 850	10 / 30	28 / 28	25 x 2,173	4.295	86101512	BW 12 DIN10/G28	-
		15 / 40	28 / 28	25 x 2,183	4.345	86101513	BW 12 DIN15/G28	-
Flexible shaft without handpiece								
(2)	12,000 – 850	10 / 30	28 / 28	25 x 2,102	3.750	86200518	BW 12 DIN10/G28 oHA	-
		15 / 40	28 / 28	25 x 2,112	3.800	86200519	BW 12 DIN15/G28 oHA	-
Replacement casing								
(3)	-	10 / 30	28 / 28	25 x 2,045	2.450	86200633	SCH 12 DIN10/G28	-
		15 / 40	28 / 28	25 x 2,059	2.500	86200634	SCH 12 DIN15/G28	-
Replacement core								
(4)	12,000 – 850	10 / M10	28 / 7,5/5,85	12 x 2,102	1.300	86200333	SE 12 DIN10/G28	-
		15 / M14	28 / 7,5/5,85	12 x 2,112	1.300	86200334	SE 12 DIN15/G28	-



Handpiece HA 10 G28

Much more ergonomic straight handpiece. Can be connected to all flexible shafts with G28 sliding coupling.

Contents:

1 collet 6 mm (collet group 6), 2 keys (1x EM SW 11 mm, 1x EM SW 15 mm).

Max. RPM	Handpiece-side coupling G / dia. [mm]	Dimensions dia. x length [mm]	Net weight [kg]	Item no.	Designation	Price/unit EUR
18,000	28 / 28	35 x 160	0.431	86200037	HA 10 G28	-



Handpiece HA 12 G28

Much more ergonomic straight handpiece. Can be connected to all flexible shafts with G28 sliding coupling. Available with clamping nut for maximum clamping force and collets up to 12 mm.

Contents:

1 collet 6 mm (collet group 12), 2 keys (DM SW 20/22 mm).

Max. RPM	Handpiece-side coupling G / dia. [mm]	Dimensions dia. x length [mm]	Net weight [kg]	Item no.	Designation	Price/unit EUR
18,000	28 / 28	35 x 170	0.545	86200038	HA 12 G28	-



Angle handpiece WHA 10 90° G28

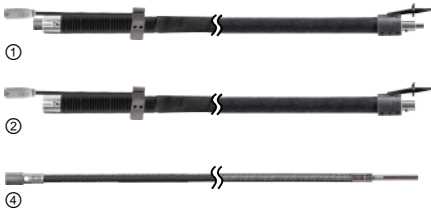
Much more ergonomic handpiece. Can be connected to all flexible shafts with G28 sliding coupling.

Contents:

1 collet 6 mm (collet group 6), 2 keys (1x EM SW 11 mm, 1x EM SW 14 mm).

Max. RPM	Handpiece-side coupling G / dia. [mm]	Dimensions dia. x length [mm]	Transmission ratio	Net weight [kg]	Item no.	Designation	Price/unit EUR
17,100	28 / 28	67 x 165	1:1	0.640	86300123	WHA 10 90° G28	-

Remote switch for flexible shafts and accessories



Remote switch for flexible shafts

Convenient operation from the workstation. Alternative to the foot switch. After approximately 100 operating hours, the core of the flexible shaft must be re-lubricated.

Special features:

- Switch on and off directly on the handpiece.
- Quick handpiece changing possible.

- Enhanced safety thanks to fast switch-off.

Image	Rotational speed range [RPM]	Drive-side coupling DIN / dia. [mm]	Handpiece-side coupling G / dia. [mm]	Dimensions dia. x length [mm]	Net weight [kg]	Item no.	Designation	Price/unit EUR
Flexible shaft 7								
(1)	25,000 – 11,000	10 / 30	22 / 22	18 x 2,089	2.000	86200657	FS-BW 7 DIN10/G22 2M oHA	-
(2)	-	10 / 30	22 / 22	18 x 2,053	1.400	86200658	FS-SCH 7 DIN10/G22 2M	-
(4)	25,000 – 11,000	10 / M10	22 / 5/3,85	7 x 2,089	0.600	86200329	SE 7 DIN10/G22 2M	-
Flexible shaft 10								
(1)	18,000 – 750	10 / 30	28 / 28	22 x 2,100	3.012	86200659	FS-BW 10 SE 11 DIN10/G28 2M oHA	-
(2)	-	10 / 30	28 / 28	22 x 2,053	1.910	86200660	FS-SCH 10 DIN10/G28 2M	-
(4)	18,000 – 750	10 / M10	28 / 7,5/5,85	11 x 2,100	1.102	87100133	SE 11 DIN10/G28 2M	-
Flexible shaft 12								
(1)	12,000 – 850	10 / 30	28 / 28	25 x 2,102	4.080	86200661	FS-BW 12 DIN10/G28 2M oHA	-
(2)	-	10 / 30	28 / 28	25 x 2,045	2.780	86200662	FS-SCH 12 DIN10/G28 2M	-
(4)	12,000 – 850	10 / M10	28 / 7,5/5,85	12 x 2,102	1.300	86200333	SE 12 DIN10/G28	-



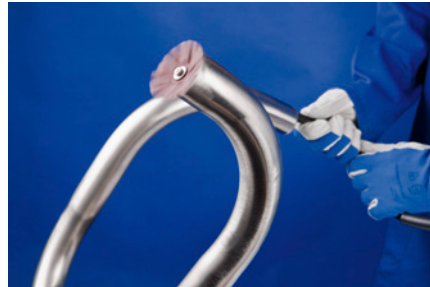
Drive systems with DIN 10/DIN 15

Special flexible shafts for inner grinding of pipes and accessories



Flexible shaft 4 PST-T | Flexible shaft 7 PST-T

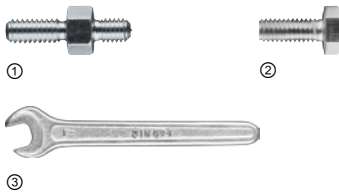
The POLISTAR-TUBE grinding tools are attached directly to the core of the special flexible shaft. After approximately 100 operating hours, the core of the flexible shaft must be re-lubricated.



Special features:

- Excellent for gradual fine grinding and cleaning of inner surfaces of pipes and pipe bends.
- Both pipe bend ends can be deburred from the entry side.
- The special flexible shafts do not have a handpiece for tool mounting and are particularly flexible in the front section.

Image	Rotational speed range [RPM]	Drive-side coupling DIN / dia. [mm]	Dimensions dia. x length [mm]	Fastening thread	Tool mounting [mm]	Net weight [kg]	Item no.	Designation	Price/unit EUR
Flexible shaft									
(1)	7,650 – 1,500	10 / 30	13 x 1,537	M4	4	0.480	87101801	BW 4 PST-T DIN 10/M4 1,5 m	-
	4,250 – 1,500	10 / 30	18 x 2,032	M5	5	1.320	87101804	BW 7 PST-T DIN 10/M5 2 m	-
Pre-assembled replacement casing									
(2)	-	10 / 30	13 x 1,537	-	-	0.353	87101803	SCH 4 PST-T DIN 10/M4 1.5 m	-
			18 x 2,032	-	-	0.871	87101806	SCH 7 PST-T DIN 10/M5 2 m	-
Pre-assembled replacement core									
(3)	7,650 – 1,500	10 / M10	4 x 1,528	M4	4	0.124	87101802	SE 4 PST-T DIN10/M4 1,5 m	-
	4,250 – 1,500	10 / M10	7 x 2,031	M5	5	0.447	87101805	SE 7 PST-T DIN 10/M5 2 m	-



Accessories for flexible shafts BW 4 PST-T, 7 PST-T

PFERD offers thread adapters, flange screws and keys.

Image	Tool mounting [mm]	Net weight [kg]	Item no.	Designation	Price/unit EUR
Suitable for BW 4 PST-T					
(1)	8-32 UNC	0.002	87101500	AD M4/8-32 UNC	-
(2)	4	0.002	87200221	FLS M4	-
(3)	-	0.008	90001914	EM SW 7 mm	-
Suitable for BW 7 PST-T					
(1)	8-32 UNC	0.003	87101501	AD M5/8-32 UNC	-
(2)	5	0.003	87200222	FLS M5	-
(3)	-	0.014	93785706	EM SW 8 mm G	-





Handpiece HA 4 G16

Much more ergonomic straight handpiece. Can be connected to all flexible shafts with G16 sliding coupling.

Contents:

1 collet 6 mm (collet group 6), 2 keys (1x EM SW 11 mm, 1x EM SW 12 mm).

Max. RPM	Handpiece-side coupling G / dia. [mm]	Dimensions dia. x length [mm]	Net weight [kg]	Item no.	Designation	Price/unit EUR
40,000	16 / 16	24 x 120	0.180	86200035	HA 4 G16	-



Handpiece HA 7 G22

Much more ergonomic straight handpiece. Can be connected to all flexible shafts with G22 sliding coupling.

Contents:

1 collet 6 mm (collet group 6), 2 keys (1x EM SW 11 mm, 1x EM SW 14 mm).

Max. RPM	Handpiece-side coupling G / dia. [mm]	Dimensions dia. x length [mm]	Net weight [kg]	Item no.	Designation	Price/unit EUR
25,000	22 / 22	30 x 130	0.286	86200036	HA 7 G22	-



Handpiece HA 10 G28

Much more ergonomic straight handpiece. Can be connected to all flexible shafts with G28 sliding coupling.

Contents:

1 collet 6 mm (collet group 6), 2 keys (1x EM SW 11 mm, 1x EM SW 15 mm).

Max. RPM	Handpiece-side coupling G / dia. [mm]	Dimensions dia. x length [mm]	Net weight [kg]	Item no.	Designation	Price/unit EUR
18,000	28 / 28	35 x 160	0.431	86200037	HA 10 G28	-



Handpiece HA 12 G28

Much more ergonomic straight handpiece. Can be connected to all flexible shafts with G28 sliding coupling. Available with clamping nut for maximum clamping force and collets up to 12 mm.

Contents:

1 collet 6 mm (collet group 12), 2 keys (DM SW 20/22 mm).

Max. RPM	Handpiece-side coupling G / dia. [mm]	Dimensions dia. x length [mm]	Net weight [kg]	Item no.	Designation	Price/unit EUR
18,000	28 / 28	35 x 170	0.545	86200038	HA 12 G28	-





Angle handpiece WHA 4 90° G16

Much more ergonomic handpiece. Can be connected to all flexible shafts with G16 sliding coupling.

Contents:

1 collet 6 mm (collet group 6), 2 keys (1x EM SW 11 mm, 1x EM SW 14 mm).

Max. RPM	Handpiece-side coupling G / dia. [mm]	Dimensions dia. x length [mm]	Transmission ratio	Net weight [kg]	Item no.	Designation	Price/unit EUR
20,000	16 / 16	70 x 120	1,8:1	0.304	86300121	WHA 4 90° G16	-



Angle handpiece WHA 7 90° G22

Much more ergonomic handpiece. Can be connected to all flexible shafts with G22 sliding coupling.

Contents:

1 collet 6 mm (collet group 6), 2 keys (1x EM SW 11 mm, 1x EM SW 14 mm).

Max. RPM	Handpiece-side coupling G / dia. [mm]	Dimensions dia. x length [mm]	Transmission ratio	Net weight [kg]	Item no.	Designation	Price/unit EUR
17,100	22 / 22	67 x 165	1:1	0.650	86300122	WHA 7 90° G22	-



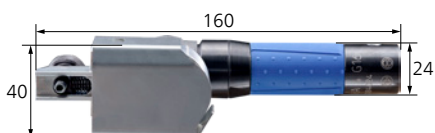
Angle handpiece WHA 10 90° G28

Much more ergonomic handpiece. Can be connected to all flexible shafts with G28 sliding coupling.

Contents:

1 collet 6 mm (collet group 6), 2 keys (1x EM SW 11 mm, 1x EM SW 14 mm).

Max. RPM	Handpiece-side coupling G / dia. [mm]	Dimensions dia. x length [mm]	Transmission ratio	Net weight [kg]	Item no.	Designation	Price/unit EUR
17,100	28 / 28	67 x 165	1:1	0.640	86300123	WHA 10 90° G28	-



Belt grinder handpiece BHA 4 G16 oVA

Belt grinder handpiece with belt grinder attachment and G16 sliding coupling. Belt grinder attachment without attachment arm. Suitable for belt grinder attachment arms from belt grinder attachment arm group 1.



Contents:

1 key (SKS SW 4 mm), 1x protective cover.

Special features:

- The belt grinder attachment can be pivoted on the drive system.

Max. RPM	Handpiece-side coupling G / dia. [mm]	Transmission ratio	Net weight [kg]	Item no.	Designation	Price/unit EUR
20,000	16 / -	1,8:1	0.403	86400001	BHA 4 G16 oVA	-



Belt grinder handpiece BHA 7 G22 oVA

Belt grinder handpiece with belt grinder attachment and G22/diameter 22 mm sliding coupling. Belt grinder attachment without attachment arm. Suitable for belt grinder attachment arms from belt grinder attachment arm group 2.

Contents:

2 keys (1x SKS SW 2.5 mm and 1x SKS SW 4 mm), 1 protective cover

Special features:

- The belt grinder attachment can be pivoted on the drive system.
- The BSAD 41/36 x 610 belt grinding adapter achieves a belt length of 610 mm.

Max. RPM	Handpiece-side coupling G / dia. [mm]	Transmission ratio	Net weight [kg]	Item no.	Designation	Price/unit EUR
17,100	22 / -	1:1	0.766	86400002	BHA 7 G22 oVA	-



Belt grinder handpiece BHA 10 G28 oVA

Belt grinder handpiece with belt grinder attachment and G28/diameter 28 mm sliding coupling. Belt grinder attachment without attachment arm. Suitable for belt grinder attachment arms from belt grinder attachment arm group 2.

Contents:

2 keys (1x SKS SW 2.5 mm and 1x SKS SW 4 mm), 1 protective cover

Special features:

- The belt grinder attachment can be pivoted on the drive system.
- The BSAD 41/36 x 610 belt grinding adapter achieves a belt length of 610 mm.

Max. RPM	Handpiece-side coupling G / dia. [mm]	Transmission ratio	Net weight [kg]	Item no.	Designation	Price/unit EUR
17,100	28 / -	1:1	0.766	86400004	BHA 10 G28 oVA	-



Handpiece HA 6 Z DPF/SRF

Straight handpiece, can be connected to flexible shafts, with handpiece-side coupling DPF/ SRF (DPF = fixed duplex spring, SRF = flexible expansion ring).

Contents:

1 collet 6 mm (collet group 13), 2 keys (1x EM SW 9 mm, 1x STS D 2.5 mm).

Max. RPM	Handpiece-side coupling G / dia. [mm]	Dimensions dia. x length [mm]	Net weight [kg]	Item no.	Designation	Price/unit EUR
18,000	DPF/SRF / 10	24 x 140	0.131	86210100	HA 6 Z DPF/SRF	-





Handpiece HA 6 Z SP 3.0 DPF/SRF

Straight handpiece, can be connected to flexible shafts, with handpiece-side coupling DPF/SRF (DPF = fixed duplex spring, SRF = flexible expansion ring).

Contents:
1 collet SPZ 90187030 3 mm

Max. RPM	Handpiece-side coupling G / dia. [mm]	Dimensions dia. x length [mm]	Net weight [kg]	Item no.	Designation	Price/unit EUR
18,000	DPF/SRF / 10	22 x 139	0.109	86210110	HA 6 Z SP 3.0 DPF/SRF	-



Angle handpiece WZ 6 DPF/SRF

Handpiece, can be connected to flexible shafts, with handpiece-side coupling DPF/SRF (DPF = fixed duplex spring, SRF = flexible expansion ring).

Contents:
1 collet 6 mm (collet group 13), 2 keys (1x EM SW 9 mm, 1x SKS SW 4 mm).

Max. RPM	Handpiece-side coupling G / dia. [mm]	Dimensions dia. x length [mm]	Transmission ratio	Net weight [kg]	Item no.	Designation	Price/unit EUR
18,000	DPF/SRF / 10	50 x 170	1,25:1	0.225	86210120	WZ 6 DPF/SRF	-



Angle handpiece WZT 6 3.0 DPF/SRF

Handpiece with telescopic system, can be connected to flexible shafts, with handpiece-side coupling DPF/SRF (DPF = fixed duplex spring, SRF = flexible expansion ring).

Contents:
1 collet 3 mm (collet group 14), 2 keys (EM SW 7 mm).

Max. RPM	Handpiece-side coupling G / dia. [mm]	Dimensions dia. x length [mm]	Transmission ratio	Net weight [kg]	Item no.	Designation	Price/unit EUR
18,000	DPF/SRF / 10	35 x 170	1,38:1	0.170	86210130	WZT 6 3.0 DPF/SRF	-



Angle handpiece WZT 6 45° 6.0 DPF/SRF

Handpiece with telescopic system, can be connected to flexible shafts, with handpiece-side coupling DPF/SRF (DPF = fixed duplex spring, SRF = flexible expansion ring).

Contents:
1 collet 6 mm (collet group 13), 2 keys (1x EM SW 9 mm, 1x EM SW 14 mm).

Max. RPM	Handpiece-side coupling G / dia. [mm]	Dimensions dia. x length [mm]	Transmission ratio	Net weight [kg]	Item no.	Designation	Price/unit EUR
18,000	DPF/SRF / 10	45 x 200	1,53:1	0.210	86210140	WZT 6 45° 6.0 DPF/SRF	-





Angle drive WT 10 G28

Can be connected to all flexible shafts with G28 connection (instead of the handpiece). Connection to flexible shaft can be pivoted 360°. With M14 spindle thread and 22.23 mm tool mounting.

Contents:

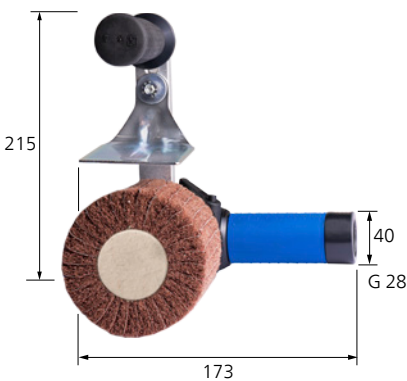
1 clamping nut (item no. 98980036), 2 flange screws (1x item no. 98980037, 1x item no. 98980038), 2 spacer sleeves (1x item no. 98980039, 1x item no. 98980040), 2 keys (1x STL SW 35 x 5 mm, 1x SKS SW

4 mm), guard dia. 125 mm, anti-vibration handle.

Special features:

- Enables flexible shaft drives to be used as angle grinders.

Drive operating speed n max. [RPM]	Transmission ratio	Output speed at n max. [RPM]	Net weight [kg]	Item no.	Designation	Price/unit EUR
18,000	1,53:1	12,000	1.438	86300621	WT 10 G28	-



Burnishing angle drive SWT 10 G28

Can be connected to all flexible shafts with G28 connection (instead of the handpiece). Connection to flexible shaft can be pivoted 360°. With M14 spindle thread and **tool mounting dia. x width 19 x 100 mm.**

Contents:

Hand guard, anti-vibration handle, detachable drive spindle.

Special features:

- Enables flexible shaft drives to be used as burnishing machines.

Drive operating speed n max. [RPM]	Transmission ratio	Output speed at n max. [RPM]	Net weight [kg]	Item no.	Designation	Price/unit EUR
18,000	1,53:1	12,000	1.901	87101531	SWT 10 G28	-



Drive systems with DIN 10/DIN 15

Belt sanders



BSG 10/35 E G28

Belt sander with a belt length of 450 mm x width 35 mm. Matching belts: BA 35/450 and VB 35/450. Can be connected to all flexible shafts with G28 sliding coupling (instead of the handpiece).

Contents:

1 key (SKST SW 17 mm).

Special features:

- Elastically mounted spindle.
- Can be connected to flexible shafts without handpiece.

Max. RPM	Matches handpiece-side flexible shaft coupling G/dia. [mm]	Net weight [kg]	Item no.	Designation	Price/unit EUR
7,000	28 / 28	1.500	86400160	BSG 10/35 E G28	-



BSG 10/50 E G28

Belt sander with a belt length of 450 mm x width 50 mm. Matching belts: BA 50/450 and VB 50/450. Can be connected to all flexible shafts with G28 sliding coupling (instead of the handpiece).

Contents:

1 key (SKST SW 17 mm).

Special features:

- Elastically mounted spindle.
- Can be connected to flexible shafts without handpiece.

Max. RPM	Matches handpiece-side flexible shaft coupling G/dia. [mm]	Net weight [kg]	Item no.	Designation	Price/unit EUR
7,000	28 / 28	1.580	86400156	BSG 10/50 E G28	-

Replacement rollers for belt sanders

PFERD offers guide rollers, drive rollers and soft drive rollers.



Image	Description	D [mm]	T [mm]	Suitable for belt sanders	Net weight [kg]	Item no.	Designation	Price/unit EUR
(2)	Guide roller	50	30	BSG 10/35 E G28	0.125	86400161	ULR BSG 10/35 E	-
(1)	Drive roller	100	30	BSG 10/35 E G28	0.250	86400162	ATR BSG 10/35 E	-
	Drive roller, soft	100	30	BSG 10/35 E G28	0.250	86400170	ATR-W BSG 10/35 E	-
(2)	Guide roller	50	40	BSG 10/50 E G28	0.145	86400157	ULR BSG 10/50 E	-
(1)	Drive roller	100	40	BSG 10/50 E G28	0.300	86400146	ATR BSG 10/50 E	-
	Drive roller, soft	100	40	BSG 10/50 E G28	0.300	86400171	ATR-W BSG 10/50 E	-



Handpiece HA 4 G16/G22 STV for rigid extensions

When combined with air-power and steplessly speed-adjustable electric motors, the ideal solution for applications in hard-to-access workpieces, e.g. during cleaning or milling work. Can be adapted to the workpiece geometry.

Contents:

1 collet 6 mm (collet group 6), 2 keys (1x EM SW 11 mm, 1x EM SW 12 mm).

Special features:

- Much more ergonomic handpiece. Can be connected to all flexible shafts with G16/G22 sliding coupling.

Max. RPM	Handpiece-side coupling G / dia. [mm]	Dimensions dia. x length [mm]	Collet group	Net weight [kg]	Item no.	Designation	Price/unit EUR
25,000	16 / 22	20 x 120	6	0.135	86200039	HA 4 G16/G22 STV	-



Handpiece HA 7 G22 STV for rigid extensions

When combined with air-power and steplessly speed-adjustable electric motors, the ideal solution for applications in hard-to-access workpieces, e.g. during cleaning or milling work. Can be adapted to the workpiece geometry.

Contents:

1 collet 1/4" (collet group 6), 2 keys (1x EM SW 11 mm, 1x EM SW 14 mm).

Special features:

- Much more ergonomic handpiece. Can be connected to all flexible shafts with G22 sliding coupling.

Max. RPM	Handpiece-side coupling G / dia. [mm]	Dimensions dia. x length [mm]	Collet group	Net weight [kg]	Item no.	Designation	Price/unit EUR
25,000	22 / 22	27 x 130	6	0.259	86200040	HA 7 G22 STV	-



Handpiece HA 10 G28 STV for rigid extensions

When combined with air-power and steplessly speed-adjustable electric motors, the ideal solution for applications in hard-to-access workpieces, e.g. during cleaning or milling work. Can be adapted to the workpiece geometry.

Contents:

1 collet 6 mm (collet group 6), 2 keys (1x EM SW 11 mm, 1x EM SW 15 mm).

Special features:

- Much more ergonomic handpiece. Can be connected to all flexible shafts with G28 sliding coupling.

Max. RPM	Handpiece-side coupling G / dia. [mm]	Dimensions dia. x length [mm]	Collet group	Net weight [kg]	Item no.	Designation	Price/unit EUR
18,000	28 / 28	33 x 160	6	0.396	86200041	HA 10 G28 STV	-



Handpiece HA 12 G28 STV for rigid extensions

When combined with air-power and steplessly speed-adjustable electric motors, the ideal solution for applications in hard-to-access workpieces, e.g. during cleaning or milling work. Can be adapted to the workpiece geometry.

Contents:

1 collet 6 mm (collet group 12), 2 keys (DM SW 20/22 mm).

Special features:

- Much more ergonomic handpiece. Can be connected to all flexible shafts with G28 sliding coupling.

Max. RPM	Handpiece-side coupling G / dia. [mm]	Dimensions dia. x length [mm]	Collet group	Net weight [kg]	Item no.	Designation	Price/unit EUR
18,000	28 / 28	33 x 170	12	0.512	86200042	HA 12 G28 STV	-



Drive systems with DIN 10/DIN 15

Handpieces for rigid extensions



Angle handpiece WHA 7 90° G22 STV for rigid extensions

When combined with air-power and steplessly speed-adjustable electric motors, the ideal solution for applications in hard-to-access workpieces, e.g. during cleaning or milling work. Can be adapted to the workpiece geometry.

Contents:

1 collet 1/4" (collet group 6), 2 keys (1x EM SW 11 mm, 1x EM SW 14 mm).

Special features:

- Much more ergonomic handpiece. Can be connected to all flexible shafts with G22 sliding coupling.

Max. RPM	Handpiece-side coupling G / dia. [mm]	Dimensions dia. x length [mm]	Transmission ratio	Collet group	Net weight [kg]	Item no.	Designation	Price/unit EUR
17,100	22 / 22	67 x 165	1:1	6	0.520	86300131	WHA 7 90° G22 STV	-



Angle handpiece WHA 10 90° G28 STV for rigid extensions

When combined with air-power and steplessly speed-adjustable electric motors, the ideal solution for applications in hard-to-access workpieces, e.g. during cleaning or milling work. Can be adapted to the workpiece geometry.

Contents:

1 collet 1/4" (collet group 6), 2 keys (1x EM SW 11 mm, 1x EM SW 14 mm).

Special features:

- Much more ergonomic handpiece. Can be connected to all flexible shafts with G28 sliding coupling.

Max. RPM	Handpiece-side coupling G / dia. [mm]	Dimensions dia. x length [mm]	Transmission ratio	Collet group	Net weight [kg]	Item no.	Designation	Price/unit EUR
17,100	28 / 28	67 x 165	1:1	6	0.579	86300132	WHA 10 90° G28 STV	-

Rigid extensions STV



Rigid extension STV9 DIN 10

Rigid extension with max. 25,000 RPM for hard-to-reach areas. No risk of overloading the drive motor when used in conjunction with DL motor.

Contents:

1 collet 3 mm (collet group 2), 3 keys (2x DM SW 6/7 mm, 1x SKS 4 mm).

Special features:

- Special lengths and options for workpiece adaptation available on request.

- The potential bending point and the bending radius depend on the STV type and the desired bend.
- Curved types available as from a minimum length of 500 mm.

Dimensions dia. x length [mm]	max. bending radius [mm]	Net weight [kg]	Item no.	Designation	Price/unit EUR
9 x 300	150	0.430	80900330	STV9 L300	-
9 x 500	150	0.520	80900335	STV9 L500	-
9 x 800	150	0.640	80900340	STV9 L800	-
9 x 1,000	150	0.720	80900345	STV9 L1000	-





Rigid extension STV13 DIN 10

Rigid extension with max. 25,000 RPM for hard-to-reach areas. No risk of overloading the drive motor when used in conjunction with DL motor.



Contents:

1 collet 6 mm (collet group 10), 3 keys (2x DM SW 9/11 mm, 1x SKS 4 mm).

Special features:

- Special lengths and options for workpiece adaptation available on request.
- The potential bending point and the bending radius depend on the STV type and the desired bend.
- Curved types available as from a minimum length of 500 mm.

Dimensions dia. x length [mm]	max. bending radius [mm]	Net weight [kg]	Item no.	Designation	Price/unit EUR
13 x 300	150	0.520	80900218	STV13 L300	-
13 x 500	150	0.670	80900232	STV13 L500	-
13 x 800	150	0.890	80900305	STV13 L800	-
13 x 1,000	150	1.040	80900310	STV13 L1000	-



Rigid extension STV20 DIN 10

Rigid extension for hard-to-reach areas. No risk of overloading the drive motor when used in conjunction with DL motor.

Contents:

1 collet 6 mm (collet group 6), 2 keys (1x EM SW 11 mm, 1x EM SW 12 mm), handpiece HA 4 G16/G22 STV.

Special features:

- Special lengths and options for workpiece adaptation available on request.

- The potential bending point and the bending radius depend on the STV type and the desired bend.
- Curved types available as from a minimum length of 500 mm.

Sliding coupling [G]	Dimensions dia. x length [mm]	max. bending radius [mm]	Matching handpiece	Net weight [kg]	Item no.	Designation	Price/unit EUR
16/22	20 x 200	-	HA 4 G16/G22 STV	0.400	80900351	STV20 L 200	-
	20 x 400	-	HA 4 G16/G22 STV	0.630	80900352	STV20 L 400	-
	20 x 600	150	HA 4 G16/G22 STV	0.890	80900353	STV20 L 600	-



Rigid extension STV27 DIN 10

Rigid extension for hard-to-reach areas. No risk of overloading the drive motor when used in conjunction with DL motor.

Special features:

- Special lengths and options for workpiece adaptation available on request.

- The potential bending point and the bending radius depend on the STV type and the desired bend.
- Curved types available as from a minimum length of 500 mm.

Sliding coupling [G]	Dimensions dia. x length [mm]	max. bending radius [mm]	Matching handpiece	Net weight [kg]	Item no.	Designation	Price/unit EUR
22	27 x 250	-	HA 7 G22 STV, WHA 7 G22 STV	0.550	80900354	STV27 L 250	-
	27 x 500	250	HA 7 G22 STV, WHA 7 G22 STV	0.930	80900355	STV27 L 500	-



Drive systems with DIN 10/DIN 15

Rigid extensions STV



Rigid extension STV33 DIN 10

Rigid extension for hard-to-reach areas. No risk of overloading the drive motor when used in conjunction with DL motor.

Special features:

- Special lengths and options for workpiece adaptation available on request.
- The potential bending point and the bending radius depend on the STV type and the desired bend.
- Curved types available as from a minimum length of 500 mm.

Sliding coupling [G]	Dimensions dia. x length [mm]	max. bending radius [mm]	Matching handpiece	Net weight [kg]	Item no.	Designation	Price/unit EUR
28	33 x 250	-	HA 10 G28 STV, HA 12 G28 STV, WHA 10 G28 STV	1.025	80900356	STV33 L 250	-
	33 x 500	300	HA 10 G28 STV, HA 12 G28 STV, WHA 10 G28 STV	2.100	80900357	STV33 L 500	-
	33 x 1,000	300	HA 10 G28 STV, HA 12 G28 STV, WHA 10 G28 STV	3.250	80900358	STV33 L 1000	-



Direct connection DA DIN 10

For direct (rigid) connection of handpieces with the sliding coupling (G) to flexible shaft drive motors with DIN 10 connection. Can be used as shortest rigid extension.

Sliding coupling [G]	Dimensions dia. x length [mm]	Matching handpiece	Net weight [kg]	Item no.	Designation	Price/unit EUR
22	30 x 90	HA 7 G22 STV, WHA 7 G22 STV	0.204	87100623	DA 27 DIN10/G22	-
28	30 x 100	HA 10 G28 STV, HA 12 G28 STV, WHA 10 G28 STV	0.305	80900029	DA 33 DIN10/G28	-



Replacement core DIN 10

Pre-assembled replacement core for the direct connection (DA).

Sliding coupling [G]	Dimensions dia. x length [mm]	Net weight [kg]	Item no.	Designation	Price/unit EUR
22	7 x 125	0.035	80900244	SE DA 27 DIN10/G22	-
28	12 x 153	0.107	80900088	SE DA 33 DIN10/G28	-

Flexible shaft adapter



①



②

Flexible shaft adapter

The flexible shaft adapter conveniently connects rigid extensions and flexible shafts.

Image	Net weight [kg]	Item no.	Designation	Price/unit EUR
(1)	0.285	86300307	BWA G22/DIN 10	-
(2)	0.563	86300308	BWA G28/DIN10	-



PMA 4/220 HV

Air-power motor with exhaust directed to the rear and dead man's switch using safety lever valve for rigid extensions with DIN 10 motor connection.

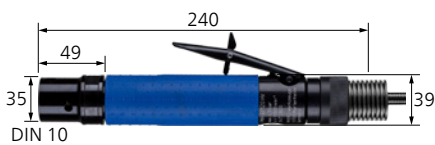
Contents:

1 m exhaust hose and 2.5 m air supply hose with 1/4" male threaded connection, threaded quick coupling (STGI), 2 keys (STS D 4 mm).

Special features:

- Very powerful with a compact design.
- Operate the drive with oil to achieve a high rotational speed and long service life.

RPM	Power output [watts]	Air consumption at idle [m ³ /min]	Air consumption under load [m ³ /min]	Connection coupling [DIN]	Air supply hose internal dia. [mm]	Net weight [kg]	Item no.	Designation	Price/unit EUR
22,000	440	0.98	0.87	10	8	0.913	80703306	PMA 4/220 HV	-



PMA 4/120 HV

Air-power motor with exhaust directed to the rear and dead man's switch using safety lever valve for rigid extensions with DIN 10 motor connection. With constant power delivery due to the centrifugal governor.

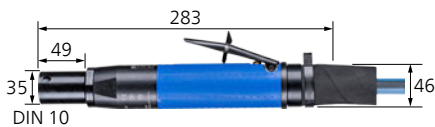
Contents:

1 m exhaust hose and 2.5 m air supply hose with 1/4" male threaded connection, threaded quick coupling (STGI), 2 keys (STS D 4 mm).

Special features:

- Very powerful with a compact design.
- Operate the drive with oil to achieve a high rotational speed and long service life.

RPM	Power output [watts]	Air consumption at idle [m ³ /min]	Air consumption under load [m ³ /min]	Connection coupling [DIN]	Air supply hose internal dia. [mm]	Net weight [kg]	Item no.	Designation	Price/unit EUR
12,000	370	0.5	0.87	10	8	0.995	80703307	PMA 4/120 HV	-



PMA 10/200 HV

Powerful air-power motor with exhaust directed to the rear and dead man's switch using safety lever valve for rigid extensions with motor connection DIN 10.

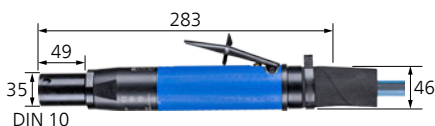
Contents:

1 m exhaust hose and 2.5 m air supply hose with 1/2" male threaded connection, 2 keys (STS D 4 mm).

Special features:

- The highest rotational speed in this power range.

RPM	Power output [watts]	Air consumption at idle [m ³ /min]	Air consumption under load [m ³ /min]	Connection coupling [DIN]	Air supply hose internal dia. [mm]	Net weight [kg]	Item no.	Designation	Price/unit EUR
20,000	1,000	1.38	1.1	10	13	1.200	80703135	PMA 10/200 HV	-



PMA 10/160 HV

Powerful air-power motor with exhaust directed to the rear and dead man's switch using safety lever valve for rigid extensions with motor connection DIN 10.

Contents:

1 m exhaust hose and 2.5 m air supply hose with 1/2" male threaded connection, 2 keys (STS D 4 mm).

Special features:

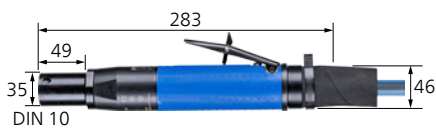
- With constant power delivery due to the centrifugal governor.

RPM	Power output [watts]	Air consumption at idle [m ³ /min]	Air consumption under load [m ³ /min]	Connection coupling [DIN]	Air supply hose internal dia. [mm]	Net weight [kg]	Item no.	Designation	Price/unit EUR
16,000	1,000	0.7	0.9	10	13	1.200	80703140	PMA 10/160 HV	-



Drive systems with DIN 10/DIN 15

DL motors DIN 10 for rigid extensions



PMA 10/120 HV

Powerful air-power motor with exhaust directed to the rear and dead man's switch using safety lever valve for rigid extensions with motor connection DIN 10.

Contents:

1 m exhaust hose and 2.5 m air supply hose with 1/2" male threaded connection, 2 keys (STS D 4 mm).

Special features:

- With constant power delivery due to the centrifugal governor.

RPM	Power output [watts]	Air consumption at idle [m ³ /min]	Air consumption under load [m ³ /min]	Connection coupling [DIN]	Air supply hose internal dia. [mm]	Net weight [kg]	Item no.	Designation	Price/unit EUR
12,000	950	0.5	0.9	10	13	1.200	80703150	PMA 10/120 HV	-

EL motors DIN 10 for rigid extensions



EMER 8/280

Electric motor for rigid extensions with DIN 10 motor connection. With stepless rotational speed control and digital electronics for constant rotational speed.

Contents:

4 m power cable, 2 keys (STS D 4 mm).

Special features:

- Overload protection.
- Smooth start-up to protect people, tools and the drive.

Rotational speed [RPM]	Power consumption [watts]	Power output [watts]	Voltage [volts] 50–60 Hz	Connection [DIN]	Net weight [kg]	Item no.	Designation	Price/unit EUR
28,000 – 8,500	750	410	230	10	2.030	83700330	EMER 8/280	-



EMER 8/90

Electric motor for rigid extensions with DIN 10 motor connection. With stepless rotational speed control and digital electronics for constant rotational speed.

Contents:

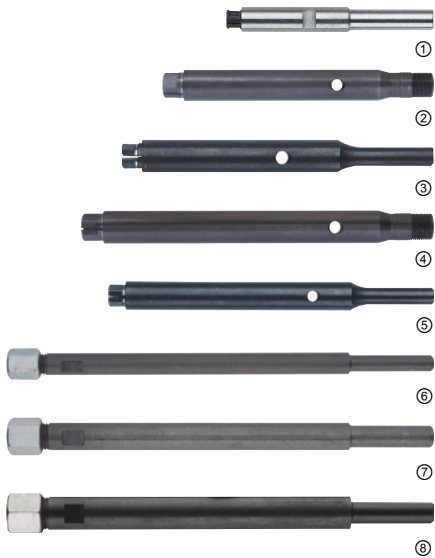
4 m power cable, 2 keys (STS D 4 mm).

Special features:

- Overload protection.
- Smooth start-up to protect people, tools and the drive.

Rotational speed [RPM]	Power consumption [watts]	Power output [watts]	Voltage [volts] 50–60 Hz	Connection [DIN]	Net weight [kg]	Item no.	Designation	Price/unit EUR
9,000 – 2,500	710	410	230	10	2.030	83700340	EMER 8/90	-





Extensions for drive spindles, metric version

Allow access to difficult-to-reach areas and are clamped into the collet of the machine (air or electric grinder) or into the flexible shaft handpiece.

Special features:

- Cost-effective alternative to customized burrs and mounted points with long shanks.

Image	Max. RPM	Shank mounting dia. S [mm]	Tool mounting [mm]	Total length L ₁ [mm]	Mounting pin length L ₂ [mm]	Max. spindle dia. D [mm]	Incl. collet dia. [mm]	Collet group	Net weight [kg]	Item no.	Designation	Price/unit EUR
(1)	44,000	6	3	76	30	9.5	3	14	0.028	87100359	SPV 50-3 S6	-
		8	3	78	30	9.5	3	14	0.035	87100356	SPV 50-3 S8	-
(2)	20,000	SPG6	6	104	Special	12	6	10	0.073	87100728	SPV 75-6 SPG6	-
(3)	20,000	6	6	58	18	12	6	10	0.025	87100069	SPV 36-6 S6	-
				95	30	12	6	10	0.055	87100365	SPV 50-6 S8	-
				120	30	12	6	10	0.076	87100358	SPV 75-6 S8	-
(4)	20,000	SPG6	6	129	Special	12	6	10	0.096	87101237	SPV 100-6 SPG6	-
(5)	20,000	8	6	144	30	12	6	10	0.100	87100357	SPV 100-6 S8	-
(6)	10,000	6	3	150	30	11.5	-	-	0.055	87100362	SPV 150-3 S6	-
(7)	10,000	8	6	150	30	13.5	-	-	0.082	87100363	SPV 150-6 S8	-
(8)	10,000	8	8	150	30	15.9	-	-	0.110	87100134	SPV 150-8 S8	-



Extensions for drive spindles, imperial version

Allow access to difficult-to-reach areas and are clamped into the collet of the machine (air or electric grinder) or into the flexible shaft handpiece.

Special features:

- Cost-effective alternative to customized burrs and mounted points with long shanks.

Image	Max. RPM	Shank mounting dia. S [inch]	Tool mounting [inch]	Total length L ₁ [inch]	Mounting pin length L ₂ [inch]	Max. spindle dia. D [inch]	Incl. collet dia. [mm]	Collet group	Net weight [kg]	Item no.	Designation	Price/unit EUR
(1)	44,000	1/4	1/8	3,07	1,18	0.37	1/8	14	0.028	89912000	SPV 50-1/8 S1/4	-
(2)	20,000	SPG6	1/4	4,09	Special	0.47	1/4	10	0.073	89912001	SPV 75-1/4 SPG6	-
			3/8	4,72	1,18	0.47	1/4	10	0.077	89912002	SPV 75-1/4 S3/8	-
(3)	20,000	SPG6	1/4	5,08	Special	0.47	1/4	10	0.096	89912003	SPV 100-1/4 SPG6	-

Continued on next page



Accessories for tool drives

Extensions



Image	Max. RPM	Shank mounting dia. S [inch]	Tool mounting [inch]	Total length L ₁ [inch]	Mounting pin length L ₂ [inch]	Max. spindle dia. D [inch]	Incl. collet dia. [mm]	Collet group	Net weight [kg]	Item no.	Designation	Price/unit EUR
(4)	20,000	3/8	1/4	5,67	1,18	0.47	1/4	10	0.100	89912004	SPV 100-1/4 S3/8	-
(5)	10,000	1/4	1/8	5,91	1,18	0.45	-	-	0.055	89912005	SPV 150-1/8 S1/4	-
(6)	10,000	3/8	1/4	5,91	1,18	0.53	-	-	0.082	89912006	SPV 150-1/4 S3/8	-



Extensions for drive spindles

Allows access to difficult-to-reach areas and particularly deep cores. They are clamped into the collet of the machine (air or electric grinder) or into the flexible shaft handpiece. They must also be guided by hand.

Contents:

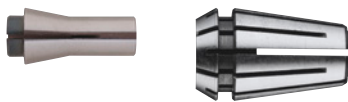
2 keys (2x DM SW 6/7 mm or 2x DM SW 9/11 mm).

Special features:

- The extension is only suitable for manual applications.
- Cost-effective alternative to customized burrs and mounted points with long shanks.

Image	Max. RPM	Shank mounting dia. S [mm]	Tool mounting [mm]	Total length L ₁ [mm]	Mounting pin length L ₂ [mm]	Max. spindle dia. D [mm]	Incl. collet dia. [mm]	Collet group	Net weight [kg]	Item no.	Designation	Price/unit EUR
(1)	25,000	6	3	406	28	9	3	2	0.130	87101310	SPVH9 L300-3 S6	-
				606	28	9	3	2	0.340	87101457	SPVH9 L500-3 S6	-
				906	28	9	3	2	0.520	87101502	SPVH9 L800-3 S6	-
				1,106	28	9	3	2	0.640	87101504	SPVH9 L1000-3 S6	-
(2)	25,000	6	6	406	28	13	6	10	0.320	87101503	SPVH13 L300-6 S6	-
				606	28	13	6	10	0.502	87101280	SPVH13 L500-6 S8	-
		6	6	906	28	13	6	10	0.770	87101506	SPVH13 L800-6 S6	-
				1,106	28	13	6	10	0.950	87101309	SPVH13 L1000-6 S6	-
		8	6	406	28	13	6	10	0.322	87101289	SPVH13 L300-6 S8	-
				606	28	13	6	10	0.500	87101429	SPVH13 L500-6 S6	-
		8	6	906	28	13	6	10	0.772	87101290	SPVH13 L800-6 S8	-
				1,106	28	13	6	10	0.952	87101372	SPVH13 L1000-6 S8	-

Collets



Collets

Depending on the PFERD tool selected, different collets are available. Matching collets are allocated to every drive.

Diameter [mm]	Diameter [inch]	Net weight [kg]	Item no.	Designation	Price/unit EUR
Collet group 1					
2.34	-	0.002	91491301	SPZ 914.913.01 (2,34 mm)	-
3	-	0.002	91491302	SPZ 914.913.02 (3 mm)	-
-	3/32	0.002	91491307	SPZ 914.913.07 (3/32")	-
	1/8	0.002	91491303	SPZ 914.913.03 (1/8")	-
Collet group 2					
2.34	-	0.001	94701604	SPZ 947.016.04 (2,34 mm)	-
3	-	0.001	94701601	SPZ 947.016.01 (3 mm)	-
-	3/32	0.001	94701603	SPZ 947.016.03 (3/32")	-
	1/8	0.001	94701602	SPZ 947.016.02 (1/8")	-

Continued on next page

Diameter [mm]	Diameter [inch]	Net weight [kg]	Item no.	Designation	Price/unit EUR
Collet group 3					
3	-	0.003	90000273	SPZ 900.002.73 (3 mm)	-
-	1/8	0.003	90000282	SPZ 900.002.82 (1/8")	-
Collet group 4					
3	-	0.005	95771703	SPZ 957.717.03 (3 mm)	-
6	-	0.003	95771701	SPZ 957.717.01 (6 mm)	-
-	1/8	0.005	95771704	SPZ 957.717.04 (1/8")	-
-	1/4	0.003	95771702	SPZ 957.717.02 (1/4")	-
Collet group 5					
3	1/8	0.004	90000339	SPZ 900.003.39 (3 mm, 1/8")	-
6	-	0.003	90000340	SPZ 900.003.40 (6 mm)	-
-	1/4	0.004	90000301	SPZ 900.003.01 (1/4")	-
Collet group 6					
3	-	0.013	95032503	SPZ 950.325.03 (3 mm)	-
5	-	0.012	95032506	SPZ 950.325.06 (5 mm)	-
6	-	0.012	95032501	SPZ 950.325.01 (6 mm)	-
8	-	0.007	95032517	SPZ 950.325.17 (8 mm)	-
-	3/32	0.007	95032516	SPZ 950.325.16 (3/32")	-
-	1/8	0.013	95032504	SPZ 950.325.04 (1/8")	-
-	1/4	0.012	95032502	SPZ 950.325.02 (1/4")	-
Collet group 7					
3	1/8	0.015	90000145	SPZ 900.001.45 (3 mm, 1/8")	-
6	-	0.015	90000123	SPZ 900.001.23 (6 mm)	-
8	-	0.015	90000143	SPZ 900.001.43 (8 mm)	-
-	1/4	0.015	90000144	SPZ 900.001.44 (1/4")	-
-	3/8	0.015	90000100	SPZ 900.001.00 (3/8")	-
Collet group 8					
6	-	0.026	95203402	SPZ 952.034.02 (6 mm)	-
8	-	0.026	95203405	SPZ 952.034.05 (8 mm)	-
10	-	0.026	95203407	SPZ 952.034.07 (10 mm)	-
-	1/4	0.026	95203403	SPZ 952.034.03 (1/4")	-
-	3/8	0.021	95203409	SPZ 952.034.09 (3/8")	-
Collet group 9					
2.34	3/32	0.010	91490009	SPZ 914.900.09 (2,34 mm, 3/32")	-
3	-	0.010	91490011	SPZ 914.900.11 (3 mm)	-
5	-	0.008	91490016	SPZ 914.900.16 (5 mm)	-
6	-	0.008	91490018	SPZ 914.900.18 (6 mm)	-
-	1/8	0.010	91490019	SPZ 914.900.19 (1/8")	-
-	1/4	0.008	91490020	SPZ 914.900.20 (1/4")	-
Collet group 10					
3	-	0.006	95766301	SPZ 957.663.01 (3 mm)	-
5	-	0.006	95766304	SPZ 957.663.04 (5 mm)	-
6	-	0.006	95766303	SPZ 957.663.03 (6 mm)	-
-	1/8	0.006	95766302	SPZ 957.663.02 (1/8")	-
-	1/4	0.006	95766351	SPZ 957.663.51 (1/4")	-
Collet group 11					
2.34	3/32	0.017	91490909	SPZ 914.909.09 (2,34 mm, 3/32")	-
3	-	0.017	91490912	SPZ 914.909.12 (3 mm)	-
5	-	0.017	91490917	SPZ 914.909.17 (5 mm)	-
6	-	0.015	91490919	SPZ 914.909.19 (6 mm)	-
8	-	0.013	91490923	SPZ 914.909.23 (8 mm)	-
-	1/8	0.017	91490927	SPZ 914.909.27 (1/8")	-

Continued on next page



Accessories for tool drives

Collets



Diameter [mm]	Diameter [inch]	Net weight [kg]	Item no.	Designation	Price/unit EUR
-	1/4	0.013	91490926	SPZ 914.909.26 (1/4")	-
Collet group 12					
5	-	0.036	91490203	SPZ 914.902.03 (5 mm)	-
6	-	0.035	91490204	SPZ 914.902.04 (6 mm)	-
8	-	0.028	91490206	SPZ 914.902.06 (8 mm)	-
10	-	0.025	91490208	SPZ 914.902.08 (10 mm)	-
12	-	0.024	91490209	SPZ 914.902.09 (12 mm)	-
-	1/4	0.037	91490210	SPZ 914.902.10 (1/4")	-
-	3/8	0.030	91490211	SPZ 914.902.11 (3/8")	-
Collet group 13					
2.34	3/32	0.006	90101823	SPZ 901.018.23 (2,34 mm, 3/32")	-
3	-	0.006	90101830	SPZ 901.018.30 (3 mm)	-
5	-	0.006	90101850	SPZ 901.018.50 (5 mm)	-
6	-	0.006	90101860	SPZ 901.018.60 (6 mm)	-
-	1/8	0.006	90101818	SPZ 901.018.18 (1/8")	-
-	1/4	0.006	90101814	SPZ 901.018.14 (1/4")	-
Collet group 14					
2.34	3/32	0.003	90110423	SPZ 901.104.23 (2,34 mm, 3/32")	-
3	-	0.003	90110430	SPZ 901.104.30 (3 mm)	-
-	1/8	0.003	90110418	SPZ 901.104.18 (1/8")	-
Collet group 15					
3	-	0.018	98980000	SPZ 989.800.00 (3 mm)	-
-	3/32	0.002	98980002	SPZ 989.800.02 (3/32")	-
-	1/8	0.002	98980001	SPZ 989.800.01 (1/8")	-
Collet group 16					
3	-	0.010	98980268	SPZ 98980268 (3 mm)	-
6	-	0.018	98980163	SPZ 989.801.63 (6 mm)	-
8	-	0.018	98980164	SPZ 989.801.64 (8 mm)	-
10	-	0.018	98980165	SPZ 989.801.65 (10 mm)	-
12	-	0.034	98980269	SPZ 98980269 (12 mm)	-
-	1/4	0.018	98980166	SPZ 989.801.66 (1/4")	-
Collet group 17					
2.35	-	0.002	90014051	SPZ 900.140.51 (2,35 mm)	-
3	-	0.002	90014050	SPZ 900.140.50 (3 mm)	-
-	1/8	0.002	90014052	SPZ 900.140.52 (1/8")	-
Collet group 18					
2.35	-	0.001	90014061	SPZ 900.140.61 (2,35 mm)	-
3	-	0.001	90014060	SPZ 900.140.60 (3 mm)	-
-	1/8	0.001	90014062	SPZ 900.140.62 (1/8")	-
Collet group 19					
2.35	-	0.011	90014073	SPZ 900.140.73 (2,35 mm)	-
3	-	0.011	90014071	SPZ 900.140.71 (3 mm)	-
6	-	0.007	90014070	SPZ 900.140.70 (6 mm)	-
-	1/8	0.011	90014072	SPZ 900.140.72 (1/8")	-
-	1/4	0.008	90014074	SPZ 900.140.74 (1/4")	-
Collet group 20					
3	-	0.008	98980262	SPZ 98980262 (3 mm)	-
6	-	0.018	98980261	SPZ 98980261 (6 mm)	-
8	-	0.021	98980263	SPZ 98980263 (8 mm)	-
10	-	0.028	98980264	SPZ 98980264 (10 mm)	-
-	1/4	0.018	98980265	SPZ 98980265 (1/4")	-

Continued on next page



Diameter [mm]	Diameter [inch]	Net weight [kg]	Item no.	Designation	Price/unit EUR
Collet group 21					
3	-	0.010	98980311	SPZ 98980311 (3 mm)	-
6	-	0.010	98980310	SPZ 98980310 (6 mm)	-
-	1/8	0.010	98980398	SPZ 98980398 (1/8")	-
-	1/4	0.010	98980399	SPZ 98980399 (1/4")	-
Collet group 22					
3	-	0.024	98960171	SPZ 98960171 (3 mm)	-
6	-	0.024	98960172	SPZ 98960172 (6 mm)	-
8	-	0.021	98960173	SPZ 98960173 (8 mm)	-
-	1/4	0.024	98960170	SPZ 98960170 (1/4")	-
Collet group 23					
3	-	0.018	98980660	SPZ 98980660 (3 mm)	-
-	3/32	0.018	98980661	SPZ 98980661 (3/32")	-
-	1/8	0.018	98980662	SPZ 98980662 (1/8")	-

Reducing collets and adapter

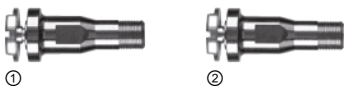


Reducing collets and adapter

Reducing collets fit into an existing collet for 6 mm shank tools and are used as adapters for shank tools.

Image	Reducing shank holder	Suitable for	Net weight [kg]	Item no.	Designation	Price/unit EUR
(1)	from 6 mm to 3 mm diameter	-	0.004	87100162	RZH 63	-
	from 6 mm to 2.34 mm diameter	-	0.004	87100153	RZH 6234	-
	Dia. from 6 mm to 4 mm	-	0.004	87101375	RZH 64	-
(2)	-	Cordless angle grinder with SBH/SBHR 20, 25, 38, 50	0.006	84205030	AF M5 CD 1/4-20 UNC	-

Arbor



Arbor

PFERD offers arbors as accessories.

Image	Shank holder	Tool mounting dia. [mm]	Suitable for	Net weight [kg]	Item no.	Designation	Price/unit EUR
(1)	SPG6	Dia. 6 x 0 – 10	All drives with SPG6	0.035	80810011	BO SPG 6/6 0-10	-
(2)	SPG6	Dia. 10 x 0 – 10	All drives with SPG6	0.035	80810012	BO SPG 6/10 0-10	-



Accessories for tool drives

Key



Key

PFERD offers different keys with different widths across flats (SW).

Image	Net weight [kg]	Item no.	Designation	Price/unit EUR
Hexagon L-wrench				
(1)	0.003	98980670	SKS size 2,5 mm	-
	0.004	90200021	SKS SW 2,5 mm	-
	0.005	92785501	SKS SW 3 mm	-
	0.006	92785502	SKS SW 4 mm	-
	0.018	92785503	SKS SW 5 mm	-
	0.008	90001869	SKS SW 5/32"	-
Hexagon handle wrench				
(1)	0.059	87200313	SKHS size 5 mm	-
Hexagon socket spanner				
(1)	0.073	91243601	SKST size 17 mm	-
Single-head spanner				
(3)	0.008	90001914	EM SW 7 mm	-
	0.014	93785706	EM SW 8 mm G	-
	0.023	95770101	EM SW 9 mm	-
	0.026	90000299	EM SW 10 mm	-
	0.025	93785701	EM SW 11 mm	-
	0.027	98980322	EM SW 12 mm	-
	0.061	98960042	EM SW 13 mm	-
	0.038	93785703	EM SW 14 mm	-
	0.048	98980561	EM size 15 mm	-
	0.062	92785611	EM SW 17 mm	-
	0.102	93785705	EM SW 22 mm	-
	0.022	90000274	EM SW 13/64"	-
	0.040	90000377	EM SW 7/16"	-
	0.010	90000121	EM SW 9/16"	-
	0.015	90000122	EM SW 3/4"	-
Double open-ended spanner				
(2)	0.005	90014010	DM SW 4/4 mm	-
	0.025	98980010	DM SW 6/8 mm	-
	0.020	90014004	DM SW 10/10 mm	-
	0.149	98980190	DM SW 20/22 mm	-
Face pin spanner				
(4)	0.122	91244601	STL SW 35x5 mm	-
	0.048	98960182	STL SW 35x5,3 mm	-
C-wrench				
-	0.095	87200281	HS 40-42	-
Allen key				
(4)	0.006	92792301	STS D 2,5 mm	-
	0.015	92792302	STS D 4 mm	-
	0.034	92792303	STS D 6 mm	-

Continued on next page

Image	Net weight [kg]	Item no.	Designation	Price/unit EUR
Torx key				
-	0.053	87200263	SDR TX 15K	-
Lock sleeve for MIM system				
-	0.032	90014003	MIM ARH	-
Collet key for MIM system				
-	0.022	90014008	MIM SPS DK D 7	-
Lock spanner for MIM system				
-	0.040	90014009	MIM ARS HA D 23,5	-
Double pin spanner for MIM system				
-	0.004	90014011	MIM DSTS SW 11xD 2,4 mm	-

Maintenance accessories



Special lubricating oil 5 L

Special lubricating oil for air-powered devices with oil mist lubrication.

Contents	Use for	Net weight [kg]	Item no.	Designation	Price/unit EUR
Special lubricating oil 5 L	Oil mist device	4.900	80900013	5 L ONG OEL	-



Special lubricating oil 1 L

Special lubricating oil for air-powered devices with oil mist lubrication.

Contents	Use for	Net weight [kg]	Item no.	Designation	Price/unit EUR
Special lubricating oil 1 L	Oil mist device	0.990	80900014	1 L ONG OEL	-



Maintenance set P-Set BW 4/6

Set for maintaining flexible shafts.



Contents:

1 hose brush BW 4/6 for removing the old grease from the flexible casing, 1x flexible shaft grease FT 4, 2 non-linting cleaning cloths (400 x 330 mm).

Contents	Use for	Net weight [kg]	Item no.	Designation	Price/unit EUR
2 cloths, flexible shaft grease FT 4, hose brush BW 4/6	BW 4, BW 6	0.770	86396005	P-Set BW 4/6	-

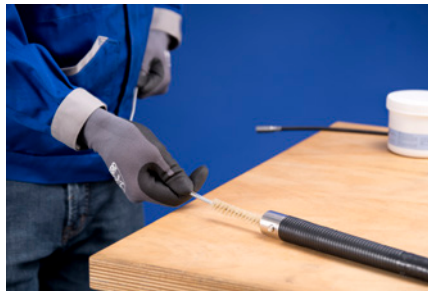
Accessories for tool drives

Maintenance accessories



Maintenance set P-Set BW 7

Set for maintaining flexible shafts.



Contents:

1 hose brush BW 7 for removing the old grease from the flexible casing, 1x flexible shaft grease FT 4, 2 non-linting cleaning cloths (400 x 330 mm).

Contents	Use for	Net weight [kg]	Item no.	Designation	Price/unit EUR
2 cloths, flexible shaft grease FT 4, hose brush BW 7	BW 7	0.770	86396007	P-Set BW 7	-



Maintenance set P-Set BW 10/12

Set for maintaining flexible shafts.

Contents:

1 hose brush BW 10/12 for removing the old grease from the flexible casing, 1x flexible

shaft grease FT 4, 2 non-linting cleaning cloths (400 x 330 mm).

Contents	Use for	Net weight [kg]	Item no.	Designation	Price/unit EUR
2 cloths, flexible shaft grease FT 4, hose brush BW 10/12	BW 10, BW 12	0.770	86396006	P-Set BW 10/12	-



Flexible shaft grease 450 g

Flexible shaft grease with special lubrication and adhesive properties for flexible shafts.



Contents	Use for	Net weight [kg]	Item no.	Designation	Price/unit EUR
Flexible shaft grease 450 g	Flexible shafts	0.450	86396010	FT 4	-

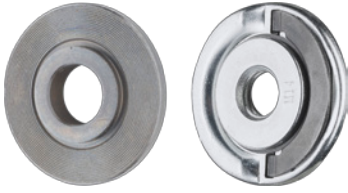


Special grease 100 g

Special grease for re-greasing angle heads.

Contents	Use for	Net weight [kg]	Item no.	Designation	Price/unit EUR
Special grease 100 g	Ball bearing, angle head	0.100	84900498	FT 5	-





Clamping flanges

PFERD offers clamping flanges for tool drives.

Net weight [kg]	Item no.	Designation	Price/unit EUR
0.116	90011456	SPF 90011456 M150	-
0.160	90011457	SPF 90011457 K150/180	-
0.101	90011458	SPF 90011458 H150/180	-
0.140	90011459	SPF 90011459 M180	-
0.084	90011451	SPM 90011451 M14 T150	-
0.126	90011452	SPM 90011452 M14 T180	-
0.059	90011455	SPF 90011455	-
0.098	98960180	SPF 98960180	-
0.051	98970043	SPF 98970043	-
0.069	90011450	SPM 90011450 M14	-
0.098	98960181	SPM 98960181	-
0.066	98980036	SPM 98980036 M14	-
0.610	98970042	SSM 98970042	-
0.008	98980039	DHFL 98980039	-
0.010	98980040	DHTR 98980040	-
0.018	90011460	DS 90011460	-
0.003	98980037	FLS 98980037	-
0.010	98980038	FLS-CC 98980038	-

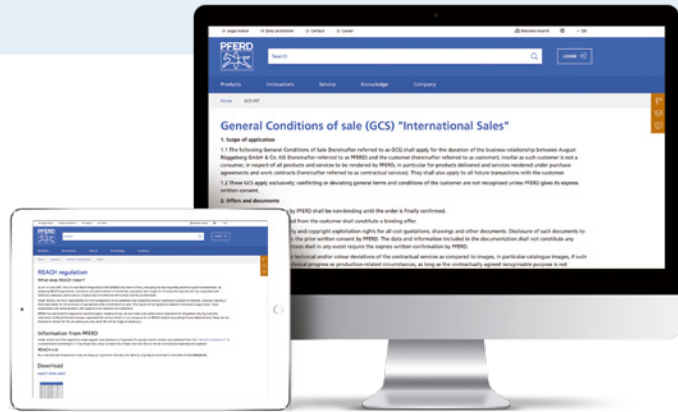


General terms and conditions of sale

Our general terms and conditions of sale apply, which you can view at www.pferd.com/conditions.



Scan the QR code for more information about our general terms and conditions of sale.



New in the PFERD product range

Our new products have **blue** item numbers in the Tool Manual. Discontinued products are in *italics* and identified accordingly in the corresponding product tables.



Stay up to date and discover our new products digitally and online.

REACH Regulation (EC) No. 1907/2006

By adopting REACH (registration, evaluation and authorisation of chemicals), legislators have sought to minimize the hazards and risks associated with chemical substances and to ensure a higher level of protection for humans and the environment.



Information about PFERD tools in the context of the EC REACH Regulation can be found on our website www.pferd.com/reach.

PFERD repair service

Our highly experienced team at our Marienheide plant in Germany ensures that repairs are carried out quickly and looks after the provision of spare parts. Please send any queries to: pferd.power.tools@pferd.com