

PFERD

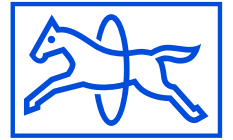

TOOLS



Industrial power brushes



Industrial power brushes

- Highlights from the PFERD TOOLS range 4
- Filament materials and their application 5
- The quick way to find the perfect tool 7
- Safety notes 10
- Cutting speeds 11
- Well packaged and presented 12



Threaded cup brushes

- crimped 13
- knotted 14



Threaded bevel brushes

- crimped 17
- knotted 18

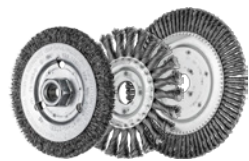

Wheel brushes

- crimped 20
- knotted 21
- Pipeline 24
- knotted, stationary 25
- crimped, with hole 26



Composite brushes

- Wheel brushes, crimped 32
- Composite disc brushes, crimped 34
- Shank-mounted end brushes, crimped 36



Shank-mounted end brushes

- crimped 37
- knotted 40



Shank-mounted cup brushes

- crimped 42

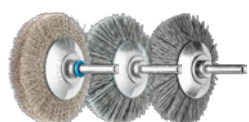

Shank-mounted bevel brushes

- crimped 44

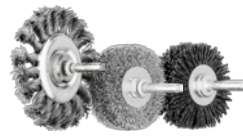

Shank-mounted wheel brushes

- crimped 46
- knotted 49



Brush sets

- Brush sets 50



Wheel brushes for burnishing machines

- crimped 51

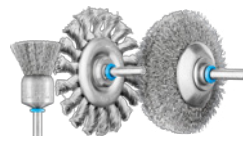

INOX-TOTAL

- Wheel brushes 52
- Shank-mounted end brushes 53
- Shank-mounted wheel brushes 54
- Shank-mounted bevel brushes 55
- Shank-mounted cup brushes 56



Miniature brushes

- End brushes, crimped 57
- Cup brushes, crimped 58
- Wheel brushes, crimped 59



Tube brushes

- Tube brushes 61



Universal brushes

- Shank-mounted universal cup brushes, crimped 66
- Shank-mounted universal wheel brushes, crimped 67

Industrial power brushes

Table of contents

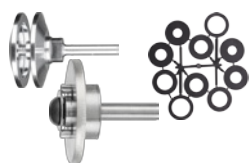

Accessories

- Arbor
- Adapter
- Accessories for tube brushes

68
69
70



Scratch brushes

- Scratch brushes

72

Industrial power brushes

Highlights from the PFERD TOOLS range



Composite brushes for stationary applications

PFERD TOOLS offers a comprehensive range of high-quality industrial power brushes, specially designed for stationary applications on robots and CNC machines.



Composite brushes from PFERD TOOLS are specially designed for the demands of automated workpiece machining. Compared to conventional metal constructions, they feature an extremely high filament density and a very even distribution of the filament material. This guarantees a long tool life and extremely smooth running.

All of the industrial power brushes made by PFERD TOOLS can also be used on robots.

Industrial power brushes in stationary applications are most commonly used for deburring and rounding edges, processing holes and female threads, work on surfaces and cleaning.

Scan the QR code to find out more about composite brushes for stationary applications.

Advantages:

- Long tool life and aggressive brushing effect due to a very high filament density.
- High flexibility due to their ability to adapt to contours. Robots that are used with industrial power brushes are easier to program and can often be used without compliance.
- Very reliable process with extremely smooth operation due to even distribution of the filament material.

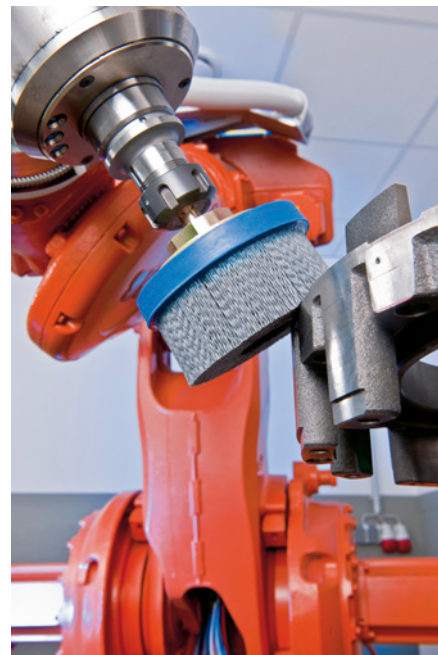

INOX-TOTAL

In addition to brushes with a stainless steel filament, PFERD TOOLS also offers brushes for work on stainless steel (INOX) with the INOX-TOTAL type. They are particularly well-suited to use in extremely critical environments.



Structure of a wheel brush with arbor hole INOX-TOTAL:

- ① Side plates made of stainless steel (INOX)
- ② Centre disc made of stainless steel (INOX)
- ③ Filament made of stainless steel (INOX)

Scan the QR code to find out more about INOX-TOTAL brushes.

Advantages:

- Maximum protection against corrosion as all components are produced from stainless steel (INOX) in quality 1.4310/1.4301 (V2A).

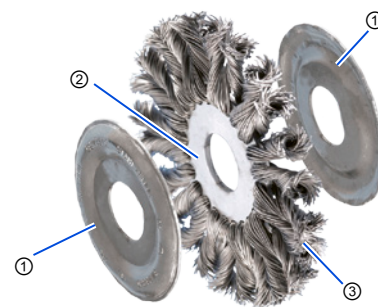

Brushes with cord wire filament

Aggressive yet flexible – industrial power brushes with cord wire offer the perfect combination of aggressive brushing effect and flexibility. With this special wire construction, multiple wavy wire filaments are stranded together. As a result, they work effectively and aggressively like a knotted brush and, at the same time, flexibly like a wavy brush.



Scan the QR code to find out more about brushes with cord wire.

Advantages:

- More aggressive brushing effect compared to conventional crimped brushes due to the special wire construction which provides the wires with additional stability.
- Perfect for complex geometries and hard-to-reach areas as the many small wires make the cord wire highly flexible.



- Ideally suited to demanding tasks due to the durability and resilience of the individual wires.

More expert information online

Scan the QR code to find out a wide range of tool and application knowledge relating to PFERD TOOLS' high-quality tools and their huge variety of materials.

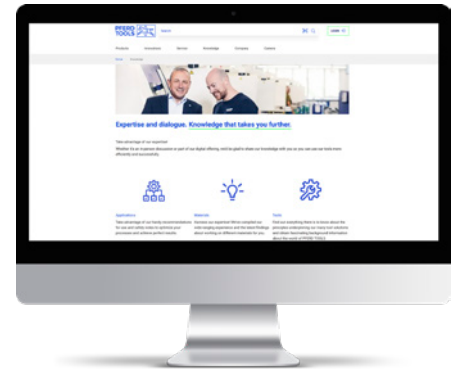

Filament materials and their application

Selecting the filament material

Filament material	Material to be working on						Cast iron	Plastics
	Steel	Stainless steel (INOX)	Non-ferrous metals					
			Aluminium	Soft non-ferrous metals Brass, copper, zinc	Hard non-ferrous metals Titanium, bronze, nickel-based and cobalt-based alloys			
Steel wire (ST)	●	-	-	-	-	●	○	
Steel cord wire (LIT ST, LIT STM)	●	-	-	-	-	●	○	
Stainless steel wire (INOX)	○	●	●	○	○	-	-	
Stainless steel cord wire (LIT INOX)	○	●	●	○	○	-	-	
Stainless steel wire (INOX) Diamond (DIA)	○	-	-	-	●	●	●	
Brass wire (MES)	-	-	-	●	-	-	-	
Silicon carbide (SiC)	●	●	●	-	○	●	●	
Aluminium oxide (AO)	○	○	●	-	-	○	○	
Ceramic oxide grain (CO)	●	○	○	-	●	●	-	
Diamond (DIA)	○	-	-	-	●	●	●	
Nylon	-	-	○	○	-	-	●	
Bristle and goat hair (with polishing paste)	●	●	●	●	●	●	●	

● = highly suitable ○ = suitable - = not suitable

Wire filament

- **Crimped brushes (wavy wire):** for work with particular requirements on the flexibility of the brushes, such as machining of highly contoured workpieces.
- **Knotted brushes (straight wire):** for work that requires aggressive brushing behaviour, such as work on weld seams.



Steel wire (ST, LIT ST)

Advantages/properties:

- PFERD TOOLS special wire with high tensile strength and bending fatigue strength.
- Guarantees a long tool life, even for extreme brushing applications.
- Temperature resistance: up to 300°C

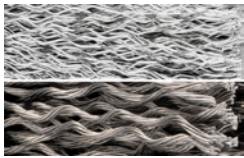

Stainless steel wire (INOX, LIT INOX)

Advantages/properties:

- Wire quality 1.4310/1.4301 (V2A): stainless; does not leave corroding residues on the workpiece.
- Used with low rotational speeds, compared to steel wire.
- PFERD TOOLS brushes with INOX filament are usually degreased.
- Temperature resistance: up to 450°C



Stainless steel wire (INOX) diamond (DIA)

Advantages/properties:

- Particularly well suited to applications that place particular demands on the aggressiveness of the brush.
- Primarily used on materials with high material strength.
- Temperature resistance: up to 450°C

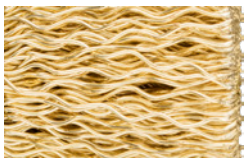

Brass wire (MES)

Advantages/properties:

- Wire quality CuZn37: brass wire is softer than steel wire.
- It is non-sparking and produces fine surface finishes.
- Temperature resistance: up to 180°C

Plastic filament

- Abrasive grains are embedded in flexible plastic filaments, which means that the filament works on the sides as well as at the tip.
- **Round filament:** for applications that place particular demands on the flexibility of the brush.
- **Rectangular filament (REC):** for applications that place particular demands on the aggressiveness of the brush.
- Recommendation for use: Use coolant for applications where large amounts of heat are produced.

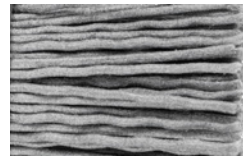

Silicon carbide (SiC)

Advantages/properties:

- Particularly well suited to deburring work and for improving surfaces.
- Temperature resistance up to 220°C



Aluminium oxide (AO)

Advantages/properties:

- Less sharp-edged and aggressive compared with SiC.
- Primarily suitable for polishing and smoothing finishes on soft metals.
- Temperature resistance up to 220°C

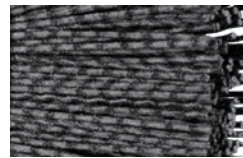

Ceramic oxide grain (CO)

Advantages/properties:

- Offers good toughness and excellent sharpness.
- For high stock removal and aggressive brushing.
- Temperature resistance up to 220°C



Diamond (DIA)

Advantages/properties:

- Particularly well suited to applications that place particular demands on the aggressiveness of the brush.
- Primarily used on materials with high material strength.
- Temperature resistance up to 220°C

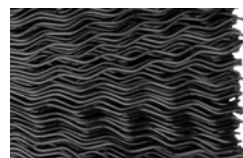

Nylon

Advantages/properties:

- Particularly suited to working with materials that would otherwise be scratched or damaged, e.g. soft plastics.
- Temperature resistance up to 220°C

Natural bristles

- Primarily suitable for light cleaning and dust removal, as well as for polishing (in combination with polishing pastes).



White (SBW) and black (SBS) bristles

Advantages/properties:

- Bristles are harder and less flexible than brushes with goat hair filament.
- Temperature resistance: up to 150°C

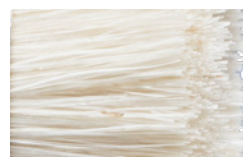

Goat hair (ZHW)

Advantages/properties:

- Goat hair is more flexible and softer than bristle.
- Temperature resistance: up to 150°C











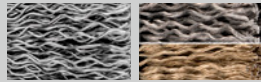

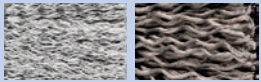

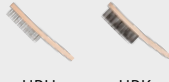





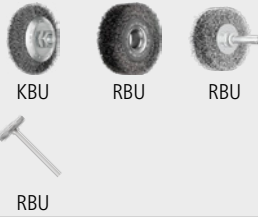

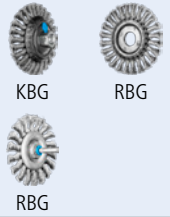
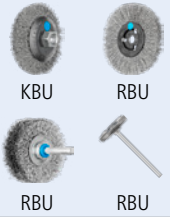



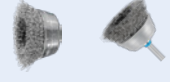



Industrial power brushes









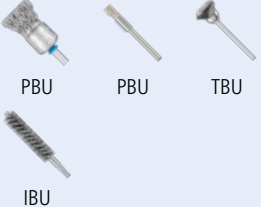

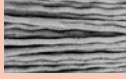

















The quick way to find the perfect tool



- ① **Select the filament material.** The material that you are working with is key to determining the optimum filament material.
 - ② **Select the filament type.** The brushing effect you want determines which filament type to choose.
 - ③ **Select the tool.** The application and geometry of the workpiece indicate the optimum brush.
-





Materials that can be worked	Steel, cast iron, plastics			Stainless steel (INOX), aluminium, other non-ferrous metals		
Filament material	Steel wire (ST, LIT ST, LIT STM) Colour code: grey			Stainless steel wire (INOX, LIT INOX) Colour code: blue		
Filament type	 knotted	 crimped	 encapsulated	 knotted	 crimped	
Desired effect	Aggressive brushing effect, less flexible	Light brushing effect, flexible	Very aggressive brushing effect, not flexible	Aggressive brushing effect, less flexible	Light brushing effect, flexible	
Weld seam	 RBG RBG PIPE	 HBU HBK	 RBV	 RBG RBG PIPE	 HBU HBK	
Structuring surfaces		 RBU RBU SC WBU			 RBU WBU	
Edge deburring	 KBG RBG RBG	 KBU RBU RBU RBU	 RBV	 KBG RBG RBG	 KBU RBU RBU RBU	
Surface deburring	 TBG	 TBU TBU		 TBG	 TBU TBU	
Interior deburring	 PBG	 PBU PBU TBU IBU	 PBV	 PBG	 PBU PBU TBU IBU	
Surface cleaning	 TBG KBG RBG RBG	 TBU KBU RBU RBU HBU		 TBG KBG RBG RBG	 TBU KBU RBU RBU HBU	
Interior cleaning	 PBG	 PBU PBU TBU	 PBV	 PBG	 PBU PBU TBU IBU	

Materials that can be worked	Brass, copper, other non-ferrous metals	Steel, stainless steel (INOX), aluminium, non-ferrous metals, titanium, cast, plastics, wood	Steel, stainless steel (INOX), non-ferrous metals, cast iron
Filament material	Brass wire (MES) Colour code: yellow	Plastic filament (SiC, CO, nylon) Colour code: red	Natural materials Colour code: brown
Filament type	 crimped	 crimped	 crimped
Desired effect	Light brushing effect, flexible	Grinding brushing effect, very flexible	Light brushing effect (use with polishing pastes)
Weld seam 	 HBU		
Structuring surfaces 		 RBU	 RBUP
Edge deburring 	 RBU	 RBU	 RBU
Surface deburring 		 RBU	 RBUP
Interior deburring 	 PBU	 PBU	 TBU
Surface cleaning 	 RBU	 HBU	 TBU
Interior cleaning 	 PBU	 IBU	 PBU
Polishing 			 RBU

Safety notes:

As one of the leading manufacturers of brush tools, PFERD TOOLS fulfils the requirements of European standard EN 1083. Guidelines on the safe and economic use of PFERD TOOLS brushes are supplied with every packaging unit. They help you to increase your level of personal work safety.

 Wear eye protection!

 Wear hearing protection!

 Wear a dust mask!

 Wear gloves!

 Observe the safety notes!



 Use a protective machine guard!

Maximum permitted rotational speed

In order to guarantee operating safety, the maximum permitted rotational speed indicated on the brush, label and in this catalogue must never be exceeded! Please refer to our product information and product tables for further recommendations regarding optimum operating speeds. These give details of the recommended rotational speeds [RPM] for an optimum working result.

Brush diameter

In the case of hand-held tool drives, the brush diameter should never exceed 180 mm, regardless of the filament material.

Total dia. D of the brush [mm]	Minimum arbor hole dia. D_A [mm]
50	4.6
75	6.5
100	10
150	13
200	16
250	20
300	20
350	32

Minimum arbor hole diameter according to EN 1083

Brushes must comply with the minimum arbor hole diameters (D_A) listed below, depending on their total diameter (D).

Determining the recommended rotational speed

- ① Select the brush type.
- ② Read the recommended cutting speed.
- ③ Determine the rotational speed using the brush diameter and cutting speed.

The recommended cutting speed ranges [m/s] depend on the respective application and lie below the maximum permitted cutting speed.

① Brush type	② Cutting speed
End brushes	5–15 m/s
Cup brushes	15–45 m/s
Shank-mounted wheel brushes	15–40 m/s
Rund-/Kegelbürsten mit Bohrung/Gewinde	See diagram below

② Recommended cutting speed [m/s] for wheel/bevel brushes with arbor hole/threaded.

The colour bars correspond to the colour codes of the filament materials.

Application		[m/s]	10	15	20	25	30	35	40	45	50	55
Deburring/ edge breaking	knotted							35–45 m/s				
							30–40 m/s					
	crimped				25–40 m/s							
				15–30 m/s								
Removal of scale/ mill scale	knotted							35–55 m/s				
							30–40 m/s					
	crimped				20–40 m/s							
				15–30 m/s								
Cleaning/ roughening of surfaces	knotted							35–40 m/s				
							30–35 m/s					
	crimped				15–35 m/s							
				15–30 m/s								
Weld dressing	knotted							35–55 m/s				
							30–40 m/s					
	crimped						30–45 m/s					
					25–40 m/s							

③ Recommended rotational speeds [RPM]

Example:

RBG 11512 ST

Cleaning surfaces

Brush diameter D: 115 mm

Cutting speed: 39 m/s

Rotational speed: 6,500 RPM

n [RPM]	Brush dia. D [mm]																		
	10	15	20	25	30	40	50	60	75	80	100	115	125	150	175	200	250	300	
1,000	1	1	1	1	2	2	3	3	4	4	5	6	7	8	9	10	13	16	
1,250	1	1	1	2	2	3	3	4	5	5	7	8	8	10	11	13	16	20	
1,500	1	1	2	2	2	3	4	5	6	6	8	9	10	12	14	16	20	24	
1,750	1	1	2	2	3	4	5	5	7	7	9	11	11	14	16	18	23	27	
2,000	1	2	2	3	3	4	5	6	8	8	10	12	13	16	18	21	26	31	
2,500	1	2	3	3	4	5	7	8	10	10	13	15	16	20	23	26	33	39	
3,000	2	2	3	4	5	6	8	9	12	13	16	18	20	24	27	31	39	47	
3,500	2	3	4	5	5	7	9	11	14	15	18	21	23	27	32	37	46	55	
4,000	2	3	4	5	6	8	10	13	16	17	21	24	26	31	37	42	52	63	
4,500	2	4	5	6	7	9	12	14	18	19	24	27	29	35	41	47	59	71	
5,000	3	4	5	7	8	10	13	16	20	21	26	30	33	39	46	52	65	79	
5,500	3	4	6	7	9	12	14	17	22	23	29	33	36	43	50	58	72		
6,000	3	5	6	8	9	13	16	19	24	25	31	36	39	47	55	63	79		
6,500	3	5	7	9	10	14	17	20	26	27	34	39	43	51	60	68			
7,000	4	5	7	9	11	15	18	22	27	29	37	42	46	55	64	73			
7,500	4	6	8	10	12	16	20	24	29	31	39	45	49	59	69	79			
8,000	4	6	8	10	13	17	21	25	31	34	42	48	52	63	73				
10,000	5	8	10	13	16	21	26	31	39	42	52	60	65	79					
12,000	6	9	13	16	19	25	31	38	47	50	63	72	79						
14,000	7	11	15	18	22	29	37	44	55	59	73								
16,000	8	13	17	21	25	34	42	50	63	67									
20,000	10	16	21	26	31	42	52	63	79										
22,000	12	17	23	29	35	46	58	69											
25,000	13	20	26	33	39	52	65	79											

$$\text{Cutting speed (v)} = \frac{\text{dia. (D)} \times \pi \times \text{rot. speed (n)}}{1,000 \times 60}$$

Industrial power brushes

Well packaged and presented



Industrial packaging

PFERD TOOLS provides industrial power brushes in industrial packaging (IP) as standard.

Advantages:

- Robust, damage-resistant packaging.

POS packaging

PFERD TOOLS provides wheel, cup, end and bevel brushes in promotional individual packaging. Individually packed shank brushes are supplied in a practical cardboard box. The addition of "POS" in the designation indicates all brushes in POS packaging.

Advantages:

- Functional European standard hole mounting for optimum product presentation on the sales wall.
- Product is easily recognizable through the viewing window.



IP



POS

Dimensions

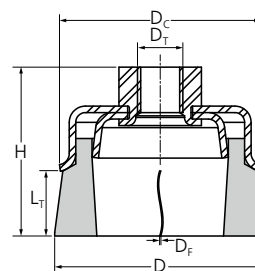
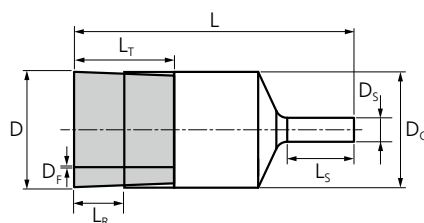
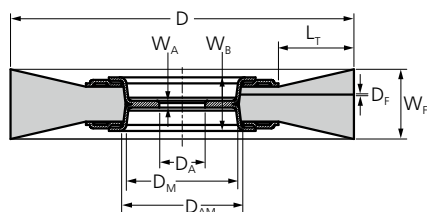

Wheel brushes

End brushes

Cup brushes

Explanation of dimensions

D	Nominal outer diameter of the brush or the working surface for end brushes
D_A	Hole diameter
D_{AM}	Max. hole diameter in main body
D_C	Max. diameter of the main body
D_F	Nominal dimension of the filament material (wire thickness)
D_M	Diameter in hole area

D_S	Shank diameter in shank-mounted brushes, shaft diameter for wheel brushes for burnishing machines, stem diameter (core) for pipe brushes
D_T	Nominal thread designation
H	Nominal total height (incl. components for arbor hole or thread as well as shank)
L	Nominal total length for end brushes (without guide pins) and pipe brushes
L_R	Total length of the filament material (free length without bridle)

L_S	Usable length for shank or stem, total length of the mounting shaft, usable thread length
L_T	Nominal length of the filament material (free length of the filament material)
W_A	Width of the main body at the hole / thread
W_B	Installation width, widest point of the main body
W_F	Nominal dimension of the working width

Threaded cup brushes

Dimensions

Custom-made products

If you cannot find the solution for your particular application in our extensive catalogue range, we can produce brushes in premium PFERD TOOLS quality specifically for your application on request. Products that can be made to order include different wire thicknesses and qualities, arbor holes or threads and other dimensions.

crimped

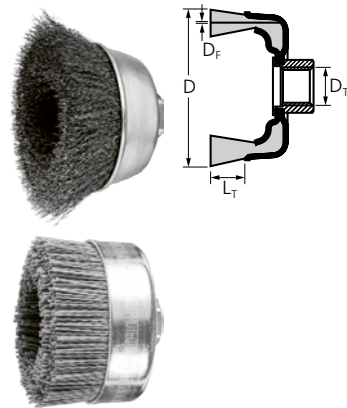

TBU

Excellent for medium-duty brushing such as deburring, cleaning and derusting on large surfaces.



Special features:

- Highly flexible, enabling optimal adjustment to the workpiece contour.
- Creates fine surfaces.

D [mm]	L _T [mm]	D _T	Grit size	D _F [mm]	Opt. RPM	Max. RPM		Item no.	Designation
--------	---------------------	----------------	-----------	---------------------	----------	----------	--	----------	-------------

Steel wire (ST)

60	20	M14x2	-	0.30	6,300 – 9,400	12,500	1	43468902	POS TBU 60/M14 ST 0,30
								5	43468880
75	25	X-LOCK	-	0.30	6,300 – 9,400	12,500	1	43468922	POS TBU 60/X-LOCK ST 0,30
		M14x2	-	0.30				5	43469001
100	25				4,300 – 6,400	8,500	1	43469010	TBU 75/M14 ST 0,30
		M14x2	-	0.30				1	43469102

Stainless steel wire (INOX) – All INOX brushes are degreased.

60	20	M14x2	-	0.30	5,000 – 8,100	12,500	1	43468905	POS TBU 60/M14 INOX 0,30
								5	43468882
75	25	X-LOCK	-	0.30	5,000 – 8,100	12,500	1	43468925	POS TBU 60/X-LOCK INOX 0,30
		M14x2	-	0.30				5	43469003
100	25				3,400 – 5,500	8,500	1	43469012	TBU 75/M14 INOX 0,30
		M14x2	-	0.30				1	43469103

Silicon carbide (SiC) plastic filament

100	46	M14x2	120	1.00	2,400 – 3,900	6,000	1	43469104	POS TBU 100/M14 SiC 120 1,00
-----	----	-------	-----	------	---------------	-------	---	----------	------------------------------

Threaded cup brushes

crimped

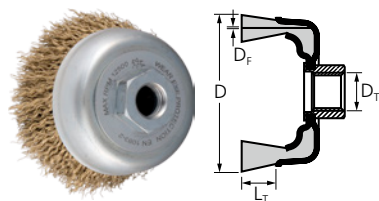

TBU, with cord wire

Excellent for medium-duty brushing such as deburring, cleaning and derusting on large surfaces. Brushes with cord wire are particularly robust and durable and are therefore ideally suited to demanding tasks. Cord wire is made of multiple wavy wires which are stranded together. This special wire construction combines the aggressive brushing effect of a knotted brush with the flexibility of a wavy brush, achieving an excellent surface finish and a longer tool life.

Special features:

- Highly flexible, enabling optimal adjustment to the workpiece contour.
- Aggressive and effective work due to the special wire construction.
- Longer tool life compared to conventional crimped brushes.

D [mm]	L _T [mm]	D _T	D _F [mm]	Opt. RPM	Max. RPM		Item no.	Designation
Brass-plated steel cord wire (LIT STM)								
60	20	M14x2	0.25	6,300 – 9,400	12,500	1	43468881	POS TBU 60/M14 LIT STM 0,25

knotted

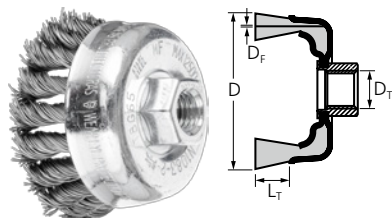

TBG

Aggressive brush. Excellent for heavy-duty brushing such as deburring, cleaning, derusting and descaling and removal of spatter.



Special features:

- Aggressive brushing effect due to the very stiff wire knots.

D [mm]	L _T [mm]	D _T	D _F [mm]	Knots	Opt. RPM	Max. RPM		Item no.	Designation
Steel wire (ST)									
65	22	M14x2	0.35	18	6,300 – 12,500	12,500	1	43305002	POS TBG 65/M14 ST 0,35
								43305020	TBG 65/M14 ST 0,35
								43305001	POS TBG 65/M14 ST 0,50
		X-LOCK	0.50	18	6,300 – 12,500	12,500	1	43305021	TBG 65/M14 ST 0,50
								43305026	POS TBG 65/X-LOCK ST 0,50
M14x2	0.80	18	6,300 – 12,500	12,500	1	43305018	POS TBG 65/M14 ST 0,80		
80	20	M14x2	0.50	20	5,000 – 10,000	10,000	1	43306031	POS TBG 80/M14 ST 0,50
								43306040	TBG 80/M14 ST 0,50
100	25	M14x2	0.50	24	4,500 – 9,000	9,000	1	43308031	POS TBG 100/M14 ST 0,50
								43308040	TBG 100/M14 ST 0,50

Stainless steel wire (INOX) – All INOX brushes are degreased.

65	22	M14x2	0.35	18	5,000 – 12,500	12,500	1	43305003	POS TBG 65/M14 INOX 0,35
								43305023	TBG 65/M14 INOX 0,35
								43305004	POS TBG 65/M14 INOX 0,50
		X-LOCK	0.50	18	5,000 – 12,500	12,500	1	43305024	TBG 65/M14 INOX 0,50
								43305028	POS TBG 65/X-LOCK INOX 0,50
80	20	M14x2	0.35	20	4,000 – 10,000	10,000	1	43306033	POS TBG 80/M14 INOX 0,35
								43306042	TBG 80/M14 INOX 0,35
								43306035	POS TBG 80/M14 INOX 0,50

Continued on next page

Threaded cup brushes

knotted

D [mm]	L _T [mm]	D _T	D _F [mm]	Knots	Opt. RPM	Max. RPM		Item no.	Designation
80	20	M14x2	0.50	20	4,000 – 10,000	10,000	5	43306044	TBG 80/M14 INOX 0,50
100	25	M14x2	0.35	24	3,600 – 9,000	9,000	1	43308033	POS TBG 100/M14 INOX 0,35
							5	43308042	TBG 100/M14 INOX 0,35
			0.50	24	3,600 – 9,000	9,000	1	43308035	POS TBG 100/M14 INOX 0,50
							5	43308044	TBG 100/M14 INOX 0,50

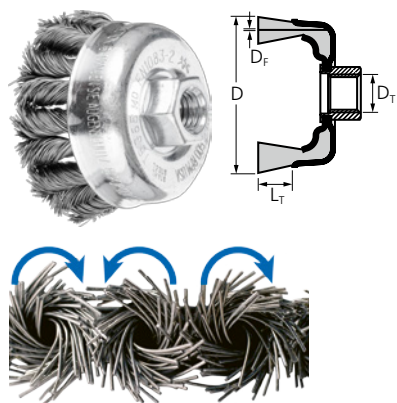

TBG CT, COMBITWIST

Very aggressive brush. Excellent for heavy-duty brushing such as deburring, cleaning, derusting and descaling and removal of spatter. Suitable for work on corners and edges as the knots are less likely to unravel.

Special features:

- Maximum economic efficiency due to maximum tool life and stock removal rate.
- High level of comfort thanks to smooth running with no brush recoiling.
- Aggressive brushing effect due to the very stiff wire knots.

D [mm]	L _T [mm]	D _T	D _F [mm]	Knots	Opt. RPM	Max. RPM		Item no.	Designation
--------	---------------------	----------------	---------------------	-------	----------	----------	---	----------	-------------

Steel wire (ST)

65	22	M14x2	0.35	18	6,300 – 12,500	12,500	1	43305041	POS TBG 65/M14 CT ST 0,35
							5	43305030	TBG 65/M14 CT ST 0,35
			0.50	18	6,300 – 12,500	12,500	1	43305051	POS TBG 65/M14 CT ST 0,50
							5	43305031	TBG 65/M14 CT ST 0,50
80	20	M14x2	0.50	20	5,000 – 10,000	10,000	1	43306061	POS TBG 80/M14 CT ST 0,50
							5	43306070	TBG 80/M14 CT ST 0,50
100	25	M14x2	0.50	24	4,500 – 9,000	9,000	1	43308061	POS TBG 100/M14 CT ST 0,50
							5	43308070	TBG 100/M14 CT ST 0,50

Stainless steel wire (INOX) – All INOX brushes are degreased.

65	22	M14x2	0.35	18	5,000 – 12,500	12,500	1	43305043	POS TBG 65/M14 CT INOX 0,35
			0.50	18	5,000 – 12,500	12,500	1	43305053	POS TBG 65/M14 CT INOX 0,50
80	20	M14x2	0.35	20	4,000 – 10,000	10,000	1	43306063	POS TBG 80/M14 CT INOX 0,35
100	25	M14x2	0.35	24	3,600 – 9,000	9,000	1	43308063	POS TBG 100/M14 CT INOX 0,35

Threaded cup brushes

knotted

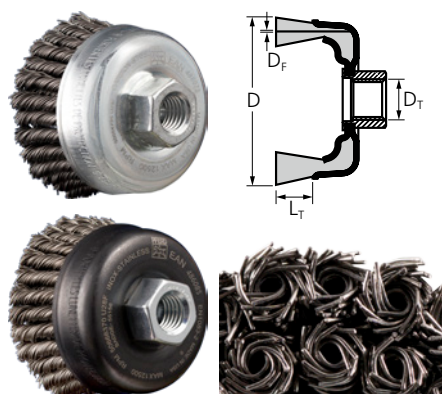

TBG HD, two rows

Double-row, very aggressive and robust brush that is able to withstand high mechanical loads. Excellent for heavy-duty brushing such as deburring, cleaning, derusting and descaling and removal of spatter. Extremely high filament density for optimum tool life.

Special features:

- Double-row design enables fast brushing results thanks to larger filament width.
- High level of comfort thanks to smooth running on corners and edges.
- Aggressive brushing effect due to the very stiff wire knots.

D [mm]	L _T [mm]	D _T	D _F [mm]	Knots	Opt. RPM	Max. RPM		Item no.	Designation
--------	---------------------	----------------	---------------------	-------	----------	----------	---	----------	-------------

Steel wire (ST)

65	22	M14x2	0.50	48	6,300 – 12,500	12,500	1	43305032	POS TBG 65/M14 ST 0,50 2RH HD
----	----	-------	------	----	----------------	--------	---	----------	-------------------------------

Stainless steel wire (INOX) – All INOX brushes are degreased.

65	22	M14x2	0.50	48	5,000 – 12,500	12,500	1	43305033	POS TBG 65/M14 INOX 0,50 2RH HD
----	----	-------	------	----	----------------	--------	---	----------	---------------------------------

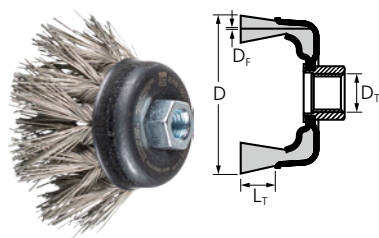

TBG, DIA

Brushes with stainless steel wire (INOX) diamond (DIA) filament material are suitable for applications that place particular demands on the aggressiveness of the brush. They are primarily used on materials with high material strength.

Special features:

- The knots of the brush are knotted to 50% of the length, ensuring an optimal ratio of aggressiveness and flexibility.
- The brush achieves a better surface quality on uneven surfaces than conventional knotted brushes.

D [mm]	L _T [mm]	D _T	Grit size	D _F [mm]	Knots	Opt. RPM	Max. RPM		Item no.	Designation
--------	---------------------	----------------	-----------	---------------------	-------	----------	----------	--	----------	-------------

Stainless steel wire (INOX) diamond (DIA)

65	22	M14x2	270	0.50	18	1,500 – 3,700	12,500	1	43703023	TBG 65/M14 INOX 0,50 DIA 270
100	38	M14x2	270	0.50	24	1,000 – 2,400	9,000	1	43703022	TBG 100/M14 INOX 0,50 DIA 270

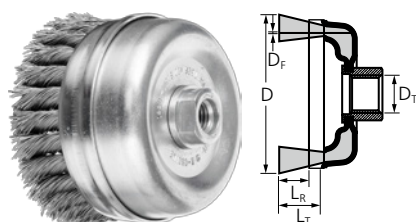

TBGR, with bridle

Aggressive brush with bridle. Excellent for heavy-duty brushing such as deburring, cleaning, derusting and descaling, as well as removing spatter on large areas. The brush impresses with a particularly long tool life.

Special features:

- The bridle prevents the wires spreading out sideways. The bridle enables the spreading out and flexibility of the brush filament to be controlled.
- If the filament has worn away down to the bridle, it can be removed from the bridle for further use. This does not affect the brushing behaviour.
- Aggressive brushing effect due to the very stiff wire knots.

D [mm]	L _R [mm]	L _T [mm]	D _T	D _F [mm]	Knots	Opt. RPM	Max. RPM		Item no.	Designation
--------	---------------------	---------------------	----------------	---------------------	-------	----------	----------	--	----------	-------------

Steel wire (ST)

80	25	40	M14x2	0.50	22	4,300 – 8,500	8,500	1	43306001	TBGR 80/M14 ST 0,50
100	25	40	M14x2	0.50	26	4,300 – 8,500	8,500	1	43308001	TBGR 100/M14 ST 0,50

Threaded bevel brushes

crimped

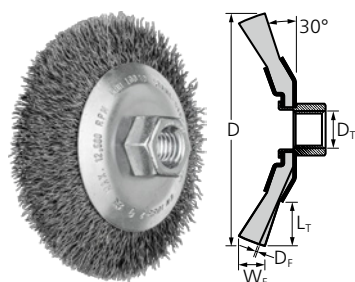

KBU

Excellent for medium-duty brushing such as deburring, cleaning and derusting. Can be used on angle grinders up to 80 m/s.



Special features:

- Optimal access to hard-to-reach areas such as inner edges, grooves and keyways.
- Highly flexible, enabling optimal adjustment to the workpiece contour.
- Creates fine surfaces.

D [mm]	W _F [mm]	L _T [mm]	D _T	D _F [mm]	Opt. RPM	Max. RPM		Item no.	Designation
Steel wire (ST)									
100	10	22	M14x2	0.35	6,300 – 12,500	12,500	1	43316001	POS KBU 10010/M14 ST 0,35
							5	43316010	KBU 10010/M14 ST 0,35
115	10	30	M14x2	0.35	6,300 – 12,500	12,500	1	43316021	POS KBU 11510/M14 ST 0,35
125	10	22	M14x2	0.35	6,300 – 11,000	11,000	5	43220120	KBU 12510/M14 ST 0,35

Stainless steel wire (INOX) – All INOX brushes are degreased.

100	10	22	M14x2	0.35	5,000 – 12,500	12,500	1	43316003	POS KBU 10010/M14 INOX 0,35
							5	43316012	KBU 10010/M14 INOX 0,35
115	10	30	M14x2	0.35	5,000 – 12,500	12,500	1	43316023	POS KBU 11510/M14 INOX 0,35
125	10	22	M14x2	0.35	5,000 – 11,000	11,000	5	43220121	KBU 12510/M14 INOX 0,35

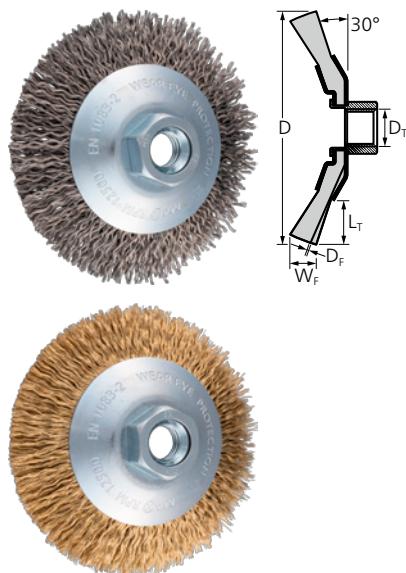

KBU, with cord wire

Excellent for medium-duty brushing such as deburring, cleaning and derusting. Can be used on angle grinders up to 80 m/s. Brushes with cord wire are particularly robust and durable and are therefore ideally suited to demanding tasks. Cord wire is made of multiple wavy wires which are stranded together. This special wire construction combines the aggressive brushing effect of a knotted brush with the flexibility of a wavy brush, achieving an excellent surface finish and a longer tool life.

Special features:

- Highly flexible, enabling optimal adjustment to the workpiece contour.
- Aggressive and effective work due to the special wire construction.
- Longer tool life compared to conventional crimped brushes.

D [mm]	W _F [mm]	L _T [mm]	D _T	D _F [mm]	Opt. RPM	Max. RPM		Item no.	Designation
Brass-plated steel cord wire (LIT STM)									
100	10	20	M14x2	0.20	6,300 – 12,500	12,500	1	43316007	POS KBU 10010/M14 LIT STM 0,20

Stainless steel wire (INOX) – LIT INOX = stranded INOX wire

100	10	20	M14x2	0.30	5,000 – 12,500	12,500	1	43316008	POS KBU 10010/M14 LIT INOX 0,30
-----	----	----	-------	------	----------------	--------	---	----------	---------------------------------

Threaded bevel brushes

knotted

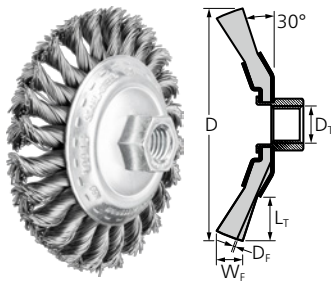

KBG

Aggressive brush. Excellent for heavy-duty brushing such as deburring, cleaning, derusting and descaling and removal of spatter.



Special features:

- Optimal access to hard-to-reach areas such as inner edges, grooves and keyways.
- Aggressive brushing effect due to the very stiff wire knots.

D [mm]	W _F [mm]	L _T [mm]	D _T	D _F [mm]	Knots	Opt. RPM	Max. RPM		Item no.	Designation
Steel wire (ST)										
100	13	22	M14x2	0.50	24	10,000 – 15,000	20,000	1	43313001	POS KBG 10013/M14 ST 0,50
								5	43312910	KBG 10013/M14 ST 0,50
115	15	26	M14x2	0.50	24	7,500 – 12,500	15,000	1	43315001	POS KBG 11515/M14 ST 0,50
								5	43314010	KBG 11515/M14 ST 0,50
125	15	19	M14x2	0.50	28	7,500 – 12,000	15,000	1	43317001	POS KBG 12515/M14 ST 0,50

Stainless steel wire (INOX) – All INOX brushes are degreased.

100	13	22	M14x2	0.35	24	8,600 – 15,000	20,000	1	43313003	POS KBG 10013/M14 INOX 0,35
				0.50	24	8,600 – 15,000	20,000	1	43313006	POS KBG 10013/M14 INOX 0,50
115	15	26	M14x2	0.35	24	6,000 – 12,500	15,000	1	43315003	POS KBG 11515/M14 INOX 0,35
125	15	19	M14x2	0.35	28	6,000 – 12,500	15,000	1	43317003	POS KBG 12515/M14 INOX 0,35
				0.50	28	6,000 – 12,500	15,000	1	43317007	POS KBG 12515/M14 INOX 0,50

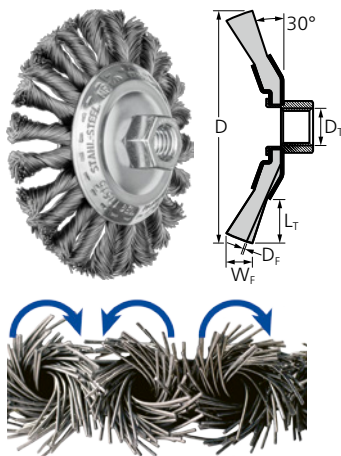

KBG CT, COMBITWIST

Very aggressive brush. Excellent for heavy-duty brushing such as deburring, cleaning, derusting and descaling and removal of spatter. Suitable for work on corners and edges as the knots are less likely to unravel.



Special features:

- Optimal access to hard-to-reach areas such as inner edges, grooves and keyways.
- Maximum economic efficiency due to maximum tool life and stock removal rate and high level of comfort thanks to smooth running with no brush recoiling.
- Aggressive brushing effect due to the very stiff wire knots.

D [mm]	W _F [mm]	L _T [mm]	D _T	D _F [mm]	Knots	Opt. RPM	Max. RPM		Item no.	Designation
Steel wire (ST)										
100	13	22	M14x2	0.50	24	10,000 – 15,000	20,000	1	43313011	POS KBG 10013/M14 CT ST 0,50
								5	43312920	KBG 10013/M14 CT ST 0,50
115	15	26	M14x2	0.50	24	7,500 – 12,500	15,000	1	43315011	POS KBG 11515/M14 CT ST 0,50
								5	43314020	KBG 11515/M14 CT ST 0,50
125	15	19	M14x2	0.50	28	7,500 – 12,500	15,000	1	43317011	POS KBG 12515/M14 CT ST 0,50

Continued on next page

Threaded bevel brushes

knotted



D [mm]	W _f [mm]	L _T [mm]	D _T	D _f [mm]	Knots	Opt. RPM	Max. RPM		Item no.	Designation
-----------	------------------------	------------------------	----------------	------------------------	-------	----------	-------------	---	----------	-------------

Stainless steel wire (INOX) – All INOX brushes are degreased.

100	13	22	M14x2	0.35	24	8,000 – 15,000	20,000	1	43313013	POS KBG 10013/M14 CT INOX 0,35
				0.50	24	8,000 – 15,000	20,000	1	43313016	POS KBG 10013/M14 CT INOX 0,50
115	15	26	M14x2	0.35	24	6,000 – 12,500	15,000	1	43315013	POS KBG 11515/M14 CT INOX 0,35
125	15	19	M14x2	0.35	28	6,000 – 12,500	15,000	1	43317013	POS KBG 12515/M14 CT INOX 0,35



Wheel brushes

crimped

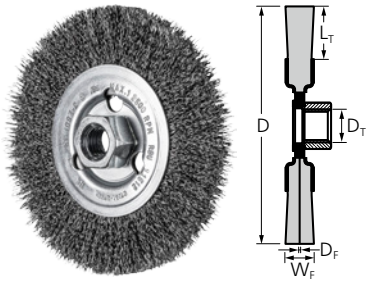

RBU, for angle grinders

Suitable for medium-duty brushing such as derusting, cleaning of weld seams and light deburring work. Can be used on angle grinders up to 80 m/s.



Special features:

- Highly flexible, enabling optimal adjustment to the workpiece contour.
- Creates fine surfaces.

D [mm]	W _F [mm]	L _T [mm]	D _T	D _F [mm]	Opt. RPM	Max. RPM		Item no.	Designation
--------	---------------------	---------------------	----------------	---------------------	----------	----------	--	----------	-------------

Steel wire (ST)

115	12	25	M14x2	0.30	6,300 – 12,500	12,500	1	43502201	POS RBU 11512/M14 ST 0,30
125	12	15	M14x2	0.30	5,500 – 11,000	11,000	1	43502301	POS RBU 12512/M14 ST 0,30

Stainless steel wire (INOX) – All INOX brushes are degreased.

115	12	25	M14x2	0.30	5,000 – 12,500	12,500	1	43502202	POS RBU 11512/M14 INOX 0,30
125	12	15	M14x2	0.30	4,400 – 11,000	11,000	1	43502302	POS RBU 12512/M14 INOX 0,30

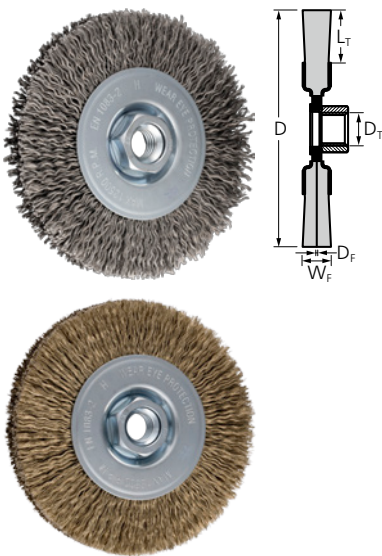

RBU, with cord wire

Suitable for medium-duty brushing such as derusting, cleaning of weld seams and light deburring work. Brushes with cord wire are particularly robust and durable and are therefore ideally suited to demanding tasks. Cord wire is made of multiple wavy wires which are stranded together. This special wire construction combines the aggressive brushing effect of a knotted brush with the flexibility of a wavy brush, achieving an excellent surface finish and a longer tool life.

Special features:

- Highly flexible, enabling optimal adjustment to the workpiece contour.
- Aggressive and effective work due to the special wire construction.
- Longer tool life compared to conventional crimped brushes.

D [mm]	W _F [mm]	L _T [mm]	D _T	D _F [mm]	Opt. RPM	Max. RPM		Item no.	Designation
--------	---------------------	---------------------	----------------	---------------------	----------	----------	--	----------	-------------

Brass-plated steel cord wire (LIT STM)

115	15	25	M14x2	0.20	6,300 – 12,500	12,500	1	43502203	POS RBU 11515/M14 LIT STM 0,20
125	15	29	M14x2	0.20	5,500 – 12,500	12,500	1	43502303	POS RBU 12515/M14 LIT STM 0,20

Stainless steel wire (INOX) – LIT INOX = stranded INOX wire

115	15	25	M14x2	0.30	5,000 – 12,500	12,500	1	43502204	POS RBU 11515/M14 LIT INOX 0,30
125	15	29	M14x2	0.30	4,400 – 12,500	12,500	1	43502304	POS RBU 12515/M14 LIT INOX 0,30

Wheel brushes

crimped

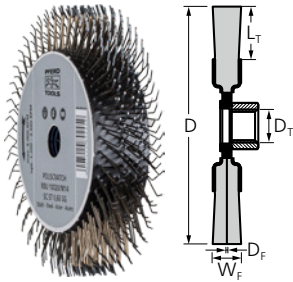

RBU, POLISCRATCH

Excellent for processing and removing soft materials such as underseal and anti-drumming compound. Most suitable for achieving rough surfaces with a sandblasted appearance due to the specific geometry of the filament material.



Special features:

- High cooling effect and no smearing or loading of the brush due to the open construction of the filament material.
- Longer tool life as the brush can be re-sharpened using a sharpening block.
- Use only on speed-adjustable angle and straight grinders.

D [mm]	W _F [mm]	L _T [mm]	D _T	D _F [mm]	Opt. RPM	Max. RPM		Item no.	Designation
Steel wire (ST)									
100	20	18	M14x2	0.60	1,200 – 3,500	6,000	5	43502102	POS RBU 10020/M14 SC ST 0,60

knotted

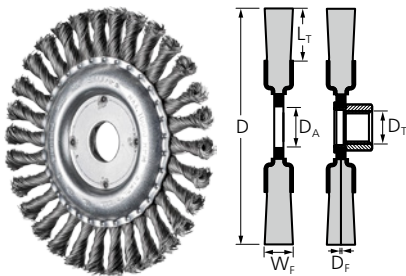

RBG

Aggressive brush. Suitable for heavy-duty brushing in metalwork such as descaling, derusting, deburring, cleaning of weld seams, removal of adhesive residues and spatter.



Special features:

- Aggressive brushing effect due to the very stiff wire knots.

D [mm]	W _F [mm]	L _T [mm]	D _A / D _T	D _F [mm]	Knots	Opt. RPM	Max. RPM		Item no.	Designation
Steel wire (ST)										
100	12	28	M14x2	0.50	22	10,000 – 15,000	20,000	1	43302000	POS RBG 10012/M14 ST 0,50
115	12	22	22.2	0.50	24	6,300 – 12,500	12,500	1	43312001	POS RBG 11512/22,2 ST 0,50
								10	43302120	RBG 11512/22,2 ST 0,50
			M14x2	0.50	24	6,300 – 12,500	12,500	1	43312002	POS RBG 11512/M14 ST 0,50
								1	43312031	POS RBG 11512/X-LOCK ST 0,50
125	12	28	22.2	0.50	24	5,500 – 12,500	12,500	1	43303005	POS RBG 12512/22,2 ST 0,50
								10	43303020	RBG 12512/22,2 ST 0,50
			M14x2	0.50	24	5,500 – 12,500	12,500	1	43303013	POS RBG 12512/M14 ST 0,50
								1	43303035	POS RBG 12512/X-LOCK ST 0,50
150	13	26	22.2	0.60	30	5,000 – 10,000	10,000	1	43309015	POS RBG 15013/22,2 ST 0,60
178	13	38	22.2	0.50	30	4,500 – 8,500	9,000	1	43304001	POS RBG 17813/22,2 ST 0,50
								10	43304020	RBG 17813/22,2 ST 0,50
			0.80	30	4,500 – 8,500	9,000	1	43304007	POS RBG 17813/22,2 ST 0,80	
M14x2	0.50	30	4,500 – 8,500	9,000	1	43304009	POS RBG 17813/M14 ST 0,50			

Continued on next page

D [mm]	W _F [mm]	L _T [mm]	D _A / D _T	D _F [mm]	Knots	Opt. RPM	Max. RPM		Item no.	Designation		
Stainless steel wire (INOX) – All INOX brushes are degreased.												
115	12	22	22.2	0.35	24	5,000 – 12,500	12,500	1	43312003	POS RBG 11512/22,2 INOX 0,35		
									10	43302122	RBG 11512/22,2 INOX 0,35	
				M14x2	0.50	24	5,000 – 12,500	12,500	1	43312006	10	43312006
			43302124									RBG 11512/22,2 INOX 0,50
			X-LOCK		0.50	24	5,000 – 12,500	12,500	1	43312008	1	43312004
				43312008								POS RBG 11512/M14 INOX 0,50
125	12	28	22.2	0.35	24	4,400 – 12,500	12,500	1	43312036	POS RBG 11512/X-LOCK INOX 0,50		
									0.50	24	4,400 – 12,500	12,500
				M14x2	0.50	24	4,400 – 12,500	12,500				
			0.35						24	4,400 – 12,500	12,500	1
					0.50	24	4,400 – 12,500	12,500				
			X-LOCK	0.35					24	4,400 – 12,500	12,500	1
0.50	24	4,400 – 12,500			12,500	1	43303009	1				
				0.50					24	5,000 – 12,500	12,500	1
178	13	38	22.2		0.35	30	3,600 – 8,500	9,000				
				0.50					30	3,600 – 8,500	9,000	1
					M14x2	0.35	30	3,600 – 8,500				
			0.50	30					3,600 – 8,500	9,000	1	43304024
						0.35	30	3,600 – 8,500				
			0.50	30	3,600 – 8,500				9,000	1	43304012	1

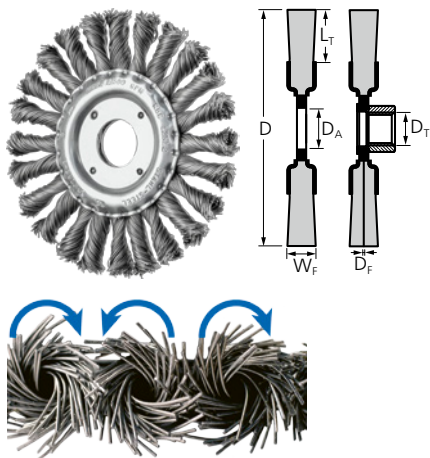

RBG CT, COMBITWIST

Very aggressive brush. Suitable for heavy-duty brushing in metalwork such as descaling, derusting, deburring, cleaning of weld seams and removal of adhesive residues and spatter. Suitable for work on corners and edges as the knots are less likely to unravel.



Special features:

- Maximum economic efficiency due to maximum tool life and stock removal rate.
- High level of comfort thanks to smooth running with no brush recoiling.
- Aggressive brushing effect due to the very stiff wire knots.

D [mm]	W _F [mm]	L _T [mm]	D _A / D _T	D _F [mm]	Knots	Opt. RPM	Max. RPM		Item no.	Designation		
Steel wire (ST)												
115	12	22	22.2	0.50	24	6,300 – 12,500	12,500	1	43312011	POS RBG 11512/22,2 CT ST 0,50		
									10	43302140	RBG 11512/22,2 CT ST 0,50	
			M14x2	0.50	24	6,300 – 12,500	12,500	1	43302131	1	43302131	POS RBG 11512/M14 CT ST 0,50
125	12	28									22.2	0.50
			M14x2	0.50	24	5,500 – 12,500	12,500	1	43303070	1		
178	13	38									22.2	0.50
			0.50	30	4,500 – 8,500	9,000	1	43304011	10	43304011		
0.80	30	4,500 – 8,500								9,000	1	43304040
			0.80	30	4,500 – 8,500	9,000	1	43304017	1			

Continued on next page

D [mm]	W _F [mm]	L _T [mm]	D _A / D _T	D _F [mm]	Knots	Opt. RPM	Max. RPM		Item no.	Designation	
Stainless steel wire (INOX) – All INOX brushes are degreased.											
115	12	22	22.2	0.35	24	5,000 – 12,500	12,500	1	43312013	POS RBG 11512/22,2 CT INOX 0,35	
									10	43302142	RBG 11512/22,2 CT INOX 0,35
									1	43312015	POS RBG 11512/22,2 CT INOX 0,50
			M14x2	0.35	24	5,000 – 12,500	12,500	1	43302133	POS RBG 11512/M14 CT INOX 0,35	
									1	43302135	POS RBG 11512/M14 CT INOX 0,50
125	12	28	22.2	0.35	24	4,400 – 12,500	12,500	1	43303011	POS RBG 12512/22,2 CT INOX 0,35	
									10	43303072	RBG 12512/22,2 CT INOX 0,35
									1	43303012	POS RBG 12512/22,2 CT INOX 0,50
									10	43303074	RBG 12512/22,2 CT INOX 0,50
			M14x2	0.35	24	4,400 – 12,500	12,500	1	43303053	POS RBG 12512/M14 CT INOX 0,35	
									1	43303055	POS RBG 12512/M14 CT INOX 0,50
									1	43304013	POS RBG 12512/M14 CT INOX 0,50
178	13	38	22.2	0.35	30	3,600 – 8,500	9,000	1	43304013	POS RBG 17813/22,2 CT INOX 0,35	
									1	43304018	POS RBG 17813/22,2 CT INOX 0,50
									10	43304046	RBG 17813/22,2 CT INOX 0,50

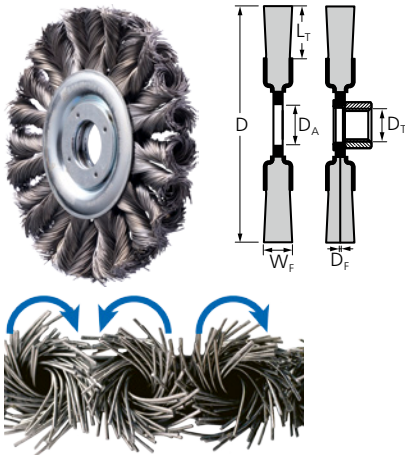

RBG CT HD, COMBITWIST

With a higher filament density and more wire filament, the tool life is at least three times longer and stock removal is improved. Suitable for heavy-duty brushing in metalwork such as descaling, derusting, deburring, cleaning of weld seams and removal of adhesive residues and spatter.

Special features:

- Extremely high filament density for optimum tool life.
- High level of comfort thanks to smooth running with no brush recoiling on corners and edges.
- Aggressive brushing effect due to the very stiff wire knots.

D [mm]	W _F [mm]	L _T [mm]	D _A / D _T	D _F [mm]	Knots	Opt. RPM	Max. RPM		Item no.	Designation
Steel wire (ST)										
115	12	22	22.2	0.50	24	6,300 – 12,500	12,500	1	43312009	POS RBG 11512/22.2 CT ST 0.50 HD
			M14x2	0.50	24	6,300 – 12,500	12,500	1	43312007	POS RBG 11512/M14 CT ST 0.50 HD
125	12	28	22.2	0.50	24	5,500 – 12,500	12,500	1	43303016	POS RBG 12512/22.2 CT ST 0.50 HD
			M14x2	0.50	24	5,500 – 12,500	12,500	1	43303015	POS RBG 12512/M14 CT ST 0.50 HD
150	13	28	22.2	0.50	30	5,000 – 10,000	10,000	1	43317031	POS RBG 15013/22.2 CT ST 0.50 HD
			M14x2	0.50	30	5,000 – 10,000	10,000	1	43317030	POS RBG 15013/M14 CT ST 0.50 HD
178	13	41	22.2	0.50	30	4,500 – 8,500	9,000	1	43317037	POS RBG 17813/22.2 CT ST 0.50 HD
			M14x2	0.50	30	4,500 – 8,500	9,000	1	43317036	POS RBG 17813/M14 CT ST 0.50 HD

Stainless steel wire (INOX) – All INOX brushes are degreased.

115	12	22	22.2	0.35	24	5,000 – 12,500	12,500	1	43312012	POS RBG 11512/22.2 CT INOX 0.35 HD
			M14x2	0.35	24	5,000 – 12,500	12,500	1	43312010	POS RBG 11512/M14 CT INOX 0.35 HD
125	12	28	22.2	0.35	24	4,400 – 12,500	12,500	1	43303018	POS RBG 12512/22.2 CT INOX 0.35 HD
			M14x2	0.35	24	4,400 – 12,500	12,500	1	43303017	POS RBG 12512/M14 CT INOX 0.35 HD
150	13	28	22.2	0.35	30	4,000 – 10,000	10,000	1	43317034	POS RBG 15013/22.2 CT INOX 0.35 HD
			M14x2	0.35	30	4,000 – 10,000	10,000	1	43317033	POS RBG 15013/M14 CT INOX 0.35 HD
178	13	41	22.2	0.35	30	3,600 – 8,500	9,000	1	43317040	POS RBG 17813/22.2 CT INOX 0.35 HD
			M14x2	0.35	30	3,600 – 8,500	9,000	1	43317039	POS RBG 17813/M14 CT INOX 0.35 HD

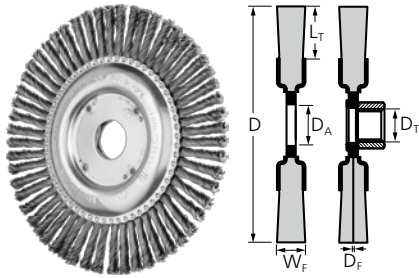

RBG PIPE, Pipeline

Aggressive and robust brush that is able to withstand high mechanical loads. Perfect for heavy-duty brushing in pipeline and container construction.



Special features:

- Extra-slim design enables optimal access to hard-to-reach areas such as root weld seams.
- Aggressive brushing effect due to the very stiff wire knots.

D [mm]	W _F [mm]	L _T [mm]	D _A / D _T	D _F [mm]	Knots	Opt. RPM	Max. RPM		Item no.	Designation
Steel wire (ST)										
100	6	19	16	0.50	32	10,000 – 15,000	20,000	10	43301001	RBG 10006/16,0 PIPE ST 0,50
115	6	21	22.2	0.50	36	6,300 – 12,500	12,500	10	43302101	RBG 11506/22,2 PIPE ST 0,50
			M14x2	0.50	36	6,300 – 12,500	12,500	10	43302102	RBG 11506/M14 PIPE ST 0,50
			X-LOCK	0.50	32	6,300 – 12,500	12,500	1	43302111	POS RBG 11506/X-LOCK PIPE ST 0,50
125	6	18	22.2	0.50	48	6,300 – 12,500	12,500	10	43302501	RBG 12506/22,2 PIPE ST 0,50
			M14x2	0.50	48	6,300 – 12,500	12,500	10	43302502	RBG 12506/M14 PIPE ST 0,50
			X-LOCK	0.50	38	6,300 – 12,500	12,500	1	43302521	POS RBG 12506/X-LOCK PIPE ST 0,50
150	6	27	22.2	0.50	56	5,000 – 10,000	10,000	10	43303501	RBG 15006/22,2 PIPE ST 0,50
			M14x2	0.50	56	5,000 – 10,000	10,000	10	43303502	RBG 15006/M14 PIPE ST 0,50
178	6	28	22.2	0.50	56	4,500 – 8,500	9,000	10	43303801	RBG 17806/22,2 PIPE ST 0,50 56Z
				0.50	76	4,500 – 8,500	9,000	10	43303804	RBG 17806/22,2 PIPE ST 0,50 76Z
			M14x2	0.50	76	4,500 – 8,500	9,000	10	43303805	RBG 17806/M14 PIPE ST 0,50 76Z

Stainless steel wire (INOX) – All INOX brushes are degreased.

100	6	19	16	0.50	32	8,000 – 15,000	20,000	10	43301006	RBG 10006/16,0 PIPE INOX 0,50
115	6	21	22.2	0.50	36	5,000 – 12,500	12,500	10	43302106	RBG 11506/22,2 PIPE INOX 0,50
			M14x2	0.50	36	5,000 – 12,500	12,500	10	43302107	RBG 11506/M14 PIPE INOX 0,50
125	6	18	22.2	0.50	48	5,000 – 12,500	12,500	10	43302506	RBG 12506/22,2 PIPE INOX 0,50
			M14x2	0.50	48	5,000 – 12,500	12,500	10	43302507	RBG 12506/M14 PIPE INOX 0,50
150	6	27	22.2	0.50	56	4,000 – 10,000	10,000	10	43303506	RBG 15006/22,2 PIPE INOX 0,50
			M14x2	0.50	56	4,000 – 10,000	10,000	10	43303507	RBG 15006/M14 PIPE INOX 0,50
178	6	28	22.2	0.50	76	3,600 – 8,500	9,000	10	43303816	RBG 17806/22,2 PIPE INOX 0,50 76Z
			M14x2	0.50	76	3,600 – 8,500	9,000	10	43303817	RBG 17806/M14 PIPE INOX 0,50 76Z

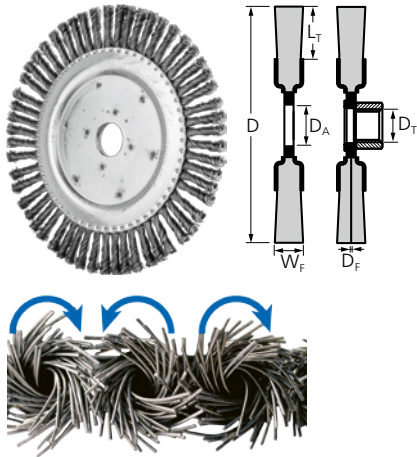

RBG PIPE CT, Pipeline COMBITWIST

Very aggressive and robust brush that is able to withstand high mechanical loads. Perfect for heavy-duty brushing in pipeline and container construction. Suitable for work on corners and edges as the knots are less likely to unravel.

Special features:

- Extra-slim design enables optimal access to hard-to-reach areas such as root weld seams.
- Maximum economic efficiency due to maximum tool life and stock removal rate. High level of comfort thanks to smooth running with no brush recoiling.
- Aggressive brushing effect due to the very stiff wire knots.

D [mm]	W _F [mm]	L _T [mm]	D _A / D _T	D _F [mm]	Knots	Opt. RPM	Max. RPM		Item no.	Designation
Steel wire (ST)										
125	6	18	22.2	0.50	48	6,300 – 12,500	12,500	10	43302504	RBG 12506/22,2 PIPE CT ST 0,50
178	6	28	22.2	0.50	72	4,500 – 8,500	9,000	10	43303810	RBG 17806/22,2 PIPE CT ST 0,50 72Z

knotted, stationary

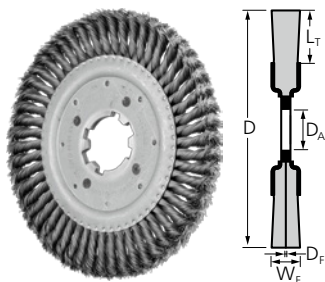

RBG, stationary

Aggressive and robust brush that is able to withstand high mechanical loads. Suitable for all heavy-duty stationary and automated brushing, e.g. deburring work.



Special features:

- Aggressive brushing effect due to the very stiff wire knots.
- Can be used with all commercially available stationary drive systems and bench grinders thanks to the variable hole diameter.

D [mm]	W _F [mm]	L _T [mm]	D _A [mm]	D _F [mm]	Knots	Opt. RPM	Max. RPM		Item no.	Designation
Steel wire (ST)										
200	16	44	50.8	0.50	34	4,000 – 6,500	8,500	1	43310015	RBG 20016/50,8 ST 0,50
250	16	41	50.8	0.35	54	2,000 – 3,400	4,500	1	43310510	RBG 25016/50,8 ST 0,35
				0.50	54	2,000 – 3,400	4,500	1	43310515	RBG 25016/50,8 ST 0,50

Wheel brushes

knotted, stationary

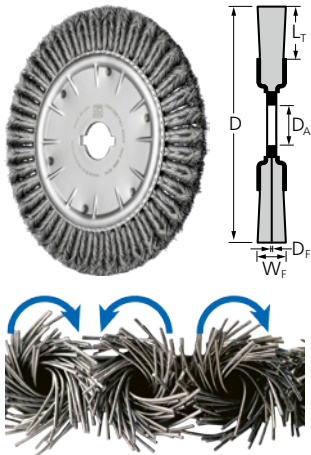

RBG, CT, COMBITWIST stationary

Aggressive and robust brush that is able to withstand high mechanical loads. Suitable for all heavy-duty stationary and automated brushing, e.g. deburring work. Suitable for work on corners and edges as the knots are less likely to unravel.

Special features:

- Maximum economic efficiency due to maximum tool life and stock removal rate. High level of comfort thanks to smooth running with no brush recoiling.
- Aggressive brushing effect due to the very stiff wire knots.
- Can be used with all commercially available stationary drive systems and bench grinders thanks to the variable hole diameter.

D [mm]	W _F [mm]	L _T [mm]	D _A [mm]	D _F [mm]	Knots	Opt. RPM	Max. RPM		Item no.	Designation
Steel wire (ST)										
350	20	56	50.8	0.50	80	700 – 3,000	3,600	1	79182019	RBG 35020/50,8 CT ST 0,50
380	20	67	50.8	0.50	80	700 – 3,000	3,600	1	79182020	RBG 38020/50,8 CT ST 0,50

crimped, with hole

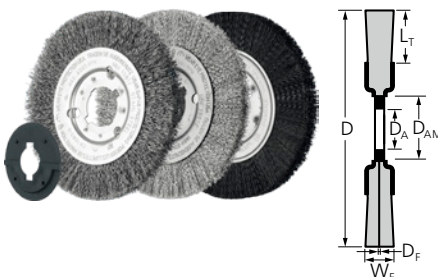

RBU, slim

Excellent for medium-duty hand-held or automated brushing of workpieces with large surfaces.

Special features:

- Can be used with all commercially available stationary drive systems and bench grinders thanks to the variable hole diameter.
- The special design enables bunching to create wide gapless rollers. This enables a uniform surface finish to be achieved.
- Highly flexible, enabling optimal adjustment to the workpiece contour.

D [mm]	W _F [mm]	L _T [mm]	D _A [mm]	D _{AM} [mm]	Grit size	D _F [mm]	Opt. RPM	Max. RPM		Item no.	Designation
Steel wire (ST)											
100	12	24	14	-	-	0.15	4,000 – 6,000	8,000	2	43502005	RBU 10012/14,0 ST 0,15
						0.30	4,000 – 6,000	8,000	2	43502009	RBU 10012/14,0 ST 0,30
125	12	32	14	-	-	0.30	4,000 – 6,000	8,000	2	43503001	RBU 12512/14,0 ST 0,30
150	12	28	22.2	31.8	-	0.25	3,000 – 4,500	6,000	2	43505005	RBU 15012/22,2 ST 0,25
180	12	43	22.2	31.8	-	0.30	3,000 – 4,500	6,000	2	43505201	RBU 18012/22,2 ST 0,30
200	16	44	22.2	31.8	-	0.25	3,000 – 4,500	6,000	2	43506005	RBU 20016/22,2 ST 0,25
250	20	70	22.2	31.8	-	0.25	1,800 – 2,700	3,600	2	43506505	RBU 25020/22,2 ST 0,25

Stainless steel wire (INOX) – All INOX brushes are degreased.

125	12	32	14	-	-	0.30	3,200 – 5,200	8,000	2	43503003	RBU 12512/14,0 INOX 0,30
150	12	28	22.2	31.8	-	0.30	2,400 – 3,900	6,000	2	43505006	RBU 15012/22,2 INOX 0,30
180	12	43	22.2	31.8	-	0.30	2,400 – 3,900	6,000	2	43505202	RBU 18012/22,2 INOX 0,30
200	16	44	22.2	31.8	-	0.30	2,400 – 3,900	6,000	2	43506010	RBU 20016/22,2 INOX 0,30
250	20	70	22.2	31.8	-	0.30	1,400 – 2,300	3,600	2	43506506	RBU 25020/22,2 INOX 0,30

Continued on next page

D [mm]	W _F [mm]	L _T [mm]	D _A [mm]	D _{AM} [mm]	Grit size	D _F [mm]	Opt. RPM	Max. RPM		Item no.	Designation
-----------	------------------------	------------------------	------------------------	-------------------------	--------------	------------------------	----------	-------------	--	----------	-------------

Silicon carbide (SiC) plastic filament

100	12	22	12	-	80	1.10	3,200 – 5,200	8,000	2	43502012	RBU 10012/12,0 SiC 80 1,00
					180	0.90	3,200 – 5,200	8,000	2	43502004	RBU 10012/12,0 SiC 180 0,90
150	16	32	12	31.8	80	1.10	2,400 – 3,900	8,000	2	43505008	RBU 15016/12,0 SiC 80 1,00
					180	0.90	2,400 – 3,900	8,000	2	43505004	RBU 15016/12,0 SiC 180 0,90
200	16	32	22.2	31.8	80	1.10	1,800 – 2,900	4,500	2	43506007	RBU 20016/22,2 SiC 80 1,00
					180	0.90	1,800 – 2,900	4,500	2	43506004	RBU 20016/22,2 SiC 180 0,90
250	16	38	22.2	31.8	80	1.10	1,400 – 2,300	3,600	2	43506508	RBU 25016/22,2 SiC 80 1,00
					180	0.90	1,400 – 2,300	3,600	2	43506504	RBU 25016/22,2 SiC 180 0,90

Ceramic oxide grain (CO) plastic filament

150	16	28	12	31.8	120	1.10	2,400 – 3,900	6,000	2	43505009	RBU 15016/12,0 CO 120 1,10
200	16	38	22.2	31.8	120	1.10	1,800 – 2,900	4,500	2	43506011	RBU 20016/22,2 CO 120 1,10

Nylon plastic filament

100	12	22	12	-	-	0.40	3,200 – 5,200	8,000	2	43502027	RBU 10012/12,0 Nylon 0,40
-----	----	----	----	---	---	------	---------------	-------	---	----------	---------------------------

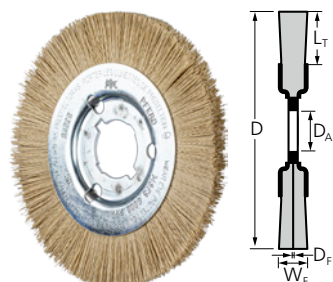

RBU, slim DIA

Brushes with diamond (DIA) filament material are suitable for applications that place particular demands on the aggressiveness of the brush. Excellent for hand-held or automated brushing of workpieces with large surfaces.

Special features:

- Can be used with all commercially available stationary drive systems and bench grinders thanks to the variable hole diameter.
- The special design enables bunching to create wide gapless rollers. This enables a uniform surface finish to be achieved.
- Highly flexible, enabling optimal adjustment to the workpiece contour.

D [mm]	W _F [mm]	L _T [mm]	D _A [mm]	Grit size	D _F [mm]	Opt. RPM	Max. RPM		Item no.	Designation
-----------	------------------------	------------------------	------------------------	--------------	------------------------	----------	-------------	--	----------	-------------

Diamond (DIA) plastic filament

100	12	19	16	600	0.35	2,000 – 5,000	12,000	1	43317017	RBU 10012/16,0 DIA 600 0,35
150	13	28	31.8	600	0.35	1,000 – 3,500	6,000	1	79184323	RBU 15012/31,8 DIA 600 0,35
200	13	38	50.8	600	0.35	900 – 1,500	4,500	1	79184322	RBU 20012/50,8 DIA 600 0,35

Wheel brushes

crimped, with hole

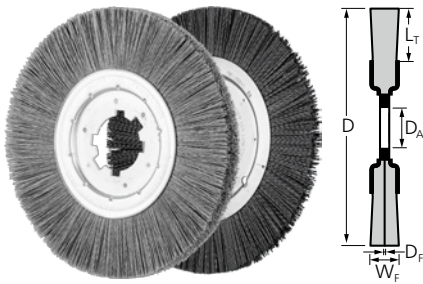

RBU, slim, stationary

Ideal for processing aluminium due to the longer trim length and higher degree of flexibility. Suitable for use on stationary machines, automated centres and robots.



Special features:

- The special design enables bunching to create wide gapless rollers. This enables a uniform surface finish to be achieved.
- Highly flexible, enabling optimal adjustment to the workpiece contour.

D [mm]	W _F [mm]	L _T [mm]	Grit size	D _F [mm]	Opt. RPM	Max. RPM		Item no.	Designation
--------	---------------------	---------------------	-----------	---------------------	----------	----------	--	----------	-------------

Silicon carbide (SiC) plastic filament

200	13	43	120	0.55	2,400 – 3,900	6,000	1	43505904	RBU 20013/50,8 SiC 120 0,55
			180	0.90	2,400 – 3,900	6,000	1	43505914	RBU 20013/50,8 SiC 180 0,90
			320	0.55	2,400 – 3,900	6,000	1	43505924	RBU 20013/50,8 SiC 320 0,55
250	15	55	120	0.55	1,400 – 2,300	3,600	1	43506514	RBU 25015/50,8 SiC 120 0,55
			180	0.90	1,400 – 2,300	3,600	1	43506524	RBU 25015/50,8 SiC 180 0,90
			320	0.55	1,400 – 2,300	3,600	1	43506534	RBU 25015/50,8 SiC 320 0,55

Ceramic oxide grain (CO) plastic filament

200	13	46	120	1.10	2,400 – 3,900	6,000	1	43505930	RBU 20013/50,8 CO 120 1,10
250	15	63	120	1.10	1,400 – 2,300	3,600	1	43506540	RBU 25015/50,8 CO 120 1,10

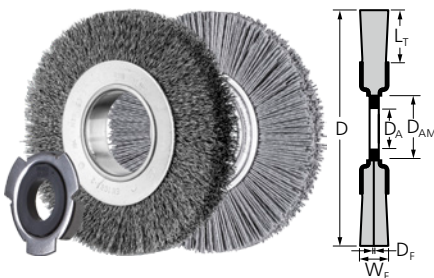

RBU, wide, universal use

Excellent for medium-duty hand-held or automated brushing of workpieces with large surfaces. Developed for general use in the workshop.



Special features:

- Can be used with all commercially available stationary drive systems and bench grinders thanks to the variable hole diameter.
- Highly flexible, enabling optimal adjustment to the workpiece contour.

D [mm]	W _F [mm]	L _T [mm]	D _A [mm]	D _{AM} [mm]	Grit size	D _F [mm]	Opt. RPM	Max. RPM		Item no.	Designation
--------	---------------------	---------------------	---------------------	----------------------	-----------	---------------------	----------	----------	--	----------	-------------

Steel wire (ST)

80	20	20	10/12/14	20	-	0.15	5,000 – 7,500	10,000	1	43701103	POS RBU 8020/20 ST 0,15
					-	0.20	5,000 – 7,500	10,000	1	43701104	POS RBU 8020/20 ST 0,20
100	20	25	12/14/18/22.2/25.4	30	-	0.30	4,000 – 6,000	8,000	1	43701105	POS RBU 10020/14,0 ST 0,30
	28	25	12/14/18/22.2/25.4	30	-	0.30	4,000 – 6,000	8,000	1	43701109	POS RBU 10028/14,0 ST 0,30
125	20	30	12/14/18/22.2/25.4	30	-	0.30	3,000 – 4,500	6,000	1	43701115	POS RBU 12520/14,0 ST 0,30
	28	30	12/14/18/22.2/25.4	30	-	0.30	3,000 – 4,500	6,000	1	43701119	POS RBU 12528/14,0 ST 0,30
150	25	25	AK 32-2	50.8	-	0.20	3,000 – 4,500	6,000	1	43701205	POS RBU 15025/AK32-2 ST 0,20
					-	0.30	3,000 – 4,500	6,000	1	43701209	POS RBU 15025/AK32-2 ST 0,30
	38	25	AK 32-2	50.8	-	0.20	3,000 – 4,500	6,000	1	43701213	POS RBU 15038/AK32-2 ST 0,20

Continued on next page

Wheel brushes

crimped, with hole



D [mm]	W _F [mm]	L _T [mm]	D _A [mm]	D _{AM} [mm]	Grit size	D _F [mm]	Opt. RPM	Max. RPM		Item no.	Designation
150	38	25	AK 32-2	50.8	-	0.30	3,000 – 4,500	6,000	1	43701217	POS RBU 15038/AK32-2 ST 0,30
180	25	40	AK 32-2	50.8	-	0.20	3,000 – 4,500	6,000	1	43701235	POS RBU 18025/AK32-2 ST 0,20
						0.30	3,000 – 4,500	6,000	1	43701239	POS RBU 18025/AK32-2 ST 0,30
200	38	40	AK 32-2	50.8	-	0.30	3,000 – 4,500	6,000	1	43701245	POS RBU 18038/AK32-2 ST 0,30
	25	50	AK 32-2	50.8	-	0.20	2,300 – 3,400	4,500	1	43701255	POS RBU 20025/AK32-2 ST 0,20
						0.30	2,300 – 3,400	4,500	1	43701259	POS RBU 20025/AK32-2 ST 0,30
250	30	54	AK 32-2	50.8	-	0.30	2,300 – 3,400	4,500	1	43701265	POS RBU 20038/AK32-2 ST 0,30
						0.20	1,400 – 2,300	3,600	1	43740130	POS RBU 25030/AK32-2 ST 0,20
						0.30	1,400 – 2,300	3,600	1	43740131	POS RBU 25030/AK32-2 ST 0,30

Stainless steel wire (INOX)

80	20	20	10/12/14	20	-	0.15	4,000 – 6,500	10,000	1	43701107	POS RBU 8020/20 INOX 0,15
						0.20	4,000 – 6,500	10,000	1	43701108	POS RBU 8020/20 INOX 0,20
100	20	25	12/14/18/22.2/25.4	30	-	0.30	3,200 – 5,200	8,000	1	43701106	POS RBU 10020/14,0 INOX 0,30
	28	25	12/14/18/22.2/25.4	30	-	0.30	3,200 – 5,200	8,000	1	43701110	POS RBU 10028/14,0 INOX 0,30
125	20	30	12/14/18/22.2/25.4	30	-	0.30	2,400 – 3,900	6,000	1	43701116	POS RBU 12520/14,0 INOX 0,30
	28	30	12/14/18/22.2/25.4	30	-	0.30	2,400 – 3,900	6,000	1	43701120	POS RBU 12528/14,0 INOX 0,30
150	25	25	AK 32-2	50.8	-	0.20	2,400 – 3,900	6,000	1	43701206	POS RBU 15025/AK32-2 INOX 0,20
						0.30	2,400 – 3,900	6,000	1	43701210	POS RBU 15025/AK32-2 INOX 0,30
						0.20	2,400 – 3,900	6,000	1	43701214	POS RBU 15038/AK32-2 INOX 0,20
						0.30	2,400 – 3,900	6,000	1	43701218	POS RBU 15038/AK32-2 INOX 0,30
180	25	40	AK 32-2	50.8	-	0.20	2,400 – 3,900	6,000	1	43701236	POS RBU 18025/AK32-2 INOX 0,20
						0.30	2,400 – 3,900	6,000	1	43701240	POS RBU 18025/AK32-2 INOX 0,30
						0.30	2,400 – 3,900	6,000	1	43701246	POS RBU 18038/AK32-2 INOX 0,30
200	25	50	AK 32-2	50.8	-	0.20	1,800 – 2,900	4,500	1	43701256	POS RBU 20025/AK32-2 INOX 0,20
						0.30	1,800 – 2,900	4,500	1	43701260	POS RBU 20025/AK32-2 INOX 0,30
						0.30	1,800 – 2,900	4,500	1	43701266	POS RBU 20038/AK32-2 INOX 0,30
250	30	54	AK 32-2	50.8	-	0.20	1,400 – 2,300	3,600	1	43740132	POS RBU 25030/AK32-2 INOX 0,20
						0.30	1,400 – 2,300	3,600	1	43740133	POS RBU 25030/AK32-2 INOX 0,30

Silicon carbide (SiC) plastic filament

150	25	35	AK 32-2	50.8	120	0.55	2,400 – 3,900	6,000	1	43701181	POS RBU 15025/AK32-2 SiC 120 0,55
						1.10	2,400 – 3,900	6,000	1	43701182	POS RBU 15025/AK32-2 SiC 120 1,10
						0.55	2,400 – 3,900	6,000	1	43701183	POS RBU 15025/AK32-2 SiC 320 0,55
200	25	50	AK 32-2	50.8	120	1.10	2,400 – 3,900	6,000	1	43701257	POS RBU 20025/AK32-2 SiC 120 1,10
250	30	54	AK 32-2	50.8	120	1.10	1,400 – 2,300	3,600	1	43740134	POS RBU 25030/AK32-2 SiC 120 1,10



Wheel brushes

crimped, with hole

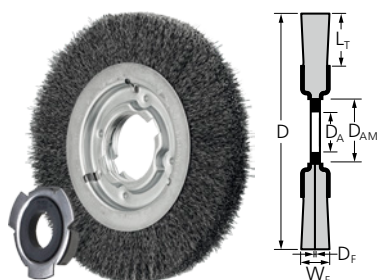

RBU, wide, industrial use

Excellent for medium-duty hand-held or automated brushing of workpieces with large surfaces. Developed specially for industrial use. The brush impresses with its very long tool life, which ensures high economic efficiency.



Special features:

- Can be used with all commercially available stationary drive systems and bench grinders thanks to the variable hole diameter.
- The special design enables bunching to create wide gapless rollers. This enables a uniform surface finish to be achieved.
- Highly flexible, enabling optimal adjustment to the workpiece contour.

D [mm]	W _f [mm]	L _t [mm]	D _A [mm]	D _{AM} [mm]	D _F [mm]	Opt. RPM	Max. RPM		Item no.	Designation
Steel wire (ST)										
100	20	19	14.0/18.0/22.2	25.4	0.30	4,000 – 6,000	8,000	1	43502101	RBU 10020/14,0 ST 0,30
	28	19	14.0/18.0/22.2	25.4	0.30	4,000 – 6,000	8,000	1	43502001	RBU 10028/14,0 ST 0,30
150	25	25	AK 32-2	50.8	0.30	3,000 – 4,500	6,000	1	43505101	RBU 15025/AK32-2 ST 0,30
	38	25	AK 32-2	50.8	0.30	3,000 – 4,500	6,000	1	43505001	RBU 15038/AK32-2 ST 0,30
180	25	40	AK 32-2	50.8	0.30	3,000 – 4,500	6,000	1	43505210	RBU 18025/AK32-2 ST 0,30
200	25	38	AK 32-2	50.8	0.30	2,300 – 3,400	4,500	1	43506101	RBU 20025/AK32-2 ST 0,30
	38	38	AK 32-2	50.8	0.30	2,300 – 3,400	4,500	1	43506001	RBU 20038/AK32-2 ST 0,30
250	30	50	AK 32-2	50.8	0.30	1,800 – 2,700	3,600	1	43506601	RBU 25030/AK32-2 ST 0,30
	48	50	AK 32-2	50.8	0.30	1,800 – 2,700	3,600	1	43506501	RBU 25048/AK32-2 ST 0,30
300	40	40	50.8	117.5	0.30	1,500 – 2,500	3,000	1	43507027	RBU 30040/50,8 ST 0,30

Stainless steel wire (INOX) – All INOX brushes are degreased.

150	25	25	AK 32-2	50.8	0.30	2,400 – 3,900	6,000	1	43505102	RBU 15025/AK32-2 INOX 0,30
	38	25	AK 32-2	50.8	0.30	2,400 – 3,900	6,000	1	43505003	RBU 15038/AK32-2 INOX 0,30
180	25	40	AK 32-2	50.8	0.30	2,400 – 3,900	6,000	1	43505212	RBU 18025/AK32-2 INOX 0,30
200	25	38	AK 32-2	50.8	0.30	1,800 – 2,900	4,500	1	43506102	RBU 20025/AK32-2 INOX 0,30
	38	38	AK 32-2	50.8	0.30	1,800 – 2,900	4,500	1	43506003	RBU 20038/AK32-2 INOX 0,30
250	30	50	AK 32-2	50.8	0.30	1,400 – 2,300	3,600	1	43506603	RBU 25030/AK32-2 INOX 0,30
	48	50	AK 32-2	50.8	0.30	1,400 – 2,300	3,600	1	43506503	RBU 25048/AK32-2 INOX 0,30

Wheel brushes

crimped, with hole

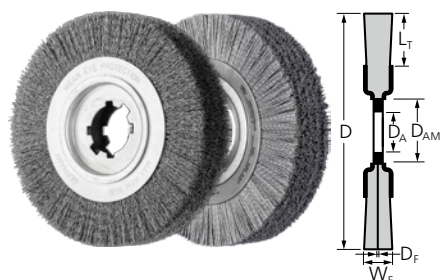

RBU, deburring brushes

Particularly suitable for deburring pipes, cut edges and small parts on stationary machines.

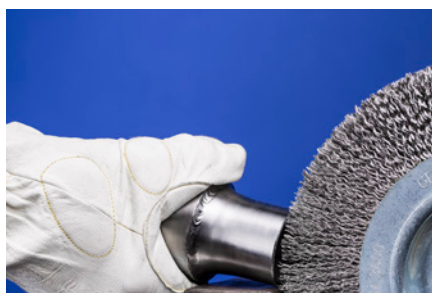

Special features:

- Individual check for imbalance guarantees smooth running.
- Maximum tool life thanks to high filament density.
- Highly flexible, enabling optimal adjustment to the workpiece contour.

D [mm]	W _F [mm]	L _T [mm]	D _A [mm]	D _{AM} [mm]	Grit size	D _F [mm]	Opt. RPM	Max. RPM		Item no.	Designation
Steel wire (ST)											
250	60	50	50.8	100	-	0.20	1,800 – 2,700	3,600	1	43506701	RBU 25060/50,8 ST 0,20
						0.35	1,800 – 2,700	3,600	1	43506711	RBU 25060/50,8 ST 0,35
						0.50	1,800 – 2,700	3,600	1	43506721	RBU 25060/50,8 ST 0,50
	80	50	50.8	100	-	0.35	1,800 – 2,700	3,600	1	43506741	RBU 25080/50,8 ST 0,35
	100	50	50.8	100	-	0.35	1,800 – 2,700	3,600	1	43506811	RBU 250100/50,8 ST 0,35
						0.50	1,800 – 2,700	3,600	1	43506821	RBU 250100/50,8 ST 0,50
Brass-plated steel cord wire (LIT STM)											
250	60	50	50.8	100	-	0.35	1,800 – 2,700	3,600	1	43506716	RBU 25060/50,8 LIT ST 0,35
Stainless steel wire (INOX)											
250	60	50	50.8	100	-	0.20	1,400 – 2,300	3,600	1	43506702	RBU 25060/50,8 INOX 0,20
						0.35	1,400 – 2,300	3,600	1	43506712	RBU 25060/50,8 INOX 0,35
						0.50	1,400 – 2,300	3,600	1	43506722	RBU 25060/50,8 INOX 0,50
	100	50	50.8	100	-	0.35	1,400 – 2,300	3,600	1	43506812	RBU 250100/50,8 INOX 0,35
Silicon carbide (SiC) plastic filament											
250	60	45	50.8	100	120	1.10	1,400 – 2,300	3,600	1	43506724	RBU 25060/50,8 SiC 120 1,10

Composite brushes

Wheel brushes, crimped

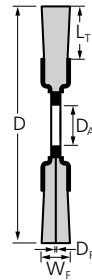

RBUP

Particularly aggressive brush. Its plastic filament makes this product particularly suitable for deburring complicated components such as cylinder heads or gear toothing, as well as for working on surfaces. Developed specially for industrial use.

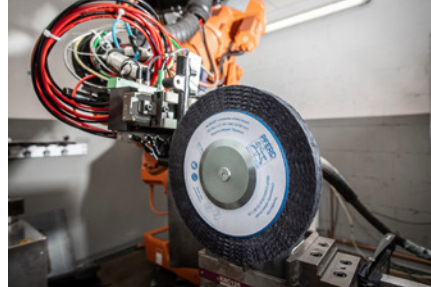

Special features:

- Long tool life and aggressive brushing effect due to a very high filament density.
- Extremely smooth operation due to even distribution of the filament material.

D [mm]	W _F [mm]	L _T [mm]	D _A [mm]	Grit size	D _F [mm]	Opt. RPM	Max. RPM		Item no.	Designation
Silicon carbide (SiC) plastic filament										
150	25	32	50.8	80	1.10	900 – 1,500	3,600	1	79183720	RBUP 15025/50,8 SiC 80 1,10
					1.14	900 – 1,500	3,600	1	79183721	RBUP 15025/50,8 REC SiC 80 1,14
				120	1.10	900 – 1,500	3,600	1	79183722	RBUP 15025/50,8 SiC 120 1,10
				320	0.55	900 – 1,500	3,600	1	79183723	RBUP 15025/50,8 SiC 320 0,55
200	25	32	50.8	80	1.10	900 – 1,500	3,600	1	79183726	RBUP 20025/50,8 SiC 80 1,10
				120	1.10	900 – 1,500	3,600	1	79183728	RBUP 20025/50,8 SiC 120 1,10
				320	0.55	900 – 1,500	3,600	1	79183729	RBUP 20025/50,8 SiC 320 0,55
250	25	38	50.8	80	1.10	900 – 1,500	3,600	1	79183738	RBUP 25025/50,8 SiC 80 1,10
				120	0.55	900 – 1,500	3,600	1	79183742	RBUP 25025/50,8 SiC 120 0,55
					1.10	900 – 1,500	3,600	1	79183740	RBUP 25025/50,8 SiC 120 1,10
				320	0.55	900 – 1,500	3,600	1	79183741	RBUP 25025/50,8 SiC 320 0,55
Ceramic oxide grain (CO) plastic filament										
150	13	32	50.8	80	1.10	900 – 1,500	3,600	1	79184118	RBUP 15013/50,8 CO 80 1,10
				120	1.10	900 – 1,500	3,600	1	79184119	RBUP 15013/50,8 CO 120 1,10
200	25	32	50.8	80	1.10	900 – 1,500	3,600	1	79184165	RBUP 15025/50,8 CO 80 1,10
				120	1.10	900 – 1,500	3,600	1	79184127	RBUP 20013/50,8 CO 80 1,10
					1.10	900 – 1,500	3,600	1	79184132	RBUP 20013/50,8 CO 120 1,10
250	25	32	50.8	80	1.10	900 – 1,500	3,600	1	79184169	RBUP 20025/50,8 CO 80 1,10
				80	1.10	500 – 800	1,800	1	79184173	RBUP 25025/50,8 CO 80 1,10



Composite brushes

Wheel brushes, crimped



RBUP, FLEX

Particularly flexible brush. Its plastic filament makes this product particularly suitable for deburring complicated components such as cylinder heads or gear toothing. Developed specially for industrial use.



Special features:

- Long tool life and aggressive brushing effect due to a very high filament density.
- Extremely smooth operation due to even distribution of the filament material.
- Highly flexible, enabling optimal adjustment to the workpiece contour and less heat build-up.

D [mm]	W _F [mm]	L _T [mm]	D _A [mm]	Grit size	D _F [mm]	Opt. RPM	Max. RPM		Item no.	Designation
--------	---------------------	---------------------	---------------------	-----------	---------------------	----------	----------	---	----------	-------------

Silicon carbide (SiC) plastic filament

200	25	57	50.8	80	1.10	900 – 1,500	3,600	1	79183732	RBUP 20025/50,8 SiC 80 1,10 FLEX	
					1.14	900 – 1,500	3,600	1	79183733	RBUP 20025/50,8 REC SiC 80 1,14 FLEX	
				120	1.10	900 – 1,500	3,600	1	79183734	RBUP 20025/50,8 SiC 120 1,10 FLEX	
					0.55	900 – 1,500	3,600	1	79183735	RBUP 20025/50,8 SiC 320 0,55 FLEX	
250	25	83	50.8	80	1.10	900 – 1,500	3,600	1	79183744	RBUP 25025/50,8 SiC 80 1,10 FLEX	
					1.14	900 – 1,500	3,600	1	79183745	RBUP 25025/50,8 REC SiC 80 1,14 FLEX	
				120	1.10	900 – 1,500	3,600	1	79183746	RBUP 25025/50,8 SiC 120 1,10 FLEX	
					0.90	900 – 1,500	3,600	1	79183657	RBUP 25025/50,8 SiC 180 0,90 FLEX	
300	13	60	50.8	320	0.55	900 – 1,500	3,600	1	79183747	RBUP 25025/50,8 SiC 320 0,55 FLEX	
					80	1.10	500 – 800	1,800	1	79184150	RBUP 30013/50,8 SiC 320 0,55 FLEX
						1.10	500 – 800	1,800	1	79183659	RBUP 30025/50,8 SiC 80 1,10 FLEX
300	25	60	50.8	120	1.10	500 – 800	1,800	1	79183660	RBUP 30025/50,8 SiC 120 1,10 FLEX	
					0.90	500 – 800	1,800	1	79183661	RBUP 30025/50,8 SiC 180 0,90 FLEX	
					180	1.10	500 – 800	1,800	1	79183663	RBUP 35025/50,8 SiC 80 1,10 FLEX
0.90	500 – 800	1,800	1	79183665		RBUP 35025/50,8 SiC 180 0,90 FLEX					

Ceramic oxide grain (CO) plastic filament

200	13	57	50.8	80	1.10	900 – 1,500	3,600	1	79184124	RBUP 20013/50,8 CO 80 1,10 FLEX
					1.10	900 – 1,500	3,600	1	79184126	RBUP 20013/50,8 CO 120 1,10 FLEX
250	13	70	50.8	80	1.10	900 – 1,500	3,600	1	79184133	RBUP 25013/50,8 CO 80 1,10 FLEX
					0.55	900 – 1,500	3,600	1	79184138	RBUP 25013/50,8 CO 120 0,55 FLEX
				120	1.10	900 – 1,500	3,600	1	79184139	RBUP 25013/50,8 CO 120 1,10 FLEX
300	13	60	50.8		80	1.10	500 – 800	1,800	1	79184144
				1.10		500 – 800	1,800	1	79184145	RBUP 30013/50,8 CO 120 1,10 FLEX
				120	80	1.10	500 – 800	1,800	1	79184189
1.10	500 – 800	1,800	1			79184190	RBUP 30025/50,8 CO 120 1,10 FLEX			
350	13	89	50.8	80	1.10	500 – 800	1,800	1	79184151	RBUP 35013/50,8 CO 80 1,10 FLEX
					1.10	500 – 800	1,800	1	79184152	RBUP 35013/50,8 CO 120 1,10 FLEX
	25	89	50.8	80	1.10	500 – 800	1,800	1	79184193	RBUP 35025/50,8 CO 80 1,10 FLEX
					1.10	500 – 800	1,800	1	79184194	RBUP 35025/50,8 CO 120 1,10 FLEX



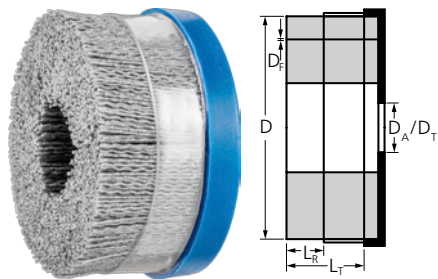

DBUR, with bridle

Particularly aggressive brush. Particularly suitable for deburring and work on surfaces on stationary machines. The bridle prevents the filament spreading out sideways. The bridle enables the spreading out and flexibility of the brush filament to be controlled.



Special features:

- Long tool life and aggressive brushing effect due to a very high filament density.
- Extremely smooth operation due to even distribution of the filament material.
- If the filament has worn away down to the bridle, it can be removed from the bridle for further use. This does not affect the brushing behaviour.

D [mm]	L _r [mm]	L _t [mm]	D _A / D _T	Grit size	D _f [mm]	Opt. RPM	Max. RPM		Item no.	Designation
Silicon carbide (SiC) plastic filament										
75	19	38	22.2	80	1.10	2,400 – 3,900	4,500	1	79184120	DBUR 75/22,2 SiC 80 1,10
					1.14	2,400 – 3,900	4,500	1	79184121	DBUR 75/22,2 REC SiC 80 1,14
				120	1.10	2,400 – 3,900	4,500	1	79184122	DBUR 75/22,2 SiC 120 1,10
				320	0.55	2,400 – 3,900	4,500	1	79184125	DBUR 75/22,2 SiC 320 0,55
			M14x2	80	1.10	2,400 – 3,900	6,000	1	43400004	DBUR 75/M14 SiC 80 1,10
				1.14	2,400 – 3,900	6,000	1	43400003	DBUR 75/M14 REC SiC 80 1,14	
100	19	38	22.2	80	1.10	1,400 – 2,300	3,500	1	79184128	DBUR 100/22,2 SiC 80 1,10
					1.14	1,400 – 2,300	3,500	1	79184129	DBUR 100/22,2 REC SiC 80 1,14
				120	1.10	1,400 – 2,300	3,500	1	79184130	DBUR 100/22,2 SiC 120 1,10
				320	0.55	1,400 – 2,300	3,500	1	79184131	DBUR 100/22,2 SiC 320 0,55
125	19	38	22.2	80	1.10	1,200 – 2,000	3,000	1	79184134	DBUR 125/22,2 SiC 80 1,10
					1.14	1,200 – 2,000	3,000	1	79184135	DBUR 125/22,2 REC SiC 80 1,14
				120	1.10	1,200 – 2,000	3,000	1	79184136	DBUR 125/22,2 SiC 120 1,10
150	19	38	22.2	80	1.10	1,000 – 1,600	2,500	1	79184140	DBUR 150/22,2 SiC 80 1,10
					1.14	1,000 – 1,600	2,500	1	79184141	DBUR 150/22,2 REC SiC 80 1,14
				120	1.10	1,000 – 1,600	2,500	1	79184142	DBUR 150/22,2 SiC 120 1,10

Ceramic oxide grain (CO) plastic filament

75	19	38	22.2	120	1.10	2,400 – 3,900	4,500	1	79184232	DBUR 75/22,2 CO 120 1,10
100	19	38	22.2	120	1.10	1,400 – 2,300	3,500	1	79184237	DBUR 100/22,2 CO 120 1,10
125	19	38	22.2	120	1.10	1,200 – 2,000	3,000	1	43400030	DBUR 125/22,2 CO 120 1,10
150	19	38	22.2	120	1.10	1,000 – 1,600	2,500	1	43400040	DBUR 150/22,2 CO 120 1,10

Composite brushes

Composite disc brushes, crimped

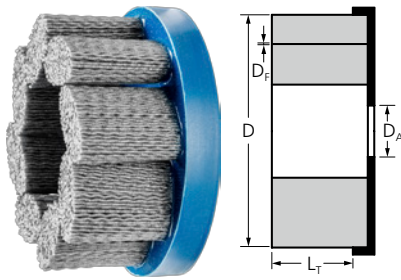

DBU, FLEX

Particularly flexible brush. Particularly suitable for deburring and work on surfaces on stationary machines.

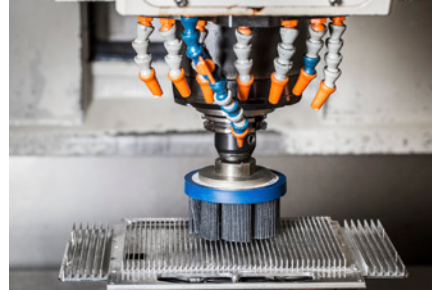

Special features:

- Long tool life and aggressive brushing effect due to a very high filament density.
- Extremely smooth operation due to even distribution of the filament material.
- Special arrangement of the filament enables optimal adjustment to the workpiece contour, less heat build-up and more efficient use of the coolant.

D [mm]	L _T [mm]	D _A [mm]	Grit size	D _f [mm]	Opt. RPM	Max. RPM		Item no.	Designation
--------	---------------------	---------------------	-----------	---------------------	----------	----------	---	----------	-------------

Silicon carbide (SiC) plastic filament

75	38	22.2	80	1.10	2,400 – 3,900	4,500	1	79183941	DBU 75/22,2 SiC 80 1,10 FLEX
				1.14	2,400 – 3,900	4,500	1	79183966	DBU 75/22,2 REC SiC 80 1,14 FLEX
			320	1.10	2,400 – 3,900	4,500	1	79183942	DBU 75/22,2 SiC 120 1,10 FLEX
				0.55	2,400 – 3,900	4,500	1	79183944	DBU 75/22,2 SiC 320 0,55 FLEX
100	38	22.2	80	1.10	1,400 – 2,300	3,500	1	79183945	DBU 100/22,2 SiC 80 1,10 FLEX
				1.14	1,400 – 2,300	3,500	1	79183968	DBU 100/22,2 REC SiC 80 1,14 FLEX
			320	1.10	1,400 – 2,300	3,500	1	79183946	DBU 100/22,2 SiC 120 1,10 FLEX
				0.55	1,400 – 2,300	3,500	1	79183948	DBU 100/22,2 SiC 320 0,55 FLEX
150	38	22.2	80	1.10	1,000 – 1,600	2,500	1	79183949	DBU 150/22,2 SiC 80 1,10 FLEX
				1.14	1,000 – 1,600	2,500	1	79183970	DBU 150/22,2 REC SiC 80 1,14 FLEX
			320	1.10	1,000 – 1,600	2,500	1	79183950	DBU 150/22,2 SiC 120 1,10 FLEX
				0.55	1,000 – 1,600	2,500	1	79183952	DBU 150/22,2 SiC 320 0,55 FLEX

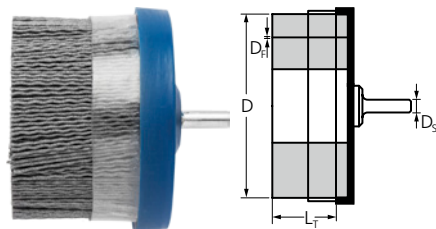

DBUR shank-mounted, with bridle

Particularly aggressive brush. Particularly suitable for deburring and work on surfaces on stationary machines. The bridle prevents the filament spreading out sideways. The bridle enables the spreading out and flexibility of the brush filament to be controlled.

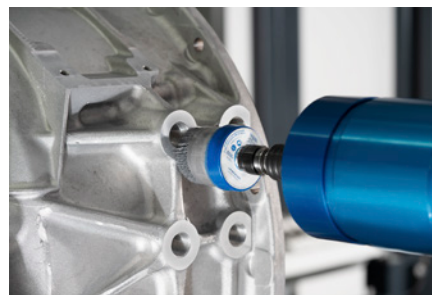

Special features:

- Long tool life and aggressive brushing effect due to a very high filament density.
- Extremely smooth operation due to even distribution of the filament material.
- If the filament has worn away down to the bridle, it can be removed from the bridle for further use. This does not affect the brushing behaviour.

D [mm]	D _s [mm]	L _r [mm]	L _t [mm]	H [mm]	Grit size	D _f [mm]	Opt. RPM	Max. RPM		Item no.	Designation
--------	---------------------	---------------------	---------------------	--------	-----------	---------------------	----------	----------	---	----------	-------------

Silicon carbide (SiC) plastic filament

50	6	19	38	80	120	0.55	1,500 – 3,500	5,000	1	43400041	DBUR 50/6 SiC 120 0,55
						1.10	1,500 – 3,500	5,000	1	43400042	DBUR 50/6 SiC 120 1,00
63	6	19	38	80	120	0.55	1,500 – 3,500	5,000	1	43400043	DBUR 63/6 SiC 120 0,55
						1.10	1,500 – 3,500	5,000	1	43400044	DBUR 63/6 SiC 120 1,00

Ceramic oxide grain (CO) plastic filament

50	6	19	38	80	120	1.10	1,500 – 3,500	5,000	1	43400045	DBUR 50/6 CO 120 1,10
63	6	19	38	80	120	1.10	1,500 – 3,500	5,000	1	43400046	DBUR 63/6 CO 120 1,10

Composite brushes

Shank-mounted end brushes, crimped

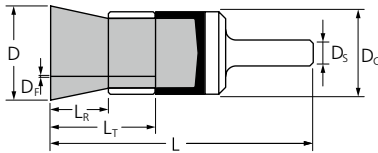

PBUPR, with bridle

Particularly suitable for deburring and work on surfaces on stationary machines. The bridle prevents the wires spreading out sideways. The bridle enables the spreading out and flexibility of the brush filament to be controlled.



Special features:

- Long tool life and aggressive brushing effect due to a very high filament density. Extremely smooth operation due to even distribution of the filament material.
- Optimal access to hard-to-reach areas such as drilled holes and cavities as the filament spreads out upon rotation.
- If the filament has worn away down to the bridle, it can be removed from the bridle for further use. This does not affect the brushing behaviour.

D [mm]	D _c [mm]	D _s [mm]	L _r [mm]	L _t [mm]	L [mm]	Grit size	D _f [mm]	Opt. RPM	Max. RPM		Item no.	Designation
--------	---------------------	---------------------	---------------------	---------------------	--------	-----------	---------------------	----------	----------	---	----------	-------------

Silicon carbide (SiC) plastic filament

25	28	6	13	25	70	120	0.55	2,400 – 3,900	6,000	1	43214121	PBUPR 2528/6 SiC 120 0,55
							1.10	2,400 – 3,900	6,000	1	43214122	PBUPR 2528/6 SiC 120 1,00
38	38	6	13	25	77	120	0.55	2,000 – 3,200	5,000	1	43214131	PBUPR 3838/6 SiC 120 0,55
							1.10	2,000 – 3,200	5,000	1	43214132	PBUPR 3838/6 SiC 120 1,00

Ceramic oxide grain (CO) plastic filament

25	28	6	13	25	70	120	1.10	2,400 – 3,900	6,000	1	43214111	PBUPR 2528/6 CO 120 1,00
38	38	6	13	25	77	120	1.10	2,000 – 3,200	5,000	1	43214112	PBUPR 3838/6 CO 120 1,00

Shank-mounted end brushes

crimped

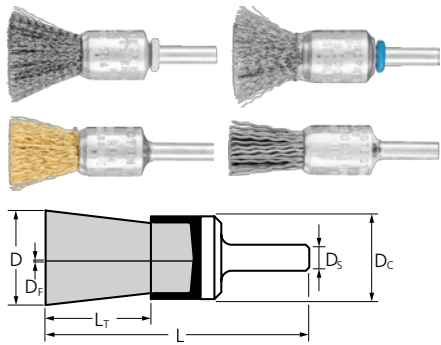

PBU

Suitable for light brushing such as deburring, cleaning and derusting.



Special features:

- Optimal access to hard-to-reach areas such as drilled holes and cavities as the wires spread out upon rotation.
- Creates fine surfaces.

D [mm]	D _C [mm]	D _S [mm]	L _T [mm]	Grit size	D _F [mm]	L [mm]	Opt. RPM	Max. RPM		Item no.	Designation
--------	---------------------	---------------------	---------------------	-----------	---------------------	--------	----------	----------	--	----------	-------------

Steel wire (ST)

10	10	6	20	-	0.20	65	10,000 – 15,000	20,000	10	43204005	PBU 1010/6 ST 0,20
					0.35	65	10,000 – 15,000	20,000	10	43204001	PBU 1010/6 ST 0,35
13	12	6	20	-	0.20	65	10,000 – 15,000	20,000	10	43204105	PBU 1312/6 ST 0,20
					0.35	65	10,000 – 15,000	20,000	10	43204101	PBU 1312/6 ST 0,35
15	16	6	22	-	0.20	65	9,000 – 13,500	18,000	10	43203005	PBU 1516/6 ST 0,20
					0.35	65	9,000 – 13,500	18,000	10	43203001	PBU 1516/6 ST 0,35
20	22	6	25	-	0.20	70	9,000 – 13,500	18,000	10	43704001	POS PBU 1516/6 ST 0,35
										43202005	PBU 2022/6 ST 0,20
										43704013	POS PBU 2022/6 ST 0,20
30	29	6	25	-	0.50	70	9,000 – 13,500	18,000	10	43202001	PBU 2022/6 ST 0,50
										43704005	POS PBU 2022/6 ST 0,50
										43201005	PBU 3029/6 ST 0,20
					0.50	70	7,500 – 11,300	15,000	10	43201001	PBU 3029/6 ST 0,50

Stainless steel wire (INOX) – Supplied with plastic-covered brush body. All INOX brushes are degreased.

10	10	6	20	-	0.15	65	8,000 – 13,000	20,000	10	43204010	PBU 1010/6 INOX 0,15
					0.20	65	8,000 – 13,000	20,000	10	43204007	PBU 1010/6 INOX 0,20
					0.35	65	8,000 – 13,000	20,000	10	43204003	PBU 1010/6 INOX 0,35
13	12	6	20	-	0.15	65	8,000 – 13,000	20,000	10	43204109	PBU 1312/6 INOX 0,15
					0.20	65	8,000 – 13,000	20,000	10	43204107	PBU 1312/6 INOX 0,20
					0.35	65	8,000 – 13,000	20,000	10	43204103	PBU 1312/6 INOX 0,35
15	16	6	22	-	0.15	65	7,200 – 11,700	18,000	10	43203011	PBU 1516/6 INOX 0,15
										43203007	PBU 1516/6 INOX 0,20
										43704014	POS PBU 1516/6 INOX 0,20
										43203003	PBU 1516/6 INOX 0,35
20	22	6	25	-	0.20	70	7,200 – 11,700	18,000	10	43704002	POS PBU 1516/6 INOX 0,35
										43202011	PBU 2022/6 INOX 0,15
										43202007	PBU 2022/6 INOX 0,20
										43704015	POS PBU 2022/6 INOX 0,20
30	29	6	25	-	0.50	70	7,200 – 11,700	18,000	10	43202003	PBU 2022/6 INOX 0,50
										43704006	POS PBU 2022/6 INOX 0,50
										43201011	PBU 3029/6 INOX 0,15
					0.20	70	6,000 – 9,800	15,000	10	43201007	PBU 3029/6 INOX 0,20
					0.50	70	6,000 – 9,800	15,000	10	43201003	PBU 3029/6 INOX 0,50

Brass wire (MES)

10	10	6	20	-	0.30	65	8,000 – 13,000	20,000	10	43204002	PBU 1010/6 MES 0,30
13	12	6	20	-	0.30	65	8,000 – 13,000	20,000	10	43204102	PBU 1312/6 MES 0,30
15	16	6	22	-	0.30	65	7,200 – 11,700	18,000	10	43203002	PBU 1516/6 MES 0,30
20	22	6	25	-	0.50	70	7,200 – 11,700	18,000	10	43202002	PBU 2022/6 MES 0,50

Continued on next page



Shank-mounted end brushes

crimped



D [mm]	D _c [mm]	D _s [mm]	L _T [mm]	Grit size	D _f [mm]	L [mm]	Opt. RPM	Max. RPM		Item no.	Designation
30	29	6	25	-	0.50	70	6,000 – 9,800	15,000	10	43201002	PBU 3029/6 MES 0,50

Silicon carbide (SiC) plastic filament

10	10	6	20	180	0.90	65	8,000 – 13,000	20,000	10	43204004	PBU 1010/6 SiC 180 0,90
13	12	6	20	180	0.90	65	8,000 – 13,000	20,000	10	43204104	PBU 1312/6 SiC 180 0,90
15	16	6	22	180	0.90	65	7,200 – 11,700	18,000	10	43203004	PBU 1516/6 SiC 180 0,90
20	22	6	25	180	0.90	70	7,200 – 11,700	18,000	10	43202004	PBU 2022/6 SiC 180 0,90
										43704008	POS PBU 2022/6 SiC 180 0,90
30	29	6	25	180	0.90	70	6,000 – 9,800	15,000	10	43201004	PBU 3029/6 SiC 180 0,90

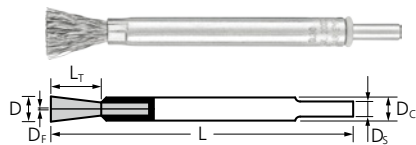

PBUL, long

Suitable for light brushing such as deburring, cleaning and derusting. Particularly long version to access deep areas.

Special features:

- Optimal access to hard-to-reach areas.

- Creates fine surfaces.

D [mm]	D _c [mm]	D _s [mm]	L _T [mm]	D _f [mm]	L [mm]	Opt. RPM	Max. RPM		Item no.	Designation
--------	---------------------	---------------------	---------------------	---------------------	--------	----------	----------	--	----------	-------------

Steel wire (ST)

10	10	6	20	0.20	120	4,000 – 9,500	20,000	10	43216001	PBUL 1010/6 ST 0,20
				0.30	120	4,000 – 9,500	20,000	10	43216002	PBUL 1010/6 ST 0,30

Stainless steel wire (INOX) – Supplied with plastic-covered brush body. All INOX brushes are degreased.

10	10	6	20	0.20	120	3,500 – 9,000	20,000	10	43216005	PBUL 1010/6 INOX 0,20
				0.30	120	3,500 – 9,000	20,000	10	43216006	PBUL 1010/6 INOX 0,30

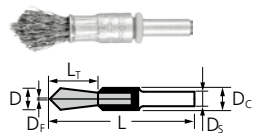

PBUS, pointed

Suitable for light brushing such as deburring, cleaning and derusting. Tapered tip for superb accuracy.



Special features:

- Optimal access to hard-to-reach areas.
- Creates fine surfaces.

D [mm]	D _c [mm]	D _s [mm]	L _T [mm]	D _f [mm]	L [mm]	Opt. RPM	Max. RPM		Item no.	Designation
--------	---------------------	---------------------	---------------------	---------------------	--------	----------	----------	--	----------	-------------

Steel wire (ST)

10	10	6	20	0.30	60	10,000 – 15,000	20,000	10	43217002	PBUS 1010/6 ST 0,30
----	----	---	----	------	----	-----------------	--------	----	----------	---------------------

Stainless steel wire (INOX) – Supplied with plastic-covered brush body. All INOX brushes are degreased.

10	10	6	20	0.30	60	8,000 – 13,000	20,000	10	43217006	PBUS 1010/6 INOX 0,30
----	----	---	----	------	----	----------------	--------	----	----------	-----------------------



Shank-mounted end brushes

crimped

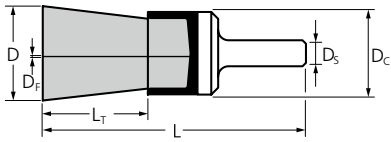

PBV, encapsulated

Particularly aggressive brushing effect for heavy-duty brushing.

Special features:

- Focused working thanks to high dimensional stability.
- Maximum tool life as premature wire breakage is prevented.

D [mm]	D _c [mm]	D _s [mm]	L _r [mm]	D _f [mm]	L [mm]	Opt. RPM	Max. RPM		Item no.	Designation
--------	---------------------	---------------------	---------------------	---------------------	--------	----------	----------	--	----------	-------------

Steel wire (ST)

22	22	6	25	0.25	70	6,500 – 9,800	13,000	10	43208001	PBV 2222/6 ST 0,25
30	29	6	25	0.35	70	6,500 – 9,800	13,000	10	43208005	PBV 3029/6 ST 0,35

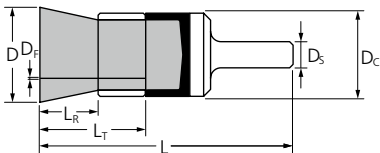

PBUR, with bridle

Suitable for light brushing such as deburring, cleaning and derusting. The bridle prevents the wires spreading out sideways. The bridle enables the spreading out and flexibility of the brush filament to be strictly controlled.



- If the filament has worn away down to the bridle, it can be removed from the bridle for further use. This does not affect the brushing behaviour.
- Creates fine surfaces.

Special features:

- Optimal access to hard-to-reach areas such as recesses and drilled holes.

D [mm]	D _c [mm]	D _s [mm]	L _r [mm]	L _r [mm]	L [mm]	D _f [mm]	Opt. RPM	Max. RPM		Item no.	Designation
--------	---------------------	---------------------	---------------------	---------------------	--------	---------------------	----------	----------	---	----------	-------------

Steel wire (ST)

13	16	6	13	25	70	0.20	7,500 – 11,300	15,000	10	43212001	PBUR 1316/6 ST 0,20
						0.35	7,500 – 11,300	15,000	10	43215001	PBUR 1316/6 ST 0,35
20	22	6	13	25	70	0.20	6,300 – 9,400	12,500	10	43213001	PBUR 2022/6 ST 0,20
						0.35	6,300 – 9,400	12,500	10	43213002	PBUR 2022/6 ST 0,35
25	30	6	13	25	70	0.20	6,300 – 9,400	12,500	10	43214001	PBUR 2530/6 ST 0,20
						0.35	6,300 – 9,400	12,500	10	43214002	PBUR 2530/6 ST 0,35

Stainless steel wire (INOX) – Supplied with plastic-covered brush body. All INOX brushes are degreased.

13	16	6	13	25	70	0.20	6,000 – 9,800	15,000	10	43212003	PBUR 1316/6 INOX 0,20
20	22	6	13	25	70	0.20	5,000 – 8,100	12,500	10	43213004	PBUR 2022/6 INOX 0,20
25	30	6	13	25	70	0.20	5,000 – 8,100	12,500	10	43214004	PBUR 2530/6 INOX 0,20

Shank-mounted end brushes

knotted

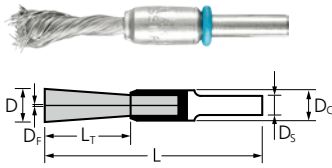

PBGS, SINGLETWIST

Particularly flexible single-knot brush for special applications.



Special features:

- Optimal access to hard-to-reach areas such as inside corners, as the knot is less likely to unravel.

D [mm]	D _c [mm]	D _s [mm]	L _r [mm]	L [mm]	D _f [mm]	Opt. RPM	Max. RPM		Item no.	Designation
Steel wire (ST)										
10	10	6	25	65	0.20	5,000 – 7,500	10,000	10	43218001	PBGS 1010/6 ST 0,20
					0.35	5,000 – 7,500	10,000	10	43218002	PBGS 1010/6 ST 0,35
					0.50	5,000 – 7,500	10,000	10	43218003	PBGS 1010/6 ST 0,50
12	10	6	28	71	0.20	5,000 – 7,500	10,000	10	43218011	PBGS 1210/6 ST 0,20

Stainless steel wire (INOX) – Supplied with plastic-covered brush body. All INOX brushes are degreased.

10	10	6	25	65	0.20	4,000 – 6,500	10,000	10	43218005	PBGS 1010/6 INOX 0,20
					0.35	4,000 – 6,500	10,000	10	43218006	PBGS 1010/6 INOX 0,35
					0.50	4,000 – 6,500	10,000	10	43218007	PBGS 1010/6 INOX 0,50
12	10	6	28	71	0.20	4,000 – 6,500	10,000	10	43218015	PBGS 1210/6 INOX 0,20

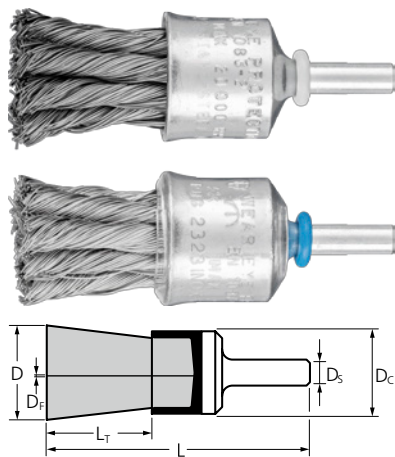

PBG

Aggressive brush. Suitable for medium-duty brushing such as deburring, cleaning, derusting and descaling, as well as removing spatter.



Special features:

- Optimal access to hard-to-reach areas such as recesses and drilled holes.
- Aggressive brushing effect due to the very stiff wire knots.

D [mm]	D _c [mm]	D _s [mm]	L _r [mm]	D _f [mm]	L [mm]	Knots	Opt. RPM	Max. RPM		Item no.	Designation
Steel wire (ST)											
19	19	6	28	0.25	68	6	10,000 – 15,000	20,000	10	43207012	PBG 1919/6 ST 0,25
				0.35	68	6	10,000 – 15,000	20,000	10	43207001	PBG 1919/6 ST 0,35
				0.50	68	6	10,000 – 15,000	20,000	10	43706001	POS PBG 1919/6 ST 0,35
										43207005	PBG 1919/6 ST 0,50
										43706003	POS PBG 1919/6 ST 0,50
23	23	6	28	0.25	68	8	10,000 – 15,000	20,000	10	43208021	PBG 2323/6 ST 0,25
				0.35	68	8	10,000 – 15,000	20,000	10	43208026	PBG 2323/6 ST 0,35
				0.50	68	8	10,000 – 15,000	20,000	10	43208031	PBG 2323/6 ST 0,50
30	28	6	25	0.25	68	12	8,000 – 11,300	20,000	10	43209011	PBG 3028/6 ST 0,25
				0.35	68	12	8,000 – 11,300	20,000	10	43209001	PBG 3028/6 ST 0,35

Continued on next page

Shank-mounted end brushes

knotted



D [mm]	D _c [mm]	D _s [mm]	L _r [mm]	D _f [mm]	L [mm]	Knots	Opt. RPM	Max. RPM		Item no.	Designation
30	28	6	25	0.35	68	12	8,000 – 11,300	20,000	10	43706005	POS PBG 3028/6 ST 0,35
				0.50	68	12	8,000 – 11,300	20,000	10	43209002	PBG 3028/6 ST 0,50
										43706007	POS PBG 3028/6 ST 0,50

Stainless steel wire (INOX) – Supplied with plastic-covered brush body. All INOX brushes are degreased.

19	19	6	28	0.15	68	6	8,000 – 13,000	20,000	10	43207011	PBG 1919/6 INOX 0,15
				0.25	68	6	8,000 – 13,000	20,000	10	43207013	PBG 1919/6 INOX 0,25
				0.35	68	6	8,000 – 13,000	20,000	10	43207003	PBG 1919/6 INOX 0,35
										43706002	POS PBG 1919/6 INOX 0,35
				0.60	68	6	8,000 – 13,000	20,000	10	43207007	PBG 1919/6 INOX 0,60
23	23	6	28	0.15	68	8	8,000 – 13,000	20,000	10	43208012	PBG 2323/6 INOX 0,15
				0.25	68	8	8,000 – 13,000	20,000	10	43208022	PBG 2323/6 INOX 0,25
				0.35	68	8	8,000 – 13,000	20,000	10	43208027	PBG 2323/6 INOX 0,35
				0.60	68	8	8,000 – 13,000	20,000	10	43208032	PBG 2323/6 INOX 0,60
30	28	6	25	0.15	68	12	6,000 – 9,800	20,000	10	43209007	PBG 3028/6 INOX 0,15
				0.25	68	12	6,000 – 9,800	20,000	10	43209012	PBG 3028/6 INOX 0,25
				0.35	68	12	6,000 – 9,800	20,000	10	43209004	PBG 3028/6 INOX 0,35
										43706006	POS PBG 3028/6 INOX 0,35
				0.60	68	12	6,000 – 9,800	20,000	10	43209005	PBG 3028/6 INOX 0,60



Shank-mounted cup brushes

crimped

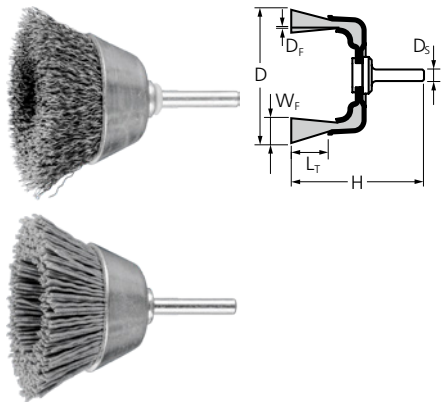

TBU

Generally suitable for cleaning, derusting and smoothing, as well as removal of corrosion and paint. Particularly suitable for brushing on large, flat and easily accessible surfaces due to face-down use with the entire brush face applied to the workpiece.



Special features:

- Highly flexible, enabling optimal adjustment to the workpiece contour.
- Creates fine surfaces.

D [mm]	W _f [mm]	D _s [mm]	L _r [mm]	Grit size	D _f [mm]	H [mm]	Opt. RPM	Max. RPM		Item no.	Designation
Steel wire (ST)											
30	10	6	15	-	0.20	60	5,300 – 7,900	10,500	10	43209701	TBU 3010/6 ST 0,20
40	15	6	20	-	0.20	70	5,300 – 7,900	10,500	10	43209711	TBU 4015/6 ST 0,20
50	10	6	20	-	0.30	75	5,300 – 7,900	10,500	10	43210001	TBU 5010/6 ST 0,30
									5	43703001	POS TBU 5010/6 ST 0,30
60	15	6	20	-	0.30	85	2,200 – 3,400	4,500	10	43211001	TBU 6015/6 ST 0,30
70	15	6	22	-	0.20	80	3,000 – 4,500	6,000	10	43211201	TBU 7015/6 ST 0,20
					0.30	80	3,000 – 4,500	6,000	10	43211202	TBU 7015/6 ST 0,30

Stainless steel wire (INOX) – Supplied with plastic-covered brush body.

30	10	6	15	-	0.20	60	4,200 – 6,800	10,500	10	43209704	TBU 3010/6 INOX 0,20
40	15	6	20	-	0.20	70	4,200 – 6,800	10,500	10	43209714	TBU 4015/6 INOX 0,20
50	10	6	20	-	0.30	75	4,200 – 6,800	10,500	10	43210003	TBU 5010/6 INOX 0,30
									5	43703002	POS TBU 5010/6 INOX 0,30
60	15	6	20	-	0.30	85	1,800 – 2,900	4,500	10	43211003	TBU 6015/6 INOX 0,30
70	15	6	22	-	0.20	80	2,400 – 4,000	6,000	10	43211204	TBU 7015/6 INOX 0,20
					0.30	80	2,400 – 4,000	6,000	10	43211205	TBU 7015/6 INOX 0,30

Silicon carbide (SiC) plastic filament

50	10	6	20	180	0.90	75	4,200 – 6,800	10,500	10	43210004	TBU 5010/6 SiC 180 0,90
									5	43703003	POS TBU 5010/6 SiC 180 0,90
60	15	6	20	180	0.90	85	1,800 – 2,900	4,500	10	43211004	TBU 6015/6 SiC 180 0,90

Ceramic oxide grain (CO) plastic filament

50	15	6	22	120	1.10	75	4,200 – 6,800	10,500	10	43210025	TBU 5015/6 CO 120 1,10
----	----	---	----	-----	------	----	---------------	--------	----	----------	------------------------

Shank-mounted cup brushes

crimped

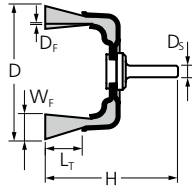

TBU, with cord wire

Generally suitable for cleaning, derusting and smoothing, as well as removal of corrosion and paint. Particularly suitable for brushing on large, flat and easily accessible surfaces due to face-down use with the entire brush face applied to the workpiece. Brushes with cord wire are particularly robust and durable and are therefore ideally suited to demanding tasks. Cord wire is made of multiple wavy wires which are stranded together. This special wire construction combines the aggressive brushing effect of a knotted brush with the flexibility of a wavy brush, achieving an excellent surface finish and a longer tool life.

Special features:

- Highly flexible, enabling optimal adjustment to the workpiece contour.
- Aggressive and effective work due to the special wire construction.
- Longer tool life compared to conventional crimped brushes.

D [mm]	W _F [mm]	D _S [mm]	L _T [mm]	D _F [mm]	H [mm]	Opt. RPM	Max. RPM		Item no.	Designation
Brass-plated steel cord wire (LIT STM)										
50	10	6	20	0.25	75	5,300 – 7,900	10,500	10	43210005	TBU 5010/6 LIT STM 0,25

Shank-mounted bevel brushes

crimped

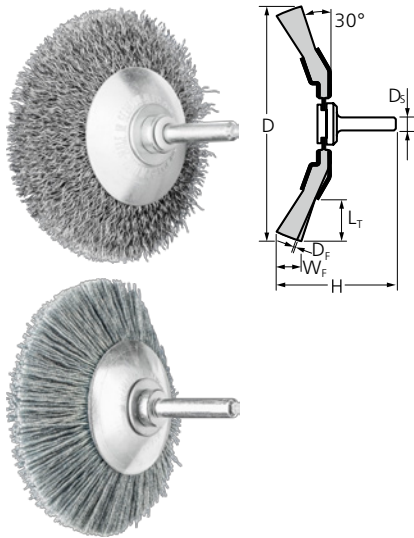

KBU

Excellent for medium-duty brushing such as deburring, cleaning and derusting.



Special features:

- Optimal access to hard-to-reach areas such as inner edges, grooves and keyways.
- Highly flexible, enabling optimal adjustment to the workpiece contour.
- Creates fine surfaces.

D [mm]	W _F [mm]	D _S [mm]	L _T [mm]	Grit size	D _F [mm]	H [mm]	Opt. RPM	Max. RPM		Item no.	Designation
Steel wire (ST)											
50	10	6	10	-	0.20	49	7,500 – 11,300	15,000	10	43220016	KBU 5010/6 ST 0,20
70	10	6	15	-	0.30	58	7,500 – 11,300	15,000	10	43220061	KBU 7010/6 ST 0,30
80	10	6	20	-	0.30	62	6,000 – 9,000	12,000	10	43220081	KBU 8010/6 ST 0,30
95	10	6	25	-	0.30	62	6,000 – 9,000	12,000	10	43312501	KBU 9510/6 ST 0,30

Stainless steel wire (INOX) – All INOX brushes are degreased.

50	10	6	10	-	0.20	49	6,000 – 9,800	15,000	10	43220017	KBU 5010/6 INOX 0,20
70	10	6	15	-	0.15	58	6,000 – 9,800	15,000	10	43220052	KBU 7010/6 INOX 0,15
					0.20	58	6,000 – 9,800	15,000	10	43220057	KBU 7010/6 INOX 0,20
80	10	6	20	-	0.30	62	4,800 – 7,800	12,000	10	43220082	KBU 8010/6 INOX 0,30
95	10	6	25	-	0.30	62	4,800 – 7,800	12,000	10	43312503	KBU 9510/6 INOX 0,30

Silicon carbide (SiC) plastic filament

70	10	6	15	120	0.55	58	6,000 – 9,800	15,000	10	43220070	KBU 7010/6 SiC 120 0,55
80	10	6	20	120	0.55	62	4,800 – 7,800	12,000	10	43220090	KBU 8010/6 SiC 120 0,55
95	10	6	25	120	1.10	62	4,800 – 7,800	12,000	10	43220110	KBU 9510/6 SiC 120 1,10

Ceramic oxide grain (CO) plastic filament

70	10	6	15	120	0.55	58	6,000 – 9,800	15,000	10	43220075	KBU 7010/6 CO 120 0,55
80	10	6	20	120	0.55	62	4,800 – 7,800	12,000	10	43220095	KBU 8010/6 CO 120 0,55
95	10	6	25	120	1.10	62	4,800 – 7,800	12,000	10	43220115	KBU 9510/6 CO 120 1,10



Shank-mounted bevel brushes

crimped

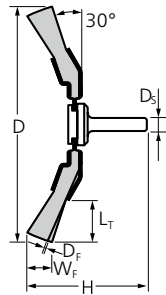

KBU, with cord wire

Excellent for medium-duty brushing such as deburring, cleaning and derusting. Brushes with cord wire are particularly robust and durable and are therefore ideally suited to demanding tasks. Cord wire is made of multiple wavy wires which are stranded together. This special wire construction combines the aggressive brushing effect of a knotted brush with the flexibility of a wavy brush, achieving an excellent surface finish and a longer tool life.

Special features:

- Highly flexible, enabling optimal adjustment to the workpiece contour.
- Aggressive and effective work due to the special wire construction.
- Longer tool life compared to conventional crimped brushes.

D [mm]	W _F [mm]	D _S [mm]	L _T [mm]	D _F [mm]	H [mm]	Opt. RPM	Max. RPM		Item no.	Designation
Brass-plated steel cord wire (LIT STM)										
70	10	6	15	0.25	58	7,500 – 11,300	15,000	10	43220062	KBU 7010/6 LIT STM 0,25

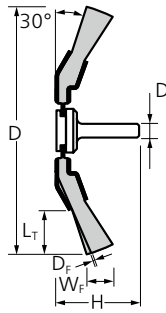

KBU RS

Excellent for medium-duty brushing such as deburring, cleaning and derusting. Type with backwards shank for convenient and safe backwards working.

Special features:

- Optimal access to hard-to-reach areas such as inner edges, grooves and keyways.
- Highly flexible, enabling optimal adjustment to the workpiece contour.
- Creates fine surfaces.

D [mm]	W _F [mm]	D _S [mm]	L _T [mm]	Grit size	D _F [mm]	H [mm]	Opt. RPM	Max. RPM		Item no.	Designation
Silicon carbide (SiC) plastic filament											
70	10	6	15	120	0.55	50	6,000 – 9,800	15,000	10	43220080	KBU 7010/6 SiC 120 0,55 RS
Ceramic oxide grain (CO) plastic filament											
70	10	6	15	120	0.55	50	6,000 – 9,800	15,000	10	43220085	KBU 7010/6 CO 120 0,55 RS

Shank-mounted wheel brushes

crimped

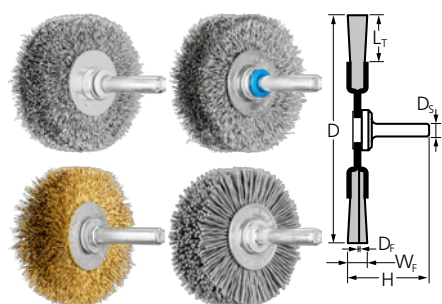

RBU

Generally suitable for cleaning, derusting, smoothing, cleaning of weld seams, light deburring, and removal of corrosion and paint.



Special features:

- Highly flexible, enabling optimal adjustment to the workpiece contour.
- Creates fine surfaces.

D [mm]	W _f [mm]	D _s [mm]	L _t [mm]	Grit size	D _p [mm]	H [mm]	Opt. RPM	Max. RPM		Item no.	Designation	
Steel wire (ST)												
20	4	6	3	-	0.20	37	10,000 – 15,000	20,000	10	43101001	RBU 2004/6 ST 0,20	
30	6	6	7	-	0.20	40	10,000 – 15,000	20,000	10	43102001	RBU 3006/6 ST 0,20	
										43701005	POS RBU 3006/6 ST 0,20	
	9	6	7	-	0.20	42	10,000 – 15,000	20,000	10	43102021	RBU 3009/6 ST 0,20	
40	9	6	9	-	0.20	46	9,000 – 13,500	18,000	10	43103001	RBU 4009/6 ST 0,20	
50	4	6	9	-	0.20	41	7,500 – 11,300	15,000	10	43103021	RBU 5004/6 ST 0,20	
										43103102	RBU 5010/6 ST 0,20	
										43104001	RBU 5015/6 ST 0,20	
	10	6	13	-	0.20	50	7,500 – 11,300	15,000	10	43701013	POS RBU 5015/6 ST 0,20	
	15	6	13	-	0.20	50	7,500 – 11,300	15,000	10	43104001	RBU 5015/6 ST 0,20	
60	10	6	15	-	0.20	50	7,500 – 11,300	15,000	10	43104009	RBU 6010/6 ST 0,20	
										43104011	RBU 6015/6 ST 0,20	
70	4	6	9	-	0.20	41	7,500 – 11,300	15,000	10	43104051	RBU 7004/6 ST 0,20	
										43104101	RBU 7010/6 ST 0,30	
										43105001	RBU 7015/6 ST 0,30	
	10	6	19	-	0.30	50	7,500 – 11,300	15,000	10	43701017	POS RBU 7015/6 ST 0,30	
	15	6	19	-	0.30	50	7,500 – 11,300	15,000	10	43105021	RBU 8004/6 ST 0,20	
80	4	6	10	-	0.20	41	6,000 – 9,000	12,000	10	43105021	RBU 8004/6 ST 0,20	
										43106001	RBU 8015/6 ST 0,30	
100	10	6	25	-	0.30	50	6,000 – 9,000	12,000	10	43109001	RBU 10010/6 ST 0,30	
										43701018	POS RBU 10010/6 ST 0,30	
										43109005	RBU 10015/6 ST 0,20	
										43109004	RBU 10015/6 ST 0,30	
	20	6	25	-	0.20	51	6,000 – 9,000	12,000	10	43109007	RBU 10020/6 ST 0,20	
54						6,000 – 9,000	12,000	10	43109006	RBU 10020/6 ST 0,30		

Stainless steel wire (INOX)

20	4	6	3	-	0.20	37	8,000 – 13,000	20,000	10	43101003	RBU 2004/6 INOX 0,20
30	6	6	7	-	0.20	40	8,000 – 13,000	20,000	10	43102003	RBU 3006/6 INOX 0,20
										43701006	POS RBU 3006/6 INOX 0,20
	9	6	7	-	0.20	42	8,000 – 13,000	20,000	10	43102023	RBU 3009/6 INOX 0,20
40	9	6	9	-	0.20	46	7,200 – 11,700	18,000	10	43103003	RBU 4009/6 INOX 0,20
50	4	6	9	-	0.20	41	6,000 – 9,800	15,000	10	43103023	RBU 5004/6 INOX 0,20
										43103103	RBU 5010/6 INOX 0,20
										43104003	RBU 5015/6 INOX 0,20
	10	6	13	-	0.20	50	6,000 – 9,800	15,000	10	43701014	POS RBU 5015/6 INOX 0,20
	15	6	13	-	0.20	50	6,000 – 9,800	15,000	10	43104010	RBU 6010/6 INOX 0,20
60	10	6	15	-	0.20	50	6,000 – 9,800	15,000	10	43104033	RBU 6015/6 INOX 0,20
										43104053	RBU 7004/6 INOX 0,20
70	4	6	9	-	0.20	41	6,000 – 9,800	15,000	10	43104102	RBU 7010/6 INOX 0,20
										43104106	RBU 7015/6 INOX 0,15
										43104106	RBU 7015/6 INOX 0,15

Continued on next page

Shank-mounted wheel brushes

crimped



D [mm]	W _f [mm]	D _s [mm]	L _T [mm]	Grit size	D _f [mm]	H [mm]	Opt. RPM	Max. RPM		Item no.	Designation
70	15	6	19	-	0.30	50	6,000 – 9,800	15,000	10	43105003	RBU 7015/6 INOX 0,30
										43701019	POS RBU 7015/6 INOX 0,30
80	4	6	10	-	0.20	41	4,800 – 7,800	12,000	10	43105023	RBU 8004/6 INOX 0,20
										43105103	RBU 8010/6 INOX 0,20
	15	6	19	-	0.15	50	4,800 – 7,800	12,000	10	43106102	RBU 8015/6 INOX 0,15
										43106003	RBU 8015/6 INOX 0,30
100	10	6	25	-	0.30	50	4,800 – 7,800	12,000	10	43109003	RBU 10010/6 INOX 0,30
										43701020	POS RBU 10010/6 INOX 0,30
	15	6	25	-	0.20	51	4,800 – 7,800	12,000	10	43109009	RBU 10015/6 INOX 0,20
										43109008	RBU 10015/6 INOX 0,30
	20	6	25	-	0.20	54	4,800 – 7,800	12,000	10	43109011	RBU 10020/6 INOX 0,20
										43109010	RBU 10020/6 INOX 0,30

Brass wire (MES)

20	4	6	3	-	0.20	37	8,000 – 13,000	20,000	10	43101002	RBU 2004/6 MES 0,20
30	6	6	7	-	0.20	40	8,000 – 13,000	20,000	10	43102002	RBU 3006/6 MES 0,20
40	9	6	9	-	0.20	46	7,200 – 11,700	18,000	10	43103002	RBU 4009/6 MES 0,20
50	15	6	13	-	0.20	50	6,000 – 9,800	15,000	10	43104002	RBU 5015/6 MES 0,20
70	15	6	19	-	0.30	50	6,000 – 9,800	15,000	10	43105002	RBU 7015/6 MES 0,30
80	15	6	19	-	0.30	50	4,800 – 7,800	12,000	10	43106002	RBU 8015/6 MES 0,30

Silicon carbide (SiC) plastic filament

50	4	6	10	120	0.55	50	6,000 – 9,800	15,000	10	43103025	RBU 5004/6 SiC 120 0,55
	10	6	13	180	0.90	50	6,000 – 9,800	15,000	10	43103101	RBU 5010/6 SiC 180 0,90
	15	6	13	180	0.90	50	6,000 – 9,800	15,000	10	43104004	RBU 5015/6 SiC 180 0,90
70	8	6	19	120	0.55	50	6,000 – 9,800	15,000	10	43701016	POS RBU 5015/6 SiC 180 0,90
										43104075	RBU 7008/6 SiC 120 0,55
	15	6	19	180	0.90	50	6,000 – 9,800	15,000	10	43105004	RBU 7015/6 SiC 180 0,90
80	8	6	19	120	0.55	50	4,800 – 7,800	12,000	10	43701025	POS RBU 7015/6 SiC 180 0,90
										43105075	RBU 8008/6 SiC 120 0,55
	15	6	19	180	0.90	50	4,800 – 7,800	12,000	10	43106004	RBU 8015/6 SiC 180 0,90

Ceramic oxide grain (CO) plastic filament

50	4	6	10	120	0.55	50	6,000 – 9,800	15,000	10	43103028	RBU 5004/6 CO 120 0,55
	15	6	13	120	1.10	50	6,000 – 9,800	15,000	10	43104008	RBU 5015/6 CO 120 1,10
70	8	6	19	120	0.55	50	6,000 – 9,800	15,000	10	43104078	RBU 7008/6 CO 120 0,55
	15	6	19	120	1.10	50	6,000 – 9,800	15,000	10	43105008	RBU 7015/6 CO 120 1,10
80	8	6	19	120	0.55	50	4,800 – 7,800	12,000	10	43105078	RBU 8008/6 CO 120 0,55
	15	6	19	120	1.10	50	4,800 – 7,800	12,000	10	43106008	RBU 8015/6 CO 120 1,10



Shank-mounted wheel brushes

crimped

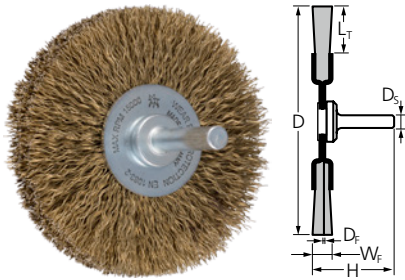

RBU, with cord wire

Generally suitable for cleaning, derusting, smoothing, cleaning of weld seams, light deburring, and removal of corrosion and paint. Brushes with cord wire are particularly robust and durable and are therefore ideally suited to demanding tasks. Cord wire is made of multiple wavy wires which are stranded together. This special wire construction combines the aggressive brushing effect of a knotted brush with the flexibility of a wavy brush, achieving an excellent surface finish and a longer tool life.

Special features:

- Highly flexible, enabling optimal adjustment to the workpiece contour.
- Aggressive and effective work due to the special wire construction.
- Longer tool life compared to conventional crimped brushes.

D [mm]	W _F [mm]	D _S [mm]	L _T [mm]	D _F [mm]	H [mm]	Opt. RPM	Max. RPM		Item no.	Designation
--------	---------------------	---------------------	---------------------	---------------------	--------	----------	----------	--	----------	-------------

Brass-plated steel cord wire (LIT STM)

70	15	6	19	0.25	50	7,500 – 11,300	15,000	10	43105005	RBV 7015/6 LIT STM 0,25
----	----	---	----	------	----	----------------	--------	----	----------	-------------------------

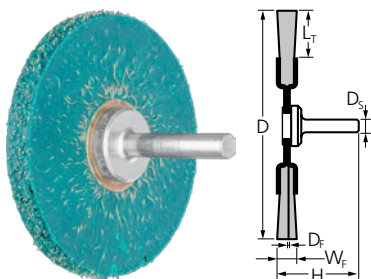

RBV, encapsulated

Particularly aggressive brushing effect for heavy-duty brushing.

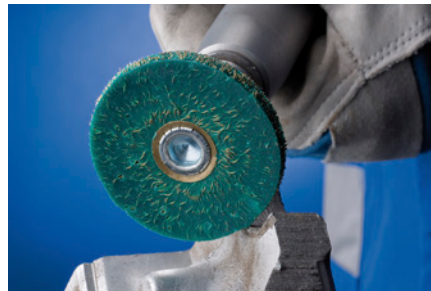

Special features:

- Focused working thanks to high dimensional stability.
- Maximum tool life as premature wire breakage is prevented.

D [mm]	W _F [mm]	D _S [mm]	L _T [mm]	D _F [mm]	H [mm]	Opt. RPM	Max. RPM		Item no.	Designation
--------	---------------------	---------------------	---------------------	---------------------	--------	----------	----------	--	----------	-------------

Steel wire (ST) – ST = brass-plated steel wire

63	7	6	20	0.30	40	7,500 – 11,300	15,000	1	43507501	RBV 6307/6 ST 0,30
----	---	---	----	------	----	----------------	--------	---	----------	--------------------

Shank-mounted wheel brushes

knotted

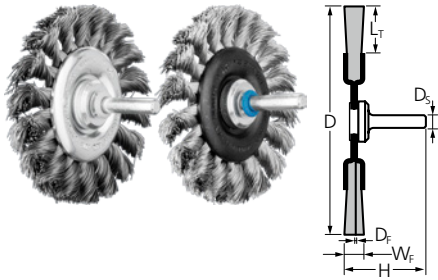

RBG

Aggressive brush for cleaning, derusting and work on weld seams.

Special features:

- Optimal access to hard-to-reach areas such as grooves and recesses.
- Aggressive brushing effect due to the very stiff wire knots.

D [mm]	W _f [mm]	D _s [mm]	L _t [mm]	D _f [mm]	H [mm]	Knots	Opt. RPM	Max. RPM		Item no.	Designation
Steel wire (ST)											
76	6	6	16	0.35	42	18	12,500 – 18,800	25,000	10	43107001	RBG 7006/6 ST 0,35
				0.50	42	18	12,500 – 18,800	25,000	10	43702001	POS RBG 7006/6 ST 0,35
	12	6	16	0.35	42	18	12,500 – 18,800	25,000	10	43107002	RBG 7006/6 ST 0,50
				0.50	42	18	12,500 – 18,800	25,000	10	43702003	POS RBG 7006/6 ST 0,50
100	12	6	19	0.35	42	22	10,000 – 15,000	20,000	10	43108001	RBG 10012/6 ST 0,35
				0.50	42	22	10,000 – 15,000	20,000	10	43108002	RBG 10012/6 ST 0,50

Stainless steel wire (INOX) – All INOX brushes are degreased.

76	6	6	16	0.35	42	18	10,000 – 16,300	25,000	10	43107003	RBG 7006/6 INOX 0,35
				0.50	42	18	10,000 – 16,300	25,000	10	43702002	POS RBG 7006/6 INOX 0,35
				0.50	42	18	10,000 – 16,300	25,000	10	43107004	RBG 7006/6 INOX 0,50
12	6	16	0.35	42	18	10,000 – 16,300	25,000	10	43107013	RBG 7012/6 INOX 0,35	
			0.50	42	18	10,000 – 16,300	25,000	10	43107014	RBG 7012/6 INOX 0,50	
100	12	6	19	0.35	42	22	8,000 – 13,000	20,000	10	43108005	RBG 10012/6 INOX 0,35
				0.50	42	22	8,000 – 13,000	20,000	10	43108006	RBG 10012/6 INOX 0,50

Brush sets

Brush sets



BSO

Set of different wheel, cup and end brushes with a 6 mm shank.

Special features:

- Selection of the most common versions.
- Promotional display box.

Contents	Contents [Piece]		Item no.	Designation
TBU 5010/6 ST 0,30, PBU 1010/6 ST 0,35, PBU 1516/6 ST 0,35, PBU 2022/6 ST 0,50, RBU 3006/6 ST 0,20, RBU 4009/6 ST 0,20, RBU 5015/6 ST 0,20, RBU 7015/6 ST 0,30	80	1	43900001	BSO 5500 ST

Wheel brushes for burnishing machines

crimped

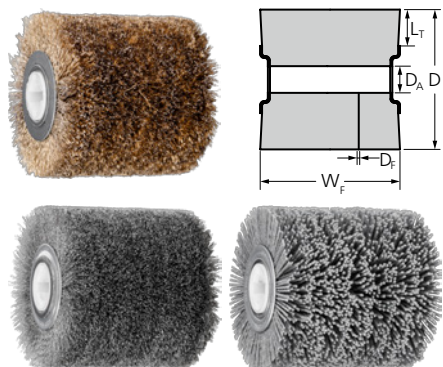

WBU, for burnishing machines

Excellent for surface structuring work on workpieces with large surfaces.



Special features:

- Can be used with all commercially available burnishing machines thanks to the hole with four keyways.
- Creates fine surfaces.

D [mm]	W _F [mm]	L _T [mm]	D _A [mm]	Grit size	D _F [mm]	Opt. RPM	Max. RPM		Item no.	Designation
Brass-plated steel cord wire (LIT STM)										
100	100	26	19.1	-	0.27	3,000 – 4,500	6,000	1	43509001	WBU 100100/19,1 LIT ST 0,27
Stainless steel wire (INOX)										
100	100	26	19.1	-	0.20	2,400 – 3,900	6,000	1	43509003	WBU 100100/19,1 INOX 0,20
Silicon carbide (SiC) plastic filament										
100	100	26	19.1	80	1.27	2,400 – 3,900	6,000	1	43509005	WBU 100100/19,1 SiC 80 1,27

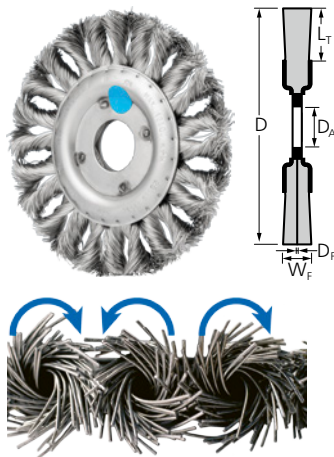

RBGIT CT, COMBITWIST

Very aggressive brush for heavy-duty brushing. Specially developed for work on stainless steel (INOX). Suitable for work on corners and edges as the knots are less likely to unravel.



Special features:

- Maximum protection against corrosion as all components are produced from stainless steel (INOX) in quality 1.4310/1.4301 (V2A). Particularly well-suited to use in extremely critical environments.
- Maximum economic efficiency due to maximum tool life and stock removal rate and high level of comfort thanks to smooth running with no brush recoiling.
- Aggressive brushing effect due to the very stiff wire knots.

D [mm]	W _F [mm]	L _T [mm]	D _A [mm]	D _F [mm]	Knots	Opt. RPM	Max. RPM		Item no.	Designation
--------	---------------------	---------------------	---------------------	---------------------	-------	----------	----------	---	----------	-------------

Stainless steel wire (INOX) – All INOX brushes are degreased.

115	12	22	22.2	0.35	24	5,000 – 12,500	12,500	1	43300042	POS RBGIT 11512/22,2 CT INOX 0,35
-----	----	----	------	------	----	----------------	--------	---	----------	-----------------------------------

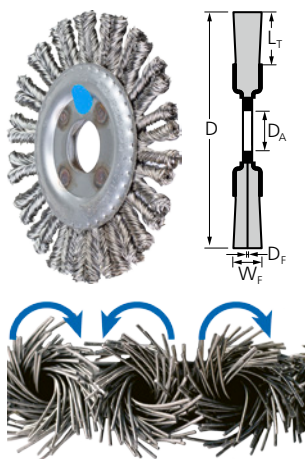

RBGIT PIPE CT, Pipeline, COMBITWIST

Brush that has been specially developed for work on stainless steel (INOX). Perfect for heavy-duty brushing in pipeline and container construction. Suitable for work on corners and edges as the knots are less likely to unravel.

Special features:

- Maximum protection against corrosion as all components are produced from stainless steel (INOX) in quality 1.4310/1.4301 (V2A). Particularly well-suited to use in extremely critical environments.
- Extra-slim design enables optimal access to hard-to-reach areas such as root weld seams.
- Maximum economic efficiency due to maximum tool life and stock removal rate and high level of comfort thanks to smooth running with no brush recoiling.

D [mm]	W _F [mm]	L _T [mm]	D _A [mm]	D _F [mm]	Knots	Opt. RPM	Max. RPM		Item no.	Designation
--------	---------------------	---------------------	---------------------	---------------------	-------	----------	----------	---	----------	-------------

Stainless steel wire (INOX) – All INOX brushes are degreased.

115	6	22	22.2	0.50	36	5,000 – 12,500	12,500	1	43300032	POS RBGIT 11506/22,2 PIPE CT INOX 0,50
-----	---	----	------	------	----	----------------	--------	---	----------	--

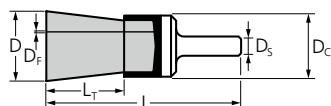

PBUIT, crimped

Suitable for light brushing such as deburring, cleaning, and removal of heat discoloration. Specially developed for work on stainless steel (INOX).

Special features:

- Maximum protection against corrosion as all components are produced from stainless steel (INOX) in quality 1.4310/1.4301 (V2A). Particularly well-suited to use in extremely critical environments.
- Optimal access to hard-to-reach areas such as drilled holes and cavities as the filament spreads out upon rotation.
- Creates fine surfaces.

D [mm]	D _c [mm]	D _s [mm]	L _r [mm]	D _f [mm]	L [mm]	Opt. RPM	Max. RPM		Item no.	Designation
--------	---------------------	---------------------	---------------------	---------------------	--------	----------	----------	---	----------	-------------

Stainless steel wire (INOX) – All INOX brushes are degreased.

15	16	6	22	0.15	65	7,200 – 11,700	18,000	10	43200022	PBUIT 1516/6 INOX 0,15
				0.20	65	7,200 – 11,700	18,000	10	43200027	PBUIT 1516/6 INOX 0,20
20	22	6	25	0.15	70	7,200 – 11,700	18,000	10	43200032	PBUIT 2022/6 INOX 0,15
				0.20	70	7,200 – 11,700	18,000	10	43200037	PBUIT 2022/6 INOX 0,20

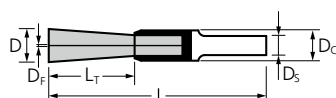

PBGST, SINGLETWIST, knotted

Particularly flexible single-knot brush for special applications. Specially developed for work on stainless steel (INOX).



Special features:

- Maximum protection against corrosion as all components are produced from stainless steel (INOX) in quality 1.4310/1.4301 (V2A). Particularly well-suited to use in extremely critical environments.
- Optimal access to hard-to-reach areas such as inside corners, as the knot is less likely to unravel.

D [mm]	D _c [mm]	D _s [mm]	L _r [mm]	D _f [mm]	L [mm]	Opt. RPM	Max. RPM		Item no.	Designation
--------	---------------------	---------------------	---------------------	---------------------	--------	----------	----------	---	----------	-------------

Stainless steel wire (INOX) – All INOX brushes are degreased.

10	10	6	25	0.20	65	4,000 – 6,500	10,000	10	43200102	PBGST 1010/6 INOX 0,20
				0.35	65	4,000 – 6,500	10,000	10	43200107	PBGST 1010/6 INOX 0,35

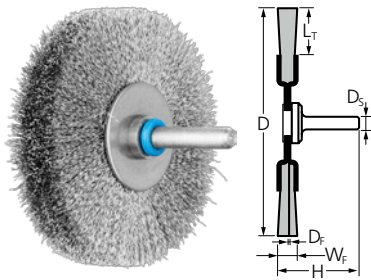

RBUIT

Generally suitable for cleaning, deburring and removal of heat discoloration. Specially developed for work on stainless steel (INOX).

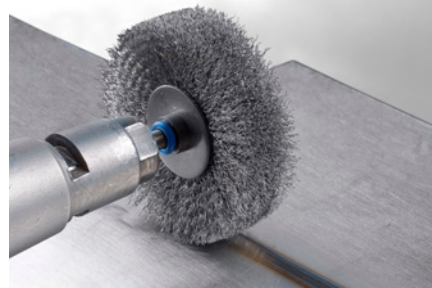

Special features:

- Maximum protection against corrosion as all components are produced from stainless steel (INOX) in quality 1.4310/1.4301 (V2A). Particularly well-suited to use in extremely critical environments.
- Highly flexible, enabling optimal adjustment to the workpiece contour.
- Creates fine surfaces.

D [mm]	W _f [mm]	D _s [mm]	L _t [mm]	D _f [mm]	H [mm]	Opt. RPM	Max. RPM		Item no.	Designation
--------	---------------------	---------------------	---------------------	---------------------	--------	----------	----------	---	----------	-------------

Stainless steel wire (INOX) – All INOX brushes are degreased.

30	6	6	7	0.20	40	8,000 – 13,000	20,000	10	43100012	RBUIT 3006/6 INOX 0,20
50	15	6	13	0.20	50	6,000 – 9,800	15,000	10	43100032	RBUIT 5015/6 INOX 0,20
70	15	6	19	0.15	50	6,000 – 9,800	15,000	10	43100062	RBUIT 7015/6 INOX 0,15
				0.30	50	6,000 – 9,800	15,000	10	43100067	RBUIT 7015/6 INOX 0,30
80	15	6	19	0.15	50	4,800 – 7,800	12,000	10	43100072	RBUIT 8015/6 INOX 0,15
				0.30	50	4,800 – 7,800	12,000	10	43100077	RBUIT 8015/6 INOX 0,30

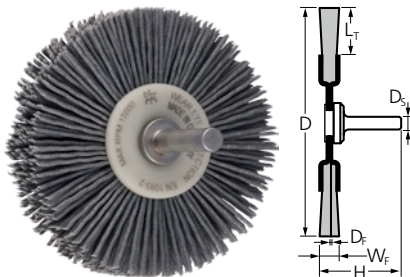

RBUIT, crimped with plastic filament and plastic side plates

Generally suitable for cleaning, deburring and removal of heat discoloration. Specially developed for work on stainless steel (INOX). Maximum protection against corrosion as all metallic components are produced from stainless steel (INOX) in quality 1.4310/1.4301 (V2A). Particularly well suited to use in extremely critical environments.

Special features:

- Plastic side plate prevents damage and contamination in the event of workpiece contact.
- All components are made from non-rusting materials.
- Highly flexible, enabling optimal adjustment to the workpiece contour. Creates fine surfaces.

D [mm]	W _f [mm]	D _s [mm]	L _t [mm]	Grit size	D _f [mm]	H [mm]	Opt. RPM	Max. RPM		Item no.	Designation
--------	---------------------	---------------------	---------------------	-----------	---------------------	--------	----------	----------	---	----------	-------------

Silicon carbide (SiC) plastic filament

50	15	6	13	180	0.90	50	6,000 – 9,800	15,000	10	43210008	RBUIT 5015/6 SIC 180 0.90 KS
70	15	6	19	180	0.90	50	6,000 – 9,800	15,000	10	43105006	RBUIT 7015/6 SIC 180 0,90 KS

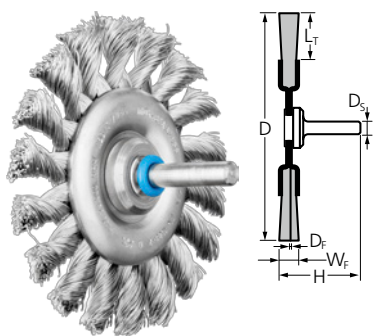

RBGIT, knotted

Generally suitable for cleaning, deburring and removal of heat discoloration. Specially developed for work on stainless steel (INOX).

Special features:

- Maximum protection against corrosion as all components are produced from stainless steel (INOX) in quality 1.4310/1.4301 (V2A). Particularly well-suited to use in extremely critical environments.
- Aggressive brushing effect due to the very stiff wire knots.

D [mm]	W _F [mm]	D _S [mm]	L _T [mm]	D _F [mm]	Knots	H [mm]	Opt. RPM	Max. RPM		Item no.	Designation
--------	---------------------	---------------------	---------------------	---------------------	-------	--------	----------	----------	---	----------	-------------

Stainless steel wire (INOX) – All INOX brushes are degreased.

76	6	6	16	0.35	18	42	10,000 – 16,300	25,000	10	43100252	RBGIT 7006/6 INOX 0,35
----	---	---	----	------	----	----	-----------------	--------	----	----------	------------------------

Shank-mounted bevel brushes

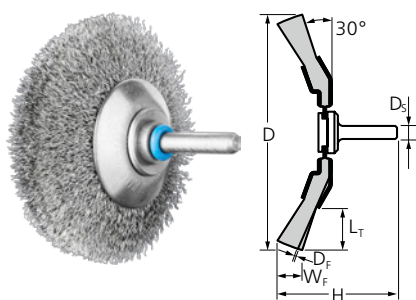

KBUIT

Excellent for medium-duty brushing such as deburring, cleaning, and removal of heat discoloration. Specially developed for work on stainless steel (INOX).



Special features:

- Maximum protection against corrosion as all components are produced from stainless steel (INOX) in quality 1.4310/1.4301 (V2A). Particularly well-suited to use in extremely critical environments.
- Optimal access to hard-to-reach areas such as inner edges, grooves and keyways.
- Highly flexible, enabling optimal adjustment to the workpiece contour. Creates fine surfaces.

D [mm]	W _F [mm]	D _S [mm]	L _T [mm]	D _F [mm]	H [mm]	Opt. RPM	Max. RPM		Item no.	Designation
--------	---------------------	---------------------	---------------------	---------------------	--------	----------	----------	---	----------	-------------

Stainless steel wire (INOX) – All INOX brushes are degreased.

50	10	6	10	0.20	49	6,000 – 9,800	15,000	10	43225017	KBUIT 5010/6 INOX 0,20
70	10	6	15	0.15	58	6,000 – 9,800	15,000	10	43225052	KBUIT 7010/6 INOX 0,15
				0.20	58	6,000 – 9,800	15,000	10	43225057	KBUIT 7010/6 INOX 0,20
80	10	6	20	0.30	62	4,800 – 7,800	12,000	10	43225087	KBUIT 8010/6 INOX 0,30

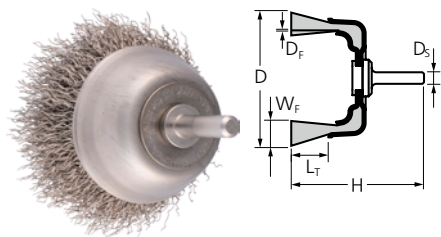

TBUIT, crimped

Specially developed for work on stainless steel (INOX). Generally suitable for cleaning, derusting and smoothing, as well as removal of corrosion and paint. Particularly suitable for brushing on large, flat and easily accessible surfaces due to face-down use with the entire brush face applied to the workpiece.

Special features:

- Maximum protection against corrosion as all components are produced from stainless steel (INOX) in quality 1.4310/1.4301 (V2A). Particularly well-suited to use in extremely critical environments.

- Highly flexible, enabling optimal adjustment to the workpiece contour.
- Creates fine surfaces.

D [mm]	D _S [mm]	D _F [mm]	Max. RPM		Item no.	Designation
--------	---------------------	---------------------	----------	---	----------	-------------

Stainless steel wire (INOX) – All INOX brushes are degreased.

50	6	0.30	10,500	10	43210006	TBUIT 5010/6 INOX 0,30
----	---	------	--------	----	----------	------------------------

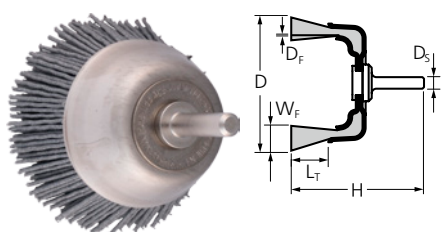

TBUIT, crimped with plastic filament

Generally suitable for cleaning, derusting and smoothing, as well as removal of corrosion and paint. Particularly suitable for brushing on large, flat and easily accessible surfaces due to face-down use with the entire brush face applied to the workpiece. Maximum protection against corrosion as all metallic components are produced from stainless steel (INOX) in quality 1.4310/1.4301 (V2A). Particularly well suited to use in extremely critical environments.

Special features:

- All components are made from non-rusting materials.

- Highly flexible, enabling optimal adjustment to the workpiece contour.
- Creates fine surfaces.

D [mm]	D _S [mm]	D _F [mm]	Grit size	Max. RPM		Item no.	Designation
--------	---------------------	---------------------	-----------	----------	---	----------	-------------

Silicon carbide (SiC) plastic filament

50	6	0.90		10,500	10	43210007	TBUIT 5010/6 SiC 180 0,90
----	---	------	--	--------	----	----------	---------------------------

Miniature brushes

End brushes, crimped

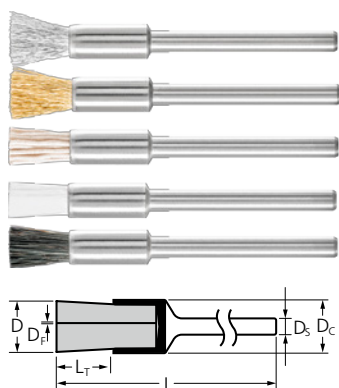

PBU

Suitable for light brushing such as deburring, cleaning and polishing. Miniature brushes can be used on flexible shaft drives, micro motors or electric grinders.



Special features:

- Maximum precision and efficiency in work on delicate workpieces.
- Optimal access to hard-to-reach areas such as drilled holes and cavities as the filament spreads out upon rotation.
- Creates fine surfaces.

D [mm]	D _c [mm]	D _s [mm]	L _r [mm]	Grit size	D _f [mm]	L [mm]	Opt. RPM	Max. RPM		Item no.	Designation
Steel wire (ST)											
5	5	3	8	-	0.10	45	5,000 – 15,000	25,000	10	43200351	PBU 0505/3 ST 0,10
Stainless steel wire (INOX)											
5	5	3	8	-	0.10	45	4,000 – 10,000	25,000	10	43200352	PBU 0505/3 INOX 0,10
Brass wire (MES)											
5	5	3	8	-	0.10	45	4,000 – 10,000	25,000	10	43200353	PBU 0505/3 MES 0,10
Silicon carbide (SiC) plastic filament											
5	5	3	8	320	0.55	45	1,200 – 5,000	25,000	10	43200354	PBU 0505/3 SiC 320 0,55
				800	0.25	45	1,200 – 5,000	25,000	10	43200355	PBU 0505/3 SiC 800 0,25
Aluminium oxide (AO) plastic filament											
5	5	3	8	320	0.50	45	1,200 – 5,000	25,000	10	43200361	PBU 0505/3 AO 320 0,50
				600	0.30	45	1,200 – 5,000	25,000	10	43200360	PBU 0505/3 AO 600 0,30
Diamond (DIA) plastic filament											
5	5	3	8	400	0.40	45	1,200 – 5,000	25,000	10	47701649	PBU 0505/3 DIA 400 0,40
Nylon plastic filament											
5	5	3	8	-	0.20	45	1,200 – 5,000	25,000	10	43200356	PBU 0505/3 Nylon 0,20
Natural bristles, white bristle (SBW)											
5	5	3	8	-	-	45	4,000 – 10,000	25,000	10	43200357	PBU 0505/3 SBW
Natural bristles, black bristle (SBS)											
5	5	3	8	-	-	45	4,000 – 10,000	25,000	10	43200358	PBU 0505/3 SBS
Natural bristles, goat hair (ZHW)											
5	5	3	8	-	-	45	4,000 – 10,000	25,000	10	43200359	PBU 0505/3 ZHW



Miniature brushes

Cup brushes, crimped

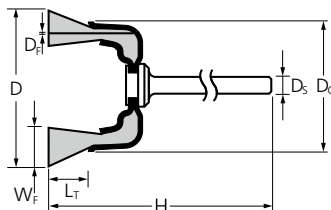

TBU

Suitable for light brushing such as deburring, cleaning and polishing. Particularly suitable for brushing on small surfaces due to face-down use with the entire brush face applied to the workpiece. They can be used on flexible shaft drives, micro motors or electric grinders.

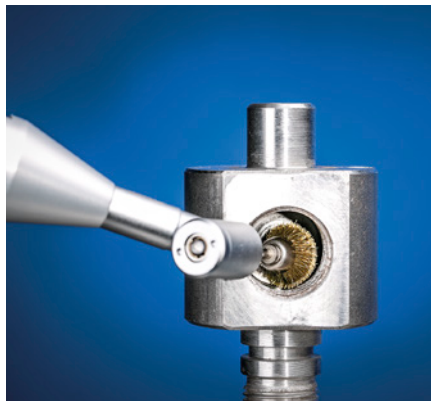

Special features:

- Maximum precision and efficiency in work on delicate workpieces.
- Highly flexible, enabling optimal adjustment to the workpiece contour.
- Creates fine surfaces.

D [mm]	D _c [mm]	D _s [mm]	W _f [mm]	L _t [mm]	Grit size	D _f [mm]	H [mm]	Opt. RPM	Max. RPM		Item no.	Designation
Steel wire (ST)												
15	8	3	3	5	-	0.10	45	5,000 – 10,000	20,000	10	43209251	TBU 1503/3 ST 0,10
18	10	3	3	6	-	0.10	45	5,000 – 10,000	18,000	10	43209451	TBU 1803/3 ST 0,10
Stainless steel wire (INOX)												
15	8	3	3	5	-	0.10	45	4,000 – 10,000	20,000	10	43209252	TBU 1503/3 INOX 0,10
18	10	3	3	6	-	0.10	45	4,000 – 10,000	18,000	10	43209452	TBU 1803/3 INOX 0,10
Brass wire (MES)												
15	8	3	3	5	-	0.10	45	4,000 – 10,000	20,000	10	43209253	TBU 1503/3 MES 0,10
18	10	3	3	6	-	0.10	45	4,000 – 10,000	18,000	10	43209453	TBU 1803/3 MES 0,10
Silicon carbide (SiC) plastic filament												
18	10	3	3	6	320	0.55	45	1,200 – 5,000	18,000	10	43209454	TBU 1803/3 SiC 320 0,55
					800	0.25	45	1,200 – 5,000	18,000	10	43209455	TBU 1803/3 SiC 800 0,25
Aluminium oxide (AO) plastic filament												
18	10	3	3	6	320	0.50	45	1,200 – 5,000	18,000	10	43209461	TBU 1803/3 AO 320 0,50
		2.34	3	6	600	0.30	45	1,200 – 5,000	18,000	10	43209410	TBU 1803/2,34 AO 600 0,30
		3	3	6	600	0.30	45	1,200 – 5,000	18,000	10	43209460	TBU 1803/3 AO 600 0,30
Diamond (DIA) plastic filament												
18	10	3	3	6	400	0.40	45	4,000 – 10,000	18,000	10	47701648	TBU 1803/3 DIA 400 0,40
Nylon plastic filament												
15	8	3	3	5	-	0.15	45	1,200 – 5,000	20,000	10	43209256	TBU 1503/3 Nylon 0,15
18	10	3	3	6	-	0.15	45	1,200 – 5,000	18,000	10	43209456	TBU 1803/3 Nylon 0,15
Natural bristles, white bristle (SBW)												
15	8	3	3	5	-	-	45	4,000 – 10,000	20,000	10	43209257	TBU 1503/3 SBW
18	10	3	3	6	-	-	45	4,000 – 10,000	18,000	10	43209457	TBU 1803/3 SBW

Continued on next page

Miniature brushes

Cup brushes, crimped

D [mm]	D _C [mm]	D _S [mm]	W _F [mm]	L _T [mm]	Grit size	D _F [mm]	H [mm]	Opt. RPM	Max. RPM		Item no.	Designation
Natural bristles, black bristle (SBS)												
15	8	3	3	5	-	-	45	4,000 – 10,000	20,000	10	43209258	TBU 1503/3 SBS
18	10	3	3	6	-	-	45	4,000 – 10,000	18,000	10	43209458	TBU 1803/3 SBS
Natural bristles, goat hair (ZHW)												
15	8	3	3	5	-	-	45	4,000 – 10,000	20,000	10	43209259	TBU 1503/3 ZHW
18	10	3	3	6	-	-	45	4,000 – 10,000	18,000	10	43209459	TBU 1803/3 ZHW

Wheel brushes, crimped

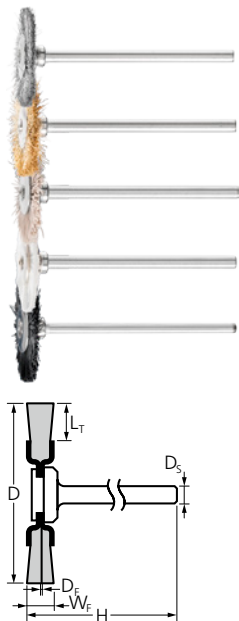

RBU

Suitable for light brushing such as deburring, cleaning and polishing. Miniature brushes can be used on flexible shaft drives, micro motors or electric grinders.



Special features:

- Maximum precision and efficiency in work on delicate workpieces.
- Enables focused working in hard-to-reach areas.
- Creates fine surfaces.

D [mm]	W _F [mm]	D _S [mm]	L _T [mm]	Grit size	D _F [mm]	H [mm]	Opt. RPM	Max. RPM		Item no.	Designation
Steel wire (ST)											
16	2	3	3	-	0.10	46	5,000 – 10,000	12,000	10	43100351	RBU 1602/3 ST 0,10
19	2	3	5	-	0.10	46	5,000 – 10,000	12,000	10	43100551	RBU 1902/3 ST 0,10
22	2	3	6	-	0.10	46	5,000 – 10,000	12,000	10	43100751	RBU 2202/3 ST 0,10
32	2	3	10	-	0.10	46	5,000 – 10,000	12,000	10	43102051	RBU 3202/3 ST 0,10

Stainless steel wire (INOX)											
16	2	3	3	-	0.10	46	4,000 – 10,000	12,000	10	43100352	RBU 1602/3 INOX 0,10
19	2	3	5	-	0.10	46	4,000 – 10,000	12,000	10	43100552	RBU 1902/3 INOX 0,10
22	2	3	6	-	0.10	46	4,000 – 10,000	12,000	10	43100752	RBU 2202/3 INOX 0,10
32	2	3	10	-	0.10	46	4,000 – 10,000	12,000	10	43102053	RBU 3202/3 INOX 0,10

Brass wire (MES)											
16	2	3	3	-	0.10	46	4,000 – 10,000	12,000	10	43100353	RBU 1602/3 MES 0,10
19	2	3	5	-	0.10	46	4,000 – 10,000	12,000	10	43100553	RBU 1902/3 MES 0,10
22	2	3	6	-	0.10	46	4,000 – 10,000	12,000	10	43100753	RBU 2202/3 MES 0,10

Continued on next page

D [mm]	W _f [mm]	D _s [mm]	L _f [mm]	Grit size	D _f [mm]	H [mm]	Opt. RPM	Max. RPM		Item no.	Designation
Silicon carbide (SiC) plastic filament											
22	2	3	6	320	0.55	46	1,200 – 5,000	12,000	10	43100754	RBU 2202/3 SiC 320 0,55
				800	0.25	46	1,200 – 5,000	12,000	10	43100755	RBU 2202/3 SiC 800 0,25
Aluminium oxide (AO) plastic filament											
22	2	3	6	320	0.50	46	1,200 – 5,000	12,000	10	43100760	RBU 2202/3 AO 320 0,50
				600	0.30	46	1,200 – 5,000	12,000	10	43100761	RBU 2202/3 AO 600 0,30
Diamond (DIA) plastic filament											
22	2	3	6	400	0.40	46	1,200 – 5,000	12,000	10	47701642	RBU 2202/3 DIA 400 0,40
Nylon plastic filament											
22	2	3	6	-	0.15	46	1,200 – 5,000	12,000	10	43100756	RBU 2202/3 Nylon 0,15
Natural bristles, white bristle (SBW)											
16	2	2.34	3	-	-	46	4,000 – 10,000	12,000	10	43100307	RBU 1602/2,34 SBW
		3	3	-	-	46	4,000 – 10,000	12,000	10	43100357	RBU 1602/3 SBW
19	2	2.34	5	-	-	46	4,000 – 10,000	12,000	10	43100507	RBU 1902/2,34 SBW
		3	5	-	-	46	4,000 – 10,000	12,000	10	43100557	RBU 1902/3 SBW
22	2	3	6	-	-	46	4,000 – 10,000	12,000	10	43100757	RBU 2202/3 SBW
Natural bristles, black bristle (SBS)											
16	2	3	3	-	-	46	4,000 – 10,000	12,000	10	43100358	RBU 1602/3 SBS
19	2	3	5	-	-	46	4,000 – 10,000	12,000	10	43100558	RBU 1902/3 SBS
22	2	3	6	-	-	46	4,000 – 10,000	12,000	10	43100758	RBU 2202/3 SBS
Natural bristles, goat hair (ZHW)											
16	2	3	3	-	-	46	4,000 – 10,000	12,000	10	43100359	RBU 1602/3 ZHW
22	2	3	6	-	-	46	4,000 – 10,000	12,000	10	43100759	RBU 2202/3 ZHW

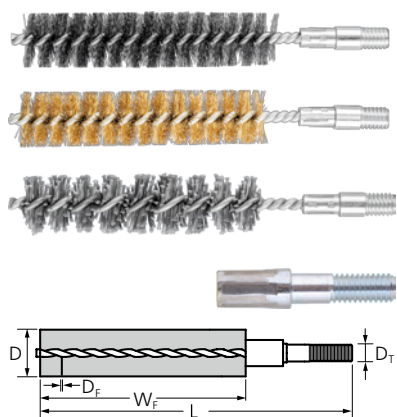

IBU, with thread

Particularly suitable for deburring and cleaning pipes, threads, coupling sleeves and cylinders.



Special features:

- Can be clamped in collets thanks to integrated shank (M6 = 6 mm and 3/8 = 10 mm).
- Creates fine surfaces.

D [mm]	W _F [mm]	D _T [mm]	Grit size	D _F [mm]	L [mm]	Max. RPM		Item no.	Designation
Steel wire (ST)									
8	80	M6	-	0.15	120	1,000	10	43679001	IBU 0880/M6 ST 0,15
10	80	M6	-	0.15	120	1,000	10	43679011	IBU 1080/M6 ST 0,15
12	80	M6	-	0.15	120	1,000	10	43679021	IBU 1280/M6 ST 0,15
13	80	M6	-	0.20	120	1,000	10	43679031	IBU 1380/M6 ST 0,20
15	80	M6	-	0.20	120	1,000	10	43679041	IBU 1580/M6 ST 0,20
16	80	M6	-	0.20	120	1,000	10	43679051	IBU 1680/M6 ST 0,20
18	80	M6	-	0.20	120	1,000	10	43679061	IBU 1880/M6 ST 0,20
20	80	M6	-	0.20	120	1,000	10	43679071	IBU 2080/M6 ST 0,20
22	100	3/8 BSW	-	0.20	170	1,000	10	43679081	IBU 22100/3/8 BSW ST 0,20
25	100	3/8 BSW	-	0.20	170	1,000	10	43679091	IBU 25100/3/8 BSW ST 0,20
30	100	3/8 BSW	-	0.20	170	1,000	10	43679101	IBU 30100/3/8 BSW ST 0,20
32	100	1/2 BSW	-	0.25	170	1,000	10	43679111	IBU 32100/1/2 BSW ST 0,25
38	100	1/2 BSW	-	0.30	170	1,000	10	43679121	IBU 38100/1/2 BSW ST 0,30
40	100	1/2 BSW	-	0.30	170	1,000	10	43679131	IBU 40100/1/2 BSW ST 0,30
44	100	1/2 BSW	-	0.30	170	1,000	10	43679141	IBU 44100/1/2 BSW ST 0,30
50	100	1/2 BSW	-	0.35	170	1,000	5	43679151	IBU 50100/1/2 BSW ST 0,35
57	100	1/2 BSW	-	0.35	170	1,000	5	43679161	IBU 57100/1/2 BSW ST 0,35
63	100	1/2 BSW	-	0.35	170	1,000	5	43679171	IBU 63100/1/2 BSW ST 0,35
69	100	1/2 BSW	-	0.35	170	1,000	5	43679181	IBU 69100/1/2 BSW ST 0,35
75	100	1/2 BSW	-	0.35	170	1,000	1	43679191	IBU 75100/1/2 BSW ST 0,35
82	100	1/2 BSW	-	0.35	170	1,000	1	43679301	IBU 82100/1/2 BSW ST 0,35
101	100	1/2 BSW	-	0.50	170	1,000	1	43679311	IBU 101100/1/2 BSW ST 0,50

Stainless steel wire (INOX)

8	80	M6	-	0.15	120	1,000	10	43679003	IBU 0880/M6 INOX 0,15
10	80	M6	-	0.15	120	1,000	10	43679013	IBU 1080/M6 INOX 0,15
12	80	M6	-	0.15	120	1,000	10	43679023	IBU 1280/M6 INOX 0,15
13	80	M6	-	0.20	120	1,000	10	43679033	IBU 1380/M6 INOX 0,20
15	80	M6	-	0.20	120	1,000	10	43679043	IBU 1580/M6 INOX 0,20
16	80	M6	-	0.20	120	1,000	10	43679053	IBU 1680/M6 INOX 0,20
18	80	M6	-	0.20	120	1,000	10	43679063	IBU 1880/M6 INOX 0,20
20	80	M6	-	0.20	120	1,000	10	43679073	IBU 2080/M6 INOX 0,20
22	100	3/8 BSW	-	0.20	170	1,000	10	43679083	IBU 22100/3/8 BSW INOX 0,20
25	100	3/8 BSW	-	0.20	170	1,000	10	43679093	IBU 25100/3/8 BSW INOX 0,20
30	100	3/8 BSW	-	0.20	170	1,000	10	43679103	IBU 30100/3/8 BSW INOX 0,20
32	100	1/2 BSW	-	0.25	170	1,000	10	43679113	IBU 32100/1/2 BSW INOX 0,25
38	100	1/2 BSW	-	0.30	170	1,000	10	43679123	IBU 38100/1/2 BSW INOX 0,30
40	100	1/2 BSW	-	0.30	170	1,000	10	43679133	IBU 40100/1/2 BSW INOX 0,30
44	100	1/2 BSW	-	0.30	170	1,000	10	43679143	IBU 44100/1/2 BSW INOX 0,30

Continued on next page

D [mm]	W _F [mm]	D _r [mm]	Grit size	D _f [mm]	L [mm]	Max. RPM		Item no.	Designation
Brass wire (MES)									
8	80	M6	-	0.15	120	1,000	10	43679002	IBU 0880/M6 MES 0,15
10	80	M6	-	0.15	120	1,000	10	43679012	IBU 1080/M6 MES 0,15
12	80	M6	-	0.15	120	1,000	10	43679022	IBU 1280/M6 MES 0,15
13	80	M6	-	0.20	120	1,000	10	43679032	IBU 1380/M6 MES 0,20
15	80	M6	-	0.20	120	1,000	10	43679042	IBU 1580/M6 MES 0,20
16	80	M6	-	0.20	120	1,000	10	43679052	IBU 1680/M6 MES 0,20
18	80	M6	-	0.20	120	1,000	10	43679062	IBU 1880/M6 MES 0,20
20	80	M6	-	0.20	120	1,000	10	43679072	IBU 2080/M6 MES 0,20
22	100	3/8 BSW	-	0.20	170	1,000	10	43679082	IBU 22100/3/8 BSW MES 0,20
25	100	3/8 BSW	-	0.20	170	1,000	10	43679092	IBU 25100/3/8 BSW MES 0,20
30	100	3/8 BSW	-	0.20	170	1,000	10	43679102	IBU 30100/3/8 BSW MES 0,20
32	100	1/2 BSW	-	0.25	170	1,000	10	43679112	IBU 32100/1/2 BSW MES 0,25
38	100	1/2 BSW	-	0.30	170	1,000	10	43679122	IBU 38100/1/2 BSW MES 0,30
40	100	1/2 BSW	-	0.30	170	1,000	10	43679132	IBU 40100/1/2 BSW MES 0,30
44	100	1/2 BSW	-	0.30	170	1,000	10	43679142	IBU 44100/1/2 BSW MES 0,30

Silicon carbide (SiC) 180 plastic filament

8	80	M6	180	1.00	120	1,000	10	43679004	IBU 0880/M6 SiC 180 1,00
10	80	M6	180	1.00	120	1,000	10	43679014	IBU 1080/M6 SiC 180 1,00
12	80	M6	180	1.00	120	1,000	10	43679024	IBU 1280/M6 SiC 180 1,00
13	80	M6	180	1.00	120	1,000	10	43679034	IBU 1380/M6 SiC 180 1,00
15	80	M6	180	1.00	120	1,000	10	43679044	IBU 1580/M6 SiC 180 1,00
16	80	M6	180	1.00	120	1,000	10	43679054	IBU 1680/M6 SiC 180 1,00
18	80	M6	180	1.00	120	1,000	10	43679064	IBU 1880/M6 SiC 180 1,00
20	80	M6	180	1.00	120	1,000	10	43679074	IBU 2080/M6 SiC 180 1,00
22	100	3/8 BSW	180	1.00	170	1,000	10	43679084	IBU 22100/3/8 BSW SiC 180 1,00
25	100	3/8 BSW	180	1.00	170	1,000	10	43679094	IBU 25100/3/8 BSW SiC 180 1,00
30	100	3/8 BSW	180	1.00	170	1,000	10	43679104	IBU 30100/3/8 BSW SiC 180 1,00

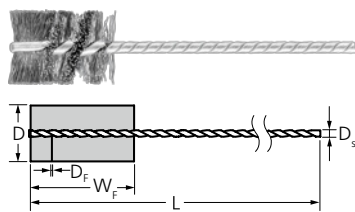

IBU, shank-mounted

For light cleaning and deburring work on threaded holes or recesses, e.g. keyways. With tube brushes with a short eyelet, the filament reaches up to the tip of the brush.

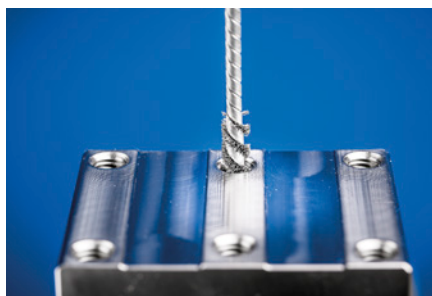

Special features:

- Highly flexible, enabling optimal adjustment to the workpiece contour. Creates fine surfaces.
- Longer tool life due to the design of the stem.
- The bent end of the wire does not have any sharp edges, which prevents delicate surfaces from getting scratched.

D [mm]	W _F [mm]	D _s [mm]	D _f [mm]	L [mm]	Max. RPM		Item no.	Designation
Steel wire (ST)								
6	25	3.2	0.12	90	3,500	10	43679601	IBU 0625/3,2 ST 0,12
8	25	3.2	0.12	90	3,500	10	43679611	IBU 0825/3,2 ST 0,12
10	25	3.2	0.12	90	3,500	10	43679621	IBU 1025/3,2 ST 0,12
			0.20	90	3,500	10	43679631	IBU 1025/3,2 ST 0,20
13	25	3.2	0.12	90	3,500	10	43679641	IBU 1325/3,2 ST 0,12
			0.20	90	3,500	10	43679651	IBU 1325/3,2 ST 0,20

Continued on next page

D [mm]	W _F [mm]	D _S [mm]	D _F [mm]	L [mm]	Max. RPM		Item no.	Designation
16	25	3.2	0.12	90	3,000	10	43679661	IBU 1625/3,2 ST 0,12
			0.20	90	3,000	10	43679671	IBU 1625/3,2 ST 0,20
19	25	3.2	0.12	90	3,000	10	43679681	IBU 1925/3,2 ST 0,12
			0.20	90	3,000	10	43679691	IBU 1925/3,2 ST 0,20
22	25	3.8	0.12	90	3,000	10	43679701	IBU 2225/3,8 ST 0,12
			0.20	90	3,000	10	43679711	IBU 2225/3,8 ST 0,20
25	25	3.8	0.12	90	3,000	10	43679721	IBU 2525/3,8 ST 0,12
			0.20	90	3,000	10	43679731	IBU 2525/3,8 ST 0,20
29	25	3.8	0.20	90	3,000	10	43679741	IBU 2925/3,8 ST 0,20
32	25	3.8	0.20	90	3,000	10	43679751	IBU 3225/3,8 ST 0,20

Stainless steel wire (INOX)

6	25	3.2	0.12	90	3,500	10	43679602	IBU 0625/3,2 INOX 0,12
10	25	3.2	0.12	90	3,500	10	43679622	IBU 1025/3,2 INOX 0,12
13	25	3.2	0.12	90	3,500	10	43679642	IBU 1325/3,2 INOX 0,12
16	25	3.2	0.12	90	3,000	10	43679662	IBU 1625/3,2 INOX 0,12
			0.20	90	3,000	10	43679672	IBU 1625/3,2 INOX 0,20
19	25	3.2	0.12	90	3,000	10	43679682	IBU 1925/3,2 INOX 0,12
			0.20	90	3,000	10	43679692	IBU 1925/3,2 INOX 0,20
22	25	3.8	0.12	90	3,000	10	43679712	IBU 2225/3,8 INOX 0,12
25	25	3.8	0.12	90	3,000	10	43679722	IBU 2525/3,8 INOX 0,12
			0.20	90	3,000	10	43679732	IBU 2525/3,8 INOX 0,20
32	25	3.8	0.20	90	3,000	10	43679752	IBU 3225/3,8 INOX 0,20

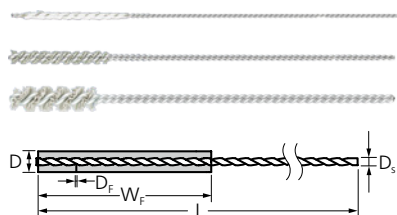

IBU, shank-mounted

For light deburring and cleaning of holes and cross holes and for work on surfaces. With tube brushes with a short eyelet, the filament reaches up to the tip of the brush.

Special features:

- Highly flexible, enabling optimal adjustment to the workpiece contour. Creates fine surfaces.
- Enable maximum precision and efficiency in work on delicate workpieces. The dimensional accuracy of the workpieces remains unchanged.
- The bent end of the wire does not have any sharp edges, which prevents delicate surfaces from getting scratched.

D [mm]	W _F [mm]	D _S [mm]	Grit size	D _F [mm]	L [mm]	Max. RPM		Item no.	Designation
--------	---------------------	---------------------	-----------	---------------------	--------	----------	--	----------	-------------

Aluminium oxide (AO) plastic filament

0.7	12	0.4	2000	0.20	100	1,000	10	43679504	IBU 0,712/0,4 AO 2000 0,20
-----	----	-----	------	------	-----	-------	----	----------	----------------------------

Silicon carbide (SiC) plastic filament

1.2	12	0.5	1000	0.25	100	1,000	10	43679514	IBU 1,212/0,5 SiC 1000 0,25
1.9	18	0.7	1000	0.25	100	1,000	10	43679524	IBU 1,918/0,7 SiC 1000 0,25
2.2	18	0.9	1000	0.25	100	1,000	10	43679534	IBU 2,218/0,9 SiC 1000 0,25
2.6	25	1	1000	0.25	100	1,000	10	43679544	IBU 2,625/1,0 SiC 1000 0,25
3.2	25	1.7	2000	0.25	100	1,000	10	43679554	IBU 3,225/1,7 SiC 1000 0,25
3.5	25	1.7	1000	0.25	100	1,000	10	43679564	IBU 3,525/1,7 SiC 1000 0,25

Aluminium oxide (AO) plastic filament

4.2	25	2.2	600	0.30	125	1,000	10	43679575	IBU 4,225/2,2 AO 600 0,30
4.8	25	2.2	600	0.30	125	1,000	10	43679585	IBU 4,825/2,2 AO 600 0,30
5.5	25	2.2	600	0.30	125	1,000	10	43679595	IBU 5,525/2,2 AO 600 0,30
6.6	25	2.9	600	0.30	125	1,000	10	43679605	IBU 6,625/2,9 AO 600 0,30
8.2	25	2.9	600	0.30	125	2,000	10	43679618	IBU 8,225/2,9 AO 600 0,30

Continued on next page

D [mm]	W _F [mm]	D _S [mm]	Grit size	D _F [mm]	L [mm]	Max. RPM		Item no.	Designation
9.8	25	3.2	600	0.30	125	2,000	10	43679619	IBU 9,825/3,2 AO 600 0,30
11.5	25	3.2	600	0.30	125	2,000	10	43679638	IBU 11,525/3,2 AO 600 0,30
13	25	3.7	600	0.30	125	2,000	10	43679639	IBU 1325/3,7 AO 600 0,30
16	25	3.7	600	0.30	125	2,000	10	43679658	IBU 1625/3,7 AO 600 0,30
20	25	4.7	600	0.30	125	2,000	10	43679698	IBU 2025/4,7 AO 600 0,30
25	25	4.7	600	0.30	125	2,000	10	43679738	IBU 2525/4,7 AO 600 0,30

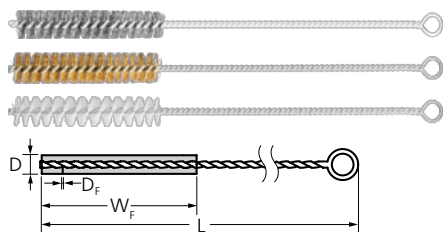

IBU, with eyelet

For light cleaning and deburring work on threaded holes or recesses, e.g. keyways. Specially suited to brushing in manual applications.



Special features:

- Enable maximum precision and efficiency in work on delicate workpieces.
- Optimal access to hard-to-reach areas such as the inner surfaces of pipes and drilled holes.
- Creates fine surfaces.

D [mm]	W _F [mm]	L [mm]	D _F [mm]		Item no.	Designation
-----------	------------------------	-----------	------------------------	--	----------	-------------

Steel wire (ST)

3	100	300	0.10	10	43679401	IBU 03100 ST 0,10
4	100	300	0.15	10	43679411	IBU 04100 ST 0,15
5	100	300	0.15	10	43679421	IBU 05100 ST 0,15
6	100	300	0.15	10	43679201	IBU 06100 ST 0,15
8	100	300	0.15	10	43679211	IBU 08100 ST 0,15
10	100	300	0.15	10	43679221	IBU 10100 ST 0,15
12	100	300	0.15	10	43679231	IBU 12100 ST 0,15
15	100	300	0.15	10	43679241	IBU 15100 ST 0,15
18	100	300	0.15	10	43679481	IBU 18100 ST 0,15
20	100	300	0.15	10	43679251	IBU 20100 ST 0,15
25	100	300	0.15	10	43679261	IBU 25100 ST 0,15
30	100	300	0.15	10	43679271	IBU 30100 ST 0,15

Stainless steel wire (INOX)

3	100	300	0.10	10	43679402	IBU 03100 INOX 0,10
4	100	300	0.15	10	43679412	IBU 04100 INOX 0,15
5	100	300	0.15	10	43679422	IBU 05100 INOX 0,15
6	100	300	0.15	10	43679203	IBU 06100 INOX 0,15
8	100	300	0.15	10	43679213	IBU 08100 INOX 0,15
10	100	300	0.15	10	43679223	IBU 10100 INOX 0,15
12	100	300	0.15	10	43679233	IBU 12100 INOX 0,15
15	100	300	0.15	10	43679243	IBU 15100 INOX 0,15
18	100	300	0.15	10	43679482	IBU 18100 INOX 0,15
20	100	300	0.15	10	43679253	IBU 20100 INOX 0,15
25	100	300	0.15	10	43679263	IBU 25100 INOX 0,15
30	100	300	0.15	10	43679273	IBU 30100 INOX 0,15

Brass wire (MES)

3	100	300	0.10	10	43679403	IBU 03100 MES 0,10
4	100	300	0.15	10	43679413	IBU 04100 MES 0,15

Continued on next page

D [mm]	W _F [mm]	L [mm]	D _F [mm]		Item no.	Designation
5	100	300	0.15	10	43679423	IBU 05100 MES 0,15
6	100	300	0.15	10	43679202	IBU 06100 MES 0,15
8	100	300	0.15	10	43679212	IBU 08100 MES 0,15
10	100	300	0.15	10	43679222	IBU 10100 MES 0,15
12	100	300	0.15	10	43679232	IBU 12100 MES 0,15
15	100	300	0.15	10	43679242	IBU 15100 MES 0,15
18	100	300	0.15	10	43679483	IBU 18100 MES 0,15
20	100	300	0.15	10	43679252	IBU 20100 MES 0,15
25	100	300	0.15	10	43679262	IBU 25100 MES 0,15
30	100	300	0.15	10	43679272	IBU 30100 MES 0,15

Nylon plastic filament

3	100	300	0.10	10	43679404	IBU 03100 Nylon 0,10
4	100	300	0.15	10	43679414	IBU 04100 Nylon 0,15
5	100	300	0.15	10	43679424	IBU 05100 Nylon 0,15
6	100	300	0.15	10	43679206	IBU 06100 Nylon 0,20
8	100	300	0.15	10	43679216	IBU 08100 Nylon 0,20
10	100	300	0.15	10	43679226	IBU 10100 Nylon 0,20
12	100	300	0.15	10	43679236	IBU 12100 Nylon 0,30
15	100	300	0.15	10	43679246	IBU 15100 Nylon 0,30
18	100	300	0.30	10	43679484	IBU 18100 Nylon 0,30
20	100	300	0.15	10	43679256	IBU 20100 Nylon 0,30
25	100	300	0.15	10	43679266	IBU 25100 Nylon 0,30
30	100	300	0.15	10	43679276	IBU 30100 Nylon 0,30

The Universal Line offers a range of brushes in the most common profiles and dimensions. Developed for general and cost-efficient use and for the most common applications. Manufactured to the usual high quality standards according to EN 1083.



Shank-mounted universal cup brushes, crimped



TBU, for power drills

Generally suitable for cleaning, derusting and smoothing, as well as removal of corrosion and paint. Particularly suitable for brushing on large, flat and easily accessible surfaces due to face-down use with the entire brush face applied to the workpiece. Specially developed for use within a low rotational speed range on cordless drills and power drills.

Special features:

- Highly flexible, enabling optimal adjustment to the workpiece contour.
- Creates fine surfaces.

D [mm]	D _s [mm]	Grit size	D _f [mm]	Max. RPM		Item no.	Designation
Steel wire (ST)							
50	6	-	0.30	4,500	1	43740162	POS TBU 50/6 ST 0,30 UNIVERSAL (1)
Stainless steel wire (INOX)							
50	6	-	0.30	4,500	1	43740163	POS TBU 50/6 INOX 0,30 UNIVERSAL (1)
Brass wire (MES)							
50	6	-	0.20	4,500	1	43740164	POS TBU 50/6 MES 0,20 UNIVERSAL (1)
Plastic filament, coarse (RED)							
50	6	80	1.27	4,500	1	43740165	POS TBU 50/6 RED 80 UNIVERSAL (1)
Plastic filament, fine (BLUE)							
50	6	180	1.10	4,500	1	43740166	POS TBU 50/6 BLUE 180 UNIVERSAL (1)

Universal brushes

Shank-mounted universal wheel brushes, crimped

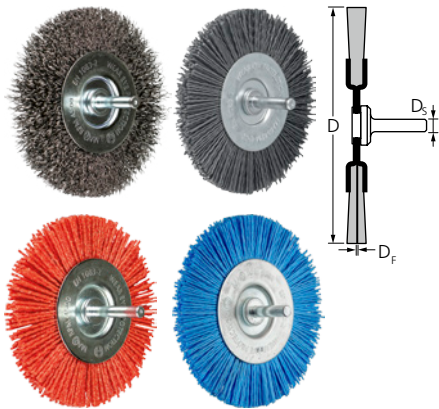

RBU, for power drills

Generally suitable for cleaning, derusting, smoothing, cleaning of weld seams, light deburring, and removal of corrosion and paint. Specially developed for use within a low rotational speed range on cordless drills and power drills.

Special features:

- Highly flexible, enabling optimal adjustment to the workpiece contour.
- Creates fine surfaces.

D [mm]	D _s [mm]	Grit size	D _f [mm]	Max. RPM		Item no.	Designation
Steel wire (ST)							
100	6	-	0.30	4,500	1	43740167	POS RBU 10012/6 ST 0,30 UNIVERSAL (1)
Plastic filament, coarse (RED)							
100	6	80	1.27	4,500	1	43740168	POS RBU 10010/6 RED 80 UNIVERSAL (1)
Plastic filament, fine (BLUE)							
100	6	180	1.10	4,500	1	43740169	POS RBU 10010/6 BLUE 180 UNIVERSAL (1)

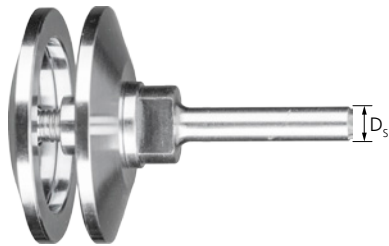

Arbor for wheel brushes

Enable use of wheel brushes with arbor hole on tool drives with collet, e.g. electric straight grinders and flexible shaft drives.

Special features:

- Secure hold of the brush thanks to highly accurate fit.

D_s [mm]	Suitable for brush diameter [mm]	Suitable for hole diameter D_A / D_M [mm]	Suitable for		Item no.	Designation
8	100, 115, 125	12, 14	Wheel brushes RBU	1	43595061	BO 8/12-14 100-125
		22.2	Wheel brushes RBG	1	43595051	BO 8/22,2 100-125
12	150, 180	22.2	Wheel brushes RBU, RBUP and RBG	1	43595062	BO 12/22,2 150-180
	200	22.2	Wheel brushes RBU, RBUP and RBG	1	43595063	BO 12/22,2 200

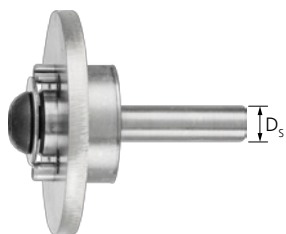

Arbor for composite disc brushes

Enable use of composite disc brushes with arbor hole. Suitable for stationary applications with threaded cup brushes on CNC machines, automated centres and robots.

Special features:

- Secure hold of the brush thanks to highly accurate fit.

D_s [mm]	Suitable for brush diameter [mm]	Suitable for hole diameter D_A / D_M [mm]	Suitable for		Item no.	Designation
12	75–100	22.2	Composite disc brushes DBU	1	43595104	BO 12/22,2 75-100
	125–150	22.2	Composite disc brushes DBU	1	43595105	BO 12/22,2 125-150



Arbor for POLISCRATCH

For mounting POLISCRATCH brushes on straight grinders, flexible shafts or power drills.

Special features:

- Secure hold of the brush thanks to highly accurate fit.

D_T	D_s [mm]	Suitable for		Item no.	Designation
M14x2	8	Wheel brushes RBU, POLISCRATCH	1	43595014	BO 8/M14



Arbor for cup brushes

Enable the use of cup brushes on tool drives with a collet. Also suitable for stationary applications with threaded cup brushes on CNC machines, automated centres and robots. Weldon shank according to DIN 6535.

Special features:

- Secure hold of the brush thanks to highly accurate fit.

D_s [mm]	Suitable for brush diameter [mm]	Suitable for		Item no.	Designation
12	65–80	Cup brushes TBG and TBU	1	79183976	BO 12/SW22 65-80
20	100	Cup brushes TBG and TBU	1	79183977	BO 20/SW27 100

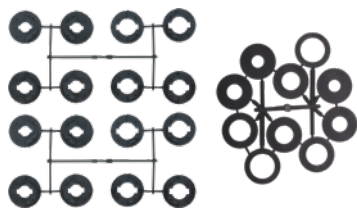

Adapter set AK 32

The adapter set AK 32 is suitable for wheel brushes with a brush diameter from 150 mm in the narrow versions.

Special features:

- Enable the use of brushes on all tool drives as the hole diameter is adjusted to the required dimension.
- Secure hold of the brush thanks to highly accurate fit.

Suitable for	Centre hole dia. D_A included [mm/inch]		Item no.	Designation
RBU, slim type \geq dia. 150 mm	20/18/14/12/25.4 (1)/22.2 (7/8)/16 (5/8)/12.7 (1/2)	1	43690100	AS AK 32



Adapter set AK 32-2

The adapter set AK 32-2 is suitable for wheel brushes with a brush diameter from 150 mm in the wide versions.

Special features:

- Enable the use of brushes on all tool drives as the hole diameter is adjusted to the required dimension.
- Secure hold of the brush thanks to highly accurate fit.

Suitable for	Centre hole dia. D_A included [mm/inch]		Item no.	Designation
RBU, wide type \geq dia. 150 mm	31.75/20/18/14/12/25.4 (1)/22.2 (7/8)/19.2 (3/4)/16 (5/8)/12.7 (1/2)	1	43690102	AS AK 32-2



Adapter pairs AM 50.8-C

The adapter pair AM 50.8-C is suitable for wheel brushes with a brush diameter from 150 mm in the wide and composite versions.

Contents:

An AM 50.8-C set contains 1 adapter pair.

Special features:

- Enable the use of brushes on all tool drives as the hole diameter is adjusted to the required dimension.
- Secure hold of the brush thanks to highly accurate fit.

Suitable for	Centre hole dia. D_A included [mm/inch]		Item no.	Designation
RBU, wide type \geq dia. 150 mm, RBUP, composite type \geq dia. 150 mm	14	1	43690014	AP AM 50,8/14,0
	16	1	43690016	AP AM 50,8/16,0
	20	1	43690020	AP AM 50,8/20,0
	22.2	1	43690022	AP AM 50,8/22,2
	25.4	1	43690025	AP AM 50,8/25,4
	30	1	43690030	AP AM 50,8/30,0
	32	1	43690032	AP AM 50,8/32,0
	35	1	43690033	AP AM 50,8/35,0

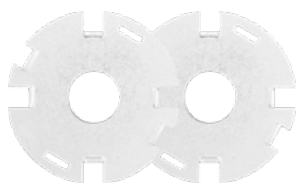

Adapter pair APM 50.8

The adapter pair APM 50.8 is suitable for knotted wheel brushes with diameter 200–250 mm and crimped wheel brushes designed as deburring brushes.

Contents:

An APM 50.8 set contains 3 adapter pairs.

Special features:

- Enable the use of brushes on all tool drives as the hole diameter is adjusted to the required dimension.
- Secure hold of the brush thanks to highly accurate fit.

Suitable for	Centre hole dia. D_A included [mm/inch]		Item no.	Designation
RBG, knotted wheel brushes, dia. 200–250 mm, RBU, deburring brush type dia. 200–250 mm	16/18/20	1	43690035	APM 50,8/16-20
	22.2/25.4/30	1	43690036	APM 50,8/22,2-30
	32/35/40	1	43690037	APM 50,8/32-40

Accessories for tube brushes



Quick-change handle SWG

Suitable for manual work with tube brushes.



Special features:

- Comfortable to use thanks to ergonomic shape.
- Combine with the IBUV extensions in order to access hard-to-reach areas.

L [mm]	Thread		Item no.	Designation
135	M6	1	43690208	SWG-M6
	3/8 BSW	1	43690209	SWG-3/8 BSW
	1/2 BSW	1	43690207	SWG-1/2 BSW
150	Collet 6 mm	1	43690210	SWG-6

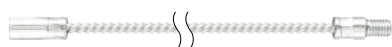

IBUV extension

Suitable for work with tube brushes with a thread.

Special features:

- Optimal access to hard-to-reach areas.
- To achieve a longer overall length, combine the IBUV extensions with the IBUS wire stems or with the SWG quick-change handles.

L [mm]	Thread	Outer dia. of screw socket [mm]		Item no.	Designation
300	M6	12	1	43690211	IBUV M6 300
	3/8 BSW	12	1	43690212	IBUV 3/8 BSW 300
	1/2 BSW	16	1	43690203	IBUV 1/2 BSW 300
1,000	M6	12	1	43690200	IBUV M6 1000
	3/8 BSW	12	1	43690201	IBUV 3/8 BSW 1000
	1/2 BSW	16	1	43690202	IBUV 1/2 BSW 1000

Accessories

Accessories for tube brushes

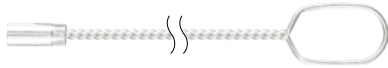

IBUS wire stem

Suitable for work with tube brushes with a thread.

Special features:

- Optimal access to hard-to-reach areas.
- To achieve a longer overall length, combine the IBUS wire stem with the IBUV extensions.

L [mm]	Thread	Outer dia. of screw socket [mm]		Item no.	Designation
300	M6	12	1	43690213	IBUS M6 300
	3/8 BSW	12	1	43690214	IBUS 3/8 BSW 300
	1/2 BSW	16	1	43690215	IBUS 1/2 BSW 300
1,000	M6	12	1	43690204	IBUS M6 1000
	3/8 BSW	12	1	43690205	IBUS 3/8 BSW 1000
	1/2 BSW	16	1	43690216	IBUS 1/2 BSW 1000

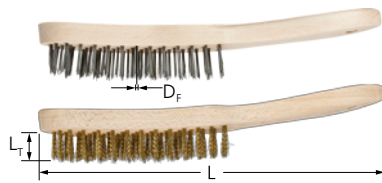

HBU, universal use

Generally suitable for all light cleaning and derusting work.



Special features:

- Optimum presentation on the PFERD TOOLS CENTER using hanging hole and labelling with EAN number, designation and filament material.

Rows	L _T [mm]	L [mm]	D _F [mm]		Item no.	Designation
------	------------------------	-----------	------------------------	---	----------	-------------

Steel wire (ST)

1	25	290	0.35	10	43670011	HBU 10 ST 0,35
2	25	290	0.35	10	43671001	HBU 20 ST 0,35
3	25	290	0.35	50	43672004	HBU 30 GP ST 0,35
				10	43672001	HBU 30 ST 0,35
4	25	290	0.35	50	43673004	HBU 40 GP ST 0,35
				10	43673001	HBU 40 ST 0,35
5	25	290	0.35	50	43670004	HBU 50 GP ST 0,35
				10	43670001	HBU 50 ST 0,35
6	25	290	0.35	10	43673111	HBU 60 ST 0,35

Stainless steel wire (INOX)

1	25	290	0.30	10	43670013	HBU 10 INOX 0,30
2	25	290	0.30	10	43671003	HBU 20 INOX 0,30
3	25	290	0.30	10	43672003	HBU 30 INOX 0,30
4	25	290	0.30	50	43673005	HBU 40 GP INOX 0,30
				10	43673003	HBU 40 INOX 0,30
5	25	290	0.30	10	43670003	HBU 50 INOX 0,30
6	25	290	0.35	10	43673113	HBU 60 INOX 0,30

Brass wire (MES)

2	25	290	0.30	10	43671002	HBU 20 MES 0,30
3	25	290	0.30	10	43672002	HBU 30 MES 0,30
4	25	290	0.30	10	43673002	HBU 40 MES 0,30
5	25	290	0.30	10	43670002	HBU 50 MES 0,30

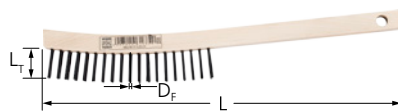

HBU LH, Long Handle

Suitable for cleaning, derusting, and cleaning of weld seams and surfaces. Extra-long handle.

Special features:

- Optimum presentation on the PFERD TOOLS CENTER using hanging hole and labelling with EAN number, designation and filament material.

Rows	L _T [mm]	L [mm]	D _F [mm]		Item no.	Designation
------	------------------------	-----------	------------------------	---	----------	-------------

Steel wire (ST)

3	25	350	0.35	10	43672011	HBU LH 30 ST 0,35
4	25	350	0.35	10	43673011	HBU LH 40 ST 0,35



HBK, for fillet welds

Suitable for cleaning and derusting fillet welds and V-shaped welds thanks to the V shape.



Special features:

- Optimum presentation on the PFERD TOOLS CENTER using hanging hole and labelling with EAN number, designation and filament material.

Rows	L _r [mm]	L [mm]	D _f [mm]		Item no.	Designation
Steel wire (ST)						
3	35	290	0.35	10	43676001	HBK 30 ST 0,35
Stainless steel wire (INOX)						
3	35	290	0.35	10	43676003	HBK 30 INOX 0,35

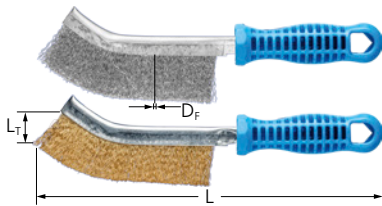

HBG, curved

Excellent for cleaning work in hard-to-reach areas, e.g. angles, corners and pipes.



Special features:

- Optimum presentation on the PFERD TOOLS CENTER using hanging hole and labelling with EAN number, designation and filament material.

Rows	L _r [mm]	L [mm]	D _f [mm]		Item no.	Designation
Steel wire (ST) – ST = brass-plated steel wire						
1	25	265	0.30	10	43660001	HBG 10 ST 0,30
Stainless steel wire (INOX)						
1	25	265	0.30	10	43662003	HBG 10 INOX 0,30
Brass wire (MES)						
1	25	265	0.30	10	43662002	HBG 10 MES 0,30

Scratch brushes

Scratch brushes

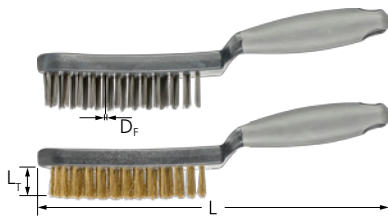

HBUP, plastic body

Generally suitable for all light cleaning and derusting work.

Special features:

- Safe and ergonomic working thanks to curved two-component handle.
- Optimum presentation on the PFERD TOOLS CENTER using hanging hole and labelling with EAN number, designation and filament material.

Rows	L _T [mm]	L [mm]	D _F [mm]		Item no.	Designation
------	------------------------	-----------	------------------------	---	----------	-------------

Steel wire (ST)

3	25	290	0.40	10	43674503	HBUP 30 ST 0,40
4	25	290	0.40	10	43674504	HBUP 40 ST 0,40

Stainless steel wire (INOX)

2	25	290	0.40	10	43674510	HBUP 20 INOX 0,40
3	25	290	0.40	10	43674511	HBUP 30 INOX 0,40
4	25	290	0.40	10	43674512	HBUP 40 INOX 0,40

Brass wire (MES)

3	25	290	0.30	10	43674507	HBUP 30 MES 0,30
4	25	290	0.30	10	43674508	HBUP 40 MES 0,30



HBZ, for spark plugs

Particularly well suited to cleaning spark plugs, small workpieces and tools.

Special features:

- Excellent for the precise cleaning of small weld seams.
- Optimum presentation on the PFERD TOOLS CENTER using hanging hole and labelling with EAN number, designation and filament material.

Rows	L _T [mm]	L [mm]	D _F [mm]		Item no.	Designation
------	------------------------	-----------	------------------------	---	----------	-------------

Brass wire (MES)

3	15	145	0.15	10	43677002	HBZ 30 MES 0,15
---	----	-----	------	----	----------	-----------------



HBB, block brushes with a handle

Robust block brush made from wood for heavy-duty cleaning work.

Special features:

- Excellent for cleaning concrete mouldings.
- Ergonomic working thanks to curved handle.

Rows	L _T [mm]	L [mm]	D _F [mm]		Item no.	Designation
------	------------------------	-----------	------------------------	---	----------	-------------

Steel wire (ST)

8	35	235	0.45	12	43678003	HBB 80 ST 0,45
---	----	-----	------	----	----------	----------------

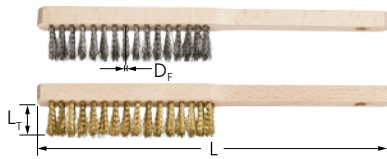

HBFM, for precision mechanics

Excellent for light brushing on fine surfaces.



Special features:

- Optimum presentation on the PFERD TOOLS CENTER using hanging hole and labelling with EAN number, designation and filament material.

Rows	L _r [mm]	L [mm]	D _f [mm]		Item no.	Designation
Steel wire (ST)						
4	20	220	0.15	10	43674001	HBFM 40 ST 0,15
Stainless steel wire (INOX)						
4	20	220	0.15	10	43674003	HBFM 40 INOX 0,15
Brass wire (MES)						
4	20	220	0.15	10	43674002	HBFM 40 MES 0,15

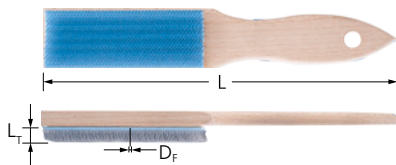

HBF, for files

The file brush effortlessly cleans chips from a clogged file.

Special features:

- Optimum presentation on the PFERD TOOLS CENTER using hanging hole and labelling with EAN number, designation and filament material.

Rows	L _r [mm]	L [mm]	D _f [mm]		Item no.	Designation
Steel wire (ST)						
1	7	232	0.30	5	12601000	HBF 10 ST 0,30