

**PFERD**

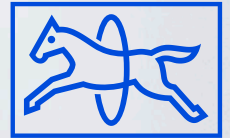

**TOOLS**



7



# Cut-off wheels for stationary applications

# Cut-off wheels for stationary applications

## Table of contents

### Cut-off wheels for stationary applications

- Highlights from the PFERD TOOLS range – custom-made products 3
- Highlights from the PFERD TOOLS range 4
- General information 4
- Safety notes 4
- Transport and storage 5
- Product lines and colour coding 6
- The quick way to find the perfect tool 7
- Custom-made products 9



### CHOPSAW cut-off wheels dia. 300–400 mm

- Universal Line PSF ★★★☆☆ 11
- Performance Line SG ★★★★★ 12



### CHOPSAW HD cut-off wheels dia. 300–400 mm

- Performance Line SG ★★★★★ 13



### Laboratory cut-off wheels dia. 150–400 mm

- Performance Line SG ★★★★★ 15



### Rail cut-off wheels dia. 300–400 mm

- Universal Line PSF ★★★☆☆ 16
- Performance Line SG ★★★★★ 16



### HEAVY DUTY cut-off wheels dia. 250–600 mm

- Special Line SGP ★★★★★ 18



### Reducing rings for stationary cut-off wheels

- Reducing rings for stationary cut-off wheels 20



# Cut-off wheels for stationary applications

Highlights from the PFERD TOOLS range – custom-made products



## What is the correct procedure for selecting a stationary cut-off wheel?

Our experienced technical advisers will start by analyzing your current set-up. They will visit you on site to see your machine, application and the wheel dimensions. PFERD TOOLS will determine the wheel thickness based on how thick the wheel needs to be for cutting. The drive output of the machine motor and the diameter of the clamping flange are also important for selecting the right stationary cut-off wheel. Based on this information and other data, we check which customized solution PFERD TOOLS can produce for you.



## What are the operating conditions and which cross sections need to be cut?

In addition to the information about the machine, it is essential to know the operating conditions for the cutting work. A distinction is made between cold (up to 100°), warm (100 to 600°) and hot cutting-off (600 to over 1,000°), depending on the material temperature of the workpieces being cut. The main cutting applications are cross sections measuring 20 mm to 500 mm in a round design, and square designs from 50 mm to 250 mm (depending on the specific requirements and industry), as well as a range of profiles such as various rails. Based on the operating conditions and cross sections, you can determine which wheel diameter is required/recommended.



For medium-sized cut-off wheels the range is 400 – 600 mm (traditional applications in foundries, finishing processes and when cutting to size); for large cut-off wheels the range is 800 – 2,000 mm (applications in rolling mills and forging plants in the steel production industry).

## What are the requirements for the cuts?

A good result for cold cutting-off is that the cut surface is blank (no blue or brown discoloration) and that the cut itself is perpendicular. The heat ingress into the material should also be minimal to prevent hard spots at the ends of the cut, which could cause cracks in the steel.

Ideally, the formation of burrs on the material should be minimized to negate the need for reworking. The blank cut does not play a role in warm and hot cutting-off – the aim here is to ensure a long tool life, a perpendicular cut and a reliable process.



## Customized solutions

Upon request, PFERD TOOLS can manufacture stationary cut-off wheels up to a diameter of 2,000 mm in the excellent PFERD TOOLS quality, specifically for your application. Please contact us for further information. Our experienced technical advisers will be pleased to assist you. Scan the QR code to access the contact form.



# Cut-off wheels for stationary applications

## Highlights from the PFERD TOOLS range



### More expert information online

Scan the QR code to find out a wide range of tool and application knowledge relating to PFERD TOOLS' high-quality tools and their huge variety of materials.

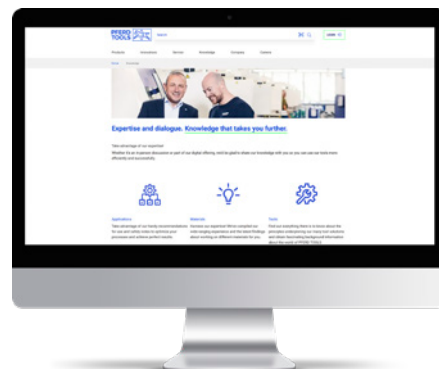

## General information

### Advantages of stationary cut-off grinding

- Universal cutting process for all steels and castings, non-ferrous metal alloys, special alloys such as nickel and titanium-based alloys, as well as materials on which sawing and flame cutting are difficult or impossible.
- Due to smooth cutting surfaces and blank cuts in cold cutting-off, no post-processing is required.
- Short cutting times regardless of the material quality.
- Significantly lower burr formation with hot cutting-off than with hot sawing.
- Lower noise levels than with hot sawing.  
Example:  
Hot cutting-off: 85 to 95 dBA  
Hot sawing: 105 to 110 dBA
- Consistent cutting quality over the entire life of the cut-off wheel due to its continuous self-sharpening qualities.
- Enables cutting of already cooled rolled or forged parts in hot cut lines.

### Applications

Cut-off grinding is one of the most powerful and cost-effective cutting processes and is used in the following areas:

- Rolling mills
- Foundries
- Mechanical engineering
- Steel construction
- Maintenance of rails
- Forging plants and their finishing processes
- Laboratories

## Safety notes

7

### PFERD TOOLS is a founding member of oSa

Together with other renowned manufacturers, PFERD TOOLS has voluntarily undertaken to produce quality tools conforming to the most exacting safety standards. Member companies of oSa (the Organization for the Safety of Abrasives) are committed to continuous product safety and quality monitoring. Products from PFERD TOOLS carry the oSa mark. Scan the QR code for further information.



#### Safety standard:

- PFERD TOOLS cut-off wheels conform to the highest safety requirements and are marked according to EN 12413 for grinding tools made of bonded abrasive.

# Cut-off wheels for stationary applications

## Safety notes

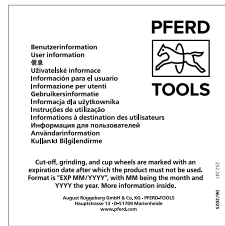

### German Abrasives Association (VDS)

Please observe the safety notes of the German Abrasives Association (VDS). Further information can be found at: [www.pferd.com](http://www.pferd.com)

### User information

Please observe the user information provided with all products on the safe use of stationary cut-off wheels as well as the user information for the grinding machine used.

### FEPA

The FEPA safety recommendations can be downloaded at [www.pferd.com](http://www.pferd.com).

### Proper clamping of cut-off wheels

The correct clamping of the cut-off wheel is a prerequisite for optimum performance and is essential to ensure user safety. The adjacent illustration shows the right way to do it:

- ① Machine spindle with high concentricity.
- ② Equally sized flanges.
- ③ Intermediate paper layers, if required for secure clamping and safe use.

#### Our recommendations:

- After every second wheel change, change the intermediate paper layers.
- As from a wheel diameter > 400 mm, always use intermediate paper layers.

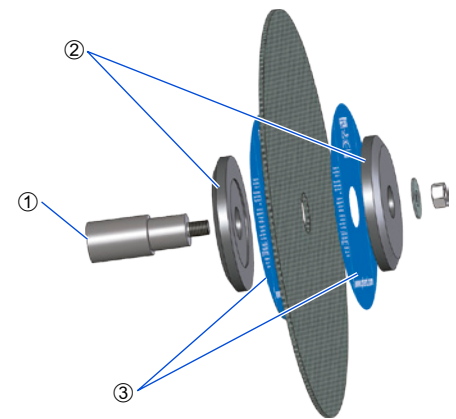

### Safety notes

The safe use of products from PFERD TOOLS depends largely on proper clamping systems. Both flanges between which a grinding tool is mounted must have the same outer diameter and same support area (according to EN 13218, ANSI B7.1).

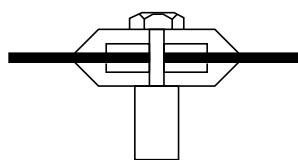

Correct

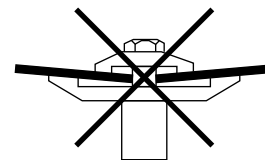

Incorrect

## Transport and storage

### Transport and storage

To avoid damage to the cut-off wheels through improper transport or adverse environmental influences during storage, e.g. UV radiation, temperature or humidity, please observe the following advice:

- As far as possible, transport and store cut-off wheels in their original packaging lying on a flat surface, e.g. on a shelf or vertically in racks.
- Avoid bending the tools.
- Ensure that the cut-off wheels are stored in dry, frost-free rooms with consistent temperatures.
- Use supplies in the order of their arrival.

### Advice on the storage of conical wheels (CT):

Conical cut-off wheels must be stacked with intermediate paper layers, so that the tapered area is supported and bending of the cut-off wheels is avoided.

PFERD TOOLS supplies conical cut-off wheels with intermediate paper layers included.



# Cut-off wheels for stationary applications

Transport and storage

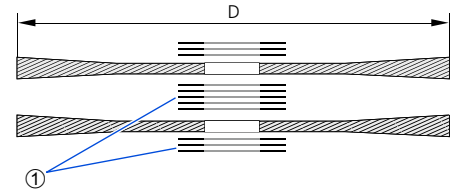
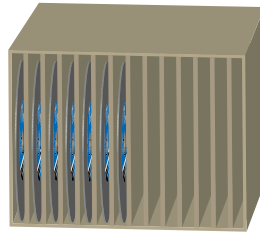
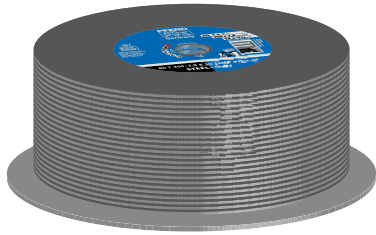

① Intermediate paper layers

## Recommendation



Room temperature: 18-22°C



Relative humidity: 45-65%



No direct sunlight

## Product lines and colour coding



### Universal Line PSF ★★☆☆

The introductory range Universal Line PSF includes **robust tools** for processing the **most common materials**. Universal Line PSF tools achieve **good results** with **high economic efficiency**.



### Performance Line SG ★★★★★

The broad Performance Line SG range offers **a high-performance tool solution for every application and every material**. Performance Line SG tools achieve **optimum results** with **maximum economic efficiency**.



### Special Line SGP ★★★★★

Special Line SGP tools are specially developed for **specific tasks** and offer the user **key advantages over conventional products**. Furthermore, the Special Line SGP includes tools that offer **ultimate economic efficiency** thanks to their particularly high performance during use.



# Cut-off wheels for stationary applications

The quick way to find the perfect tool

## Product labels

### ① oSa – Organization for the Safety of Abrasives

As a founder member of oSa, PFERD TOOLS has voluntarily undertaken to produce quality tools conforming to the most exacting safety standards. Member companies of oSa are committed to continuous product safety and quality monitoring.

### ② Safety information

Handling grinding tools is dangerous. Observe all safety rules and regulations.

### ③ Advice on tool drive

The pictogram shows on which drive the tool can be used.

### ④ Material information

The bottom section of every label indicates the material or materials for which the tool is suitable.

### ⑤ Information bar

Here you will find the product line and the dimensions.

### ⑥ EAN (European Article Number)

### ⑦ Hardness grade

The hardness denotes the strength with which the abrasive grit is held by the bond within the grinding tool. The hardness is indicated with a letter:

K, H = very soft / L, N = soft /

O, P, Q = medium-hard / R, S = hard / T = very hard

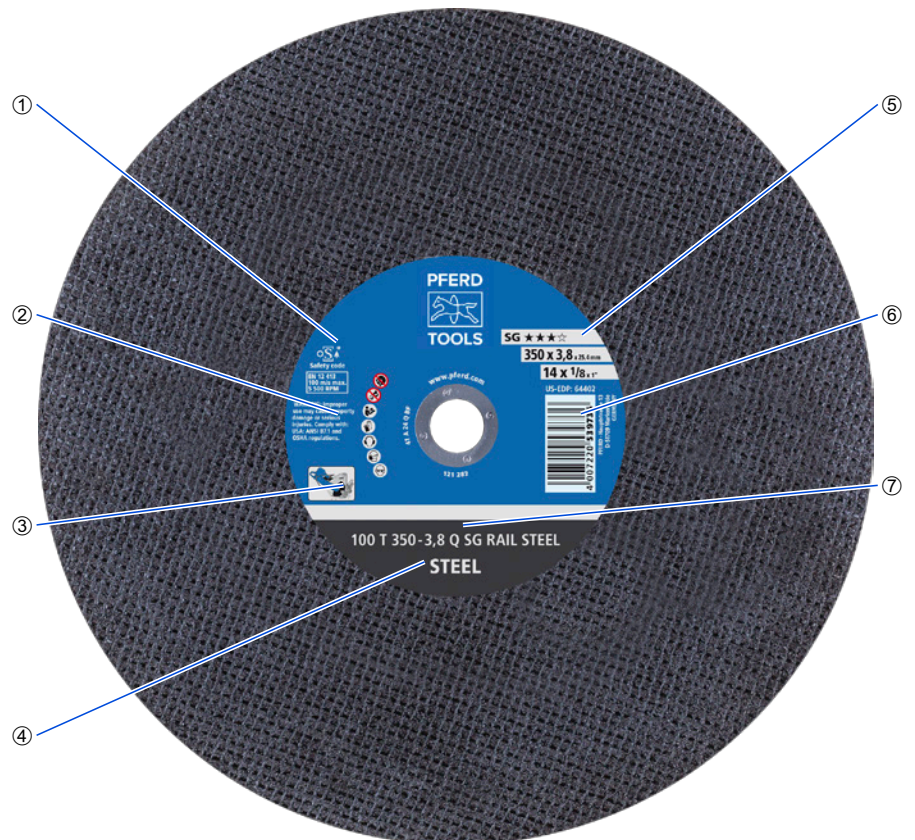







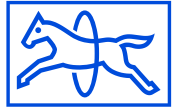



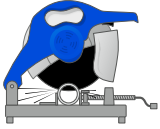





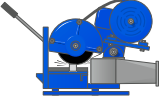



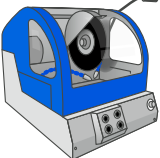

# Cut-off wheels for stationary applications

The quick way to find the perfect tool

**PFERD  
TOOLS**

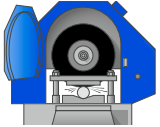
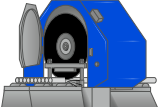

## Product group selection

| Tool drive   | Application  | Product line                       | Steel (STEEL)  |   | Stainless steel (INOX)   | Cast material (CAST)  | Stone (STONE)   |
|--|--|------------------------------------|--|---|--|---|---|
| <b>CHOPSAW</b><br>dia. 300–400 mm<br>12–16" dia.<br>< 3 KW<br>      | Cutting of solid material, profiles and pipes  | <b>Universal Line PSF</b><br>★★☆☆  | <br>PSF CHOP STEEL<br>Hardness K + L          | <br>PSF CHOP STEELOX<br>Hardness K                       | <br>PSF CHOP STEELOX<br>Hardness K          |   |   |
|  |  | <b>Performance Line SG</b><br>★★★☆ | <br>SG CHOP STEEL<br>Hardness K + R           | <br>SG CHOP STEELOX<br>Hardness K + N                    | <br>SG CHOP STEELOX<br>Hardness K + N       |   |   |
| <b>CHOPSAW HD</b><br>dia. 300–400 mm<br>12–16" dia.<br>             | Cutting of solid material, profiles and pipes  | <b>Universal Line PSF</b><br>★★☆☆  | <br>PSF CHOP HD STEEL<br>Hardness K           |   |  |   |   |
|  |  | <b>Performance Line SG</b><br>★★★☆ | <br>SG CHOP HD STEEL<br>Hardness L + O        | <br>SG CHOP HD STEELOX<br>Hardness L                     | <br>SG CHOP HD STEELOX<br>Hardness L        | <br>SG CHOP HD<br>CAST + STONE<br>Hardness L + O         | <br>SG CHOP HD<br>CAST + STONE<br>Hardness L + O |
| <b>LABOR</b><br>dia. 150–400 mm<br>6–16" dia.<br>                 | Producing precision cuts, cutting of laboratory samples  | <b>Performance Line SG</b><br>★★★☆ | <br>SG LAB STEEL<br>Hardness H              | <br>SG LAB HD STEELOX<br>Hardness H, R + T             | <br>SG LAB HD STEELOX<br>Hardness H,R + T |   |   |
|  |  | <b>Universal Line PSF</b><br>★★☆☆  | <br>PSF RAIL STEEL<br>Hardness Q            |   |  |   |   |
| <b>RAIL</b><br>dia. 300–400 mm<br>12–16" dia.<br>                 | Cutting of rails   | <b>Performance Line SG</b><br>★★★☆ | <br>SG RAIL STEEL<br>Hardness Q + R         |   |  |   |   |
|  |  | <b>Special Line SGP</b><br>★★★☆    | <br>SGP HD STEEL<br>Hardness L, N,<br>Q + S | <br>ZIRKON SGP HD<br>CAST + STEEL<br>Hardness P, R + T |  | <br>ZIRKON SGP HD<br>CAST + STEEL<br>Hardness P, R + T |   |
| <b>HEAVY DUTY</b><br>dia. 250–600 mm<br>10–26" dia.<br>           | Cutting of solid material, profiles and pipes  |                                    |  |   |  |   |   |
| <b>Products made to order up to dia. 2,000 mm 10–80" dia.</b><br> | On request, we can produce stationary cut-off wheels in premium PFERD TOOLS quality up to a diameter of 2,000 mm, tailor-made to meet the requirements of your special application. Please contact us for further information. Our experienced technical advisers will be pleased to assist you. |                                    |  |   |  |   |   |



With middle fabric for aggressive cutting with minimized burr formation



With two outer fabrics for high lateral stability

## Dimensions and designs to meet customer requirements

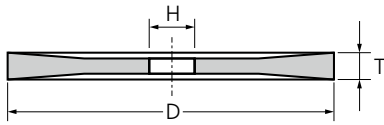

### CT – Conical type

Particularly suitable for use in the steel industry.

**Advantages:**

- Less lateral friction.
- Particularly advantageous for deep cuts and traverse cutting.

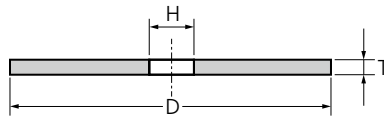

### T – Flat type

Suitable for use in steel and plant construction, in the steel industry and in foundries.

**Advantages:**

- Suitable for universal use.

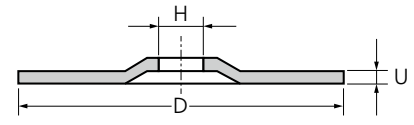

### PT – Depressed-centre type

Particularly suitable for use in foundries.

**Advantages:**

- Clamping flange does not protrude beyond the cut-off wheel.
- Flush cutting of risers from castings is possible.
- In general, no post-processing required.

| Outer dia.<br>D [mm] | Centre hole diameter<br>H [mm]             |
|----------------------|--|
| 2,000                | 80/100/127/152.4/200/<br>203.3/230/280     |
| 1,840                | 80/100/127/152.4/200/<br>203.3/230/280     |
| 1,600                | 80/100/127/152.4/200/<br>203.3/230/280     |
| 1,500                | 80/100/127/152.4/200/<br>203.3/230/280     |
| 1,380                | 80/100/127/152.4/200/<br>203.3/230/280     |
| 1,250                | 80/100/127/152.4/200/<br>203.3/230/250/280 |
| 1,000                | 80/100/127/152.4/200/<br>203.3/230         |
| 800                  | 80/100/127/152.4/200/<br>203.3/230         |

| Outer dia.<br>D [mm] | Centre hole diameter<br>H [mm]     |
|----------------------|------------------------------------|
| 800                  | 80/100/127/152.4/200/<br>203.3/230 |
| 700                  | 80/100/127/152.4/200/<br>203.3/230 |
| 660                  | 25.4/40/60/76.2/80/100             |
| 600                  | 25.4/40/60/76.2/80/100             |
| 500                  | 25.4/40/60/76.2/80/100             |
| 450                  | 25.4/32/40/60/80                   |
| 400                  | 25.4/32/40/60/80                   |
| 350                  | 25.4/32/40                         |
| 300                  | 25.4/32/40                         |
| 250                  | 25.4/30/32                         |

| Outer dia.<br>D [mm] | Centre hole diameter<br>H [mm] |
|----------------------|--------------------------------|
| 800                  | 80/100                         |
| 700                  | 80/100                         |
| 600                  | 60/76.2/80/100                 |
| 500                  | 40/60/76.2/80/100              |
| 400                  | 40/60/80                       |

Other designs and centre hole diameters are available on request. Please contact us for further information.



# Cut-off wheels for stationary applications

Custom-made products



## METALCORE cut-off wheel

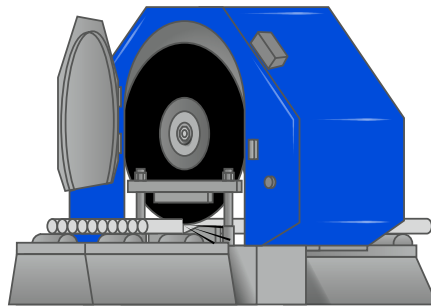

### METALCORE type

The steel-core cut-off wheel developed by PFERD TOOLS is characterized, as compared to the conventional type, by its solid steel body constructed in layers which does not contain any abrasive.

### The tool structure has the following advantages:

- Reduced cutting costs due to the use of smaller clamping flanges.
- Longer tool life.
- Reduced cut-off wheel width for chop stroke cut due to increased lateral stability.
- No cost for the disposal of the old wheel.

### Conventional type

For stationary cut-off grinding, resinoid-bonded, fibre-reinforced cut-off wheels are used, which are essentially composed of four components: abrasive, bond, fabric layers/ flange fabric and active grinding fillers.

## Structure of cut-off wheels

- ① Steel core
- ② Flange fabric
- ③ Fabric layers
- ④ Bonded abrasives

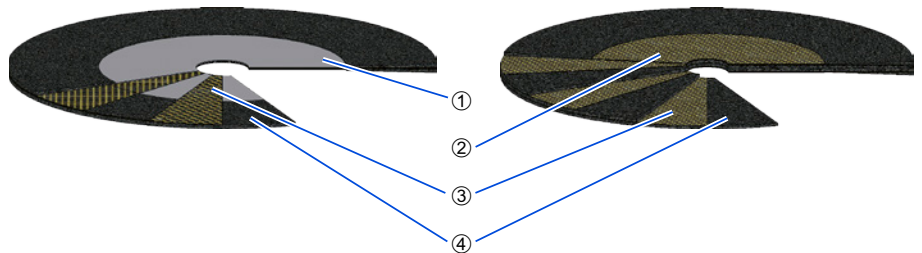

# CHOPSAW cut-off wheels dia. 300–400 mm

Universal Line PSF ★★☆☆



## PSF CHOP STEEL ★★☆☆

Tool which cuts very easily, with a middle fabric for steel. For aggressive cutting with minimal burr formation. Suitable for cutting solid material, profiles and pipes. Suitable tool drives: CHOPSAW up to 3 kW.

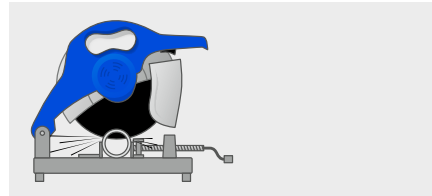

- Fast work progress thanks to good cutting performance.
- Cutting with minimal burr formation due to less lateral friction.

### Special features:

- High economic efficiency due to long tool life.

| Maximum operating speed [m/s]  | D [mm] | T [mm] | H [mm] | Hardness grade | Max. RPM | Abrasive |  | Item no. | Designation                        |
|--------------------------------|--------|--------|--------|----------------|----------|----------|---|----------|------------------------------------|
| <b>Flat design T (type 41)</b> |        |        |        |                |          |          |   |          |                                    |
| 80                             | 300    | 2.8    | 25.4   | K (very soft)  | 5,100    | A        | 20  | 66323074 | 80 T 300-2,8 K PSF CHOP STEEL/25,4 |
|                                | 350    | 2.8    | 25.4   | K (very soft)  | 4,400    | A        | 10  | 66323574 | 80 T 350-2,8 K PSF CHOP STEEL/25,4 |
|                                | 400    | 3.8    | 25.4   | K (very soft)  | 3,800    | A        | 10  | 66324095 | 80 T 400-3,8 K PSF CHOP STEEL/25,4 |



## PSF CHOP STEELOX ★★☆☆

Tool which cuts very easily, with a middle fabric for steel and stainless steel (INOX). For aggressive cutting with minimal burr formation. Suitable for cutting solid material, profiles and pipes. Suitable tool drives: CHOPSAW up to 3 kW.

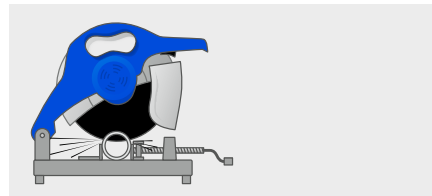

- Fast work progress thanks to high cutting performance.
- Cutting with minimal burr formation due to less lateral friction.

### Special features:

- High economic efficiency due to long tool life.

| Maximum operating speed [m/s]  | D [mm] | T [mm] | H [mm] | Hardness grade | Max. RPM | Abrasive |  | Item no. | Designation                          |
|--------------------------------|--------|--------|--------|----------------|----------|----------|---|----------|--------------------------------------|
| <b>Flat design T (type 41)</b> |        |        |        |                |          |          |   |          |                                      |
| 80                             | 300    | 2.8    | 25.4   | K (very soft)  | 5,100    | A        | 20  | 66323075 | 80 T 300-2,8 K PSF CHOP STEELOX/25,4 |
|                                | 350    | 2.8    | 25.4   | K (very soft)  | 4,400    | A        | 10  | 66323575 | 80 T 350-2,8 K PSF CHOP STEELOX/25,4 |
|                                | 400    | 3.8    | 25.4   | K (very soft)  | 3,800    | A        | 10  | 66324096 | 80 T 400-3,8 K PSF CHOP STEELOX/25,4 |



# CHOPSAW cut-off wheels dia. 300–400 mm

Performance Line SG ★★☆☆



## SG CHOP STEEL ★★☆☆

Tool which cuts very easily, with a middle fabric for steel. For aggressive cutting with minimal burr formation. Suitable for cutting solid material, profiles and pipes. Suitable tool drives: CHOPSAW up to 3 kW.

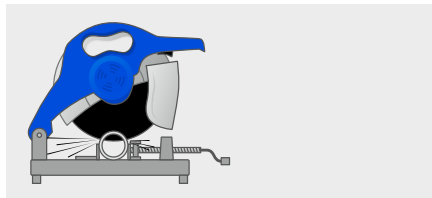

- The fastest work progress thanks to very high cutting performance.
- Cutting with minimal burr formation due to less lateral friction.

### Special features:

- Maximum economic efficiency due to very long tool life.

| Maximum operating speed [m/s]  | D [mm] | T [mm] | H [mm] | Hardness grade | Max. RPM      | Abrasive |    | Item no. | Designation                       |                                   |
|--------------------------------|--------|--------|--------|----------------|---------------|----------|----|----------|-----------------------------------|-----------------------------------|
| <b>Flat design T (type 41)</b> |        |        |        |                |               |          |    |          |                                   |                                   |
| 80                             | 300    | 2.8    | 25.4   | K (very soft)  | 5,100         | A        | 20 | 66323070 | 80 T 300-2,8 K SG CHOP STEEL/25,4 |                                   |
|                                |        |        | 32     | K (very soft)  | 5,100         | A        | 20 | 66323071 | 80 T 300-2,8 K SG CHOP STEEL/32,0 |                                   |
|                                | 350    | 2.8    | 25.4   | K (very soft)  | 4,400         | A        | 10 | 66323570 | 80 T 350-2,8 K SG CHOP STEEL/25,4 |                                   |
|                                |        |        | 32     | K (very soft)  | 4,400         | A        | 10 | 66323571 | 80 T 350-2,8 K SG CHOP STEEL/32,0 |                                   |
|                                | 400    | 3.8    | 25.4   | 25.4           | K (very soft) | 3,800    | A  | 10       | 66324093                          | 80 T 400-3,8 K SG CHOP STEEL/25,4 |
|                                |        |        |        | 32             | K (very soft) | 3,800    | A  | 10       | 66324094                          | 80 T 400-3,8 K SG CHOP STEEL/32,0 |



## SG CHOP STEELOX ★★☆☆

Tool which cuts very easily, with a middle fabric for steel and stainless steel (INOX). For aggressive cutting with minimal burr formation. Suitable for cutting solid material, profiles and pipes. Suitable tool drives: CHOPSAW up to 3 kW.

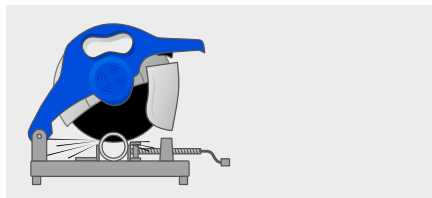

- The fastest work progress thanks to very high cutting performance.
- Cutting with minimal burr formation due to less lateral friction.

### Special features:

- Maximum economic efficiency due to very long tool life.

| Maximum operating speed [m/s]  | D [mm] | T [mm] | H [mm] | Hardness grade | Max. RPM | Abrasive      |       | Item no. | Designation                         |
|--------------------------------|--------|--------|--------|----------------|----------|---------------|-------|----------|-------------------------------------|
| <b>Flat design T (type 41)</b> |        |        |        |                |          |               |       |          |                                     |
| 80                             | 300    | 2.8    | 25.4   | K (very soft)  | 5,100    | A             | 20    | 66323052 | 80 T 300-2,8 K SG CHOP STEELOX/25,4 |
|                                |        |        | 350    | 2.8            | 25.4     | K (very soft) | 4,400 | A        | 10                                  |
|                                | 400    | 2.8    | 25.4   | K (very soft)  | 3,800    | A             | 10    | 66324091 | 80 T 400-2,8 K SG CHOP STEELOX/25,4 |



# CHOPSAW HD cut-off wheels

## dia. 300–400 mm

Performance Line SG ★★☆☆☆



### SG CHOP HD STEEL ★★☆☆☆

Tool with two outer fabrics for steel. For cutting work that requires high stability. Suitable for cutting solid material, profiles and pipes. Suitable tool drives: CHOPSAW HD.

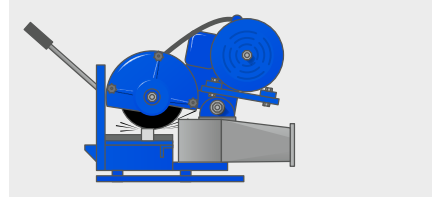

- Maximum economic efficiency due to very long tool life.
- For demanding cutting work.

#### Special features:

- High lateral stability thanks to reinforcing outer fabric.

| Maximum operating speed [m/s]  | D [mm] | T [mm]   | H [mm] | Hardness grade  | Max. RPM | Abrasive |       | Item no. | Designation                           |
|--------------------------------|--------|----------|--------|-----------------|----------|----------|-------|----------|---------------------------------------|
| <b>Flat design T (type 41)</b> |        |          |        |                 |          |          |       |          |                                       |
| 80                             | 300    | 3        | 25.4   | L (soft)        | 5,100    | A        | 20    | 66323080 | 80 T 300-3,0 L SG CHOP HD STEEL/25,4  |
|                                |        |          | 32     | L (soft)        | 5,100    | A        | 20    | 66323081 | 80 T 300-3,0 L SG CHOP HD STEEL/32,0  |
|                                |        | 3.4      | 25.4   | O (medium-hard) | 5,100    | A        | 20    | 66323013 | 80 T 300-3,4 O SG CHOP HD STEEL/25,4  |
|                                |        |          | 350    | 3               | 25.4     | L (soft) | 4,400 | A        | 10                                    |
|                                | 32     | L (soft) |        |                 | 4,400    | A        | 10    | 66323581 | 80 T 350-3,0 L SG CHOP HD STEEL/32,0  |
|                                | 3.8    | 25.4     |        | O (medium-hard) | 4,400    | A        | 10    | 66323513 | 80 T 350-3,8 O SG CHOP HD STEEL/25,4  |
|                                | 400    | 4        | 25.4   | L (soft)        | 3,800    | A        | 10    | 66324080 | 80 T 400-4,0 L SG CHOP HD STEEL/25,4  |
|                                |        |          | 32     | L (soft)        | 3,800    | A        | 10    | 66324081 | 80 T 400-4,0 L SG CHOP HD STEEL/32,0  |
| 100                            | 350    | 4.2      | 25.4   | O (medium-hard) | 5,500    | A        | 10    | 66323613 | 100 T 350-4,2 O SG CHOP HD STEEL/25,4 |



### SG CHOP HD STEELOX ★★☆☆☆

Tool which cuts easily, with two outer fabrics for steel and stainless steel (INOX). For cutting work that requires high stability. Suitable for cutting solid material, profiles and pipes. Suitable tool drives: CHOPSAW HD.

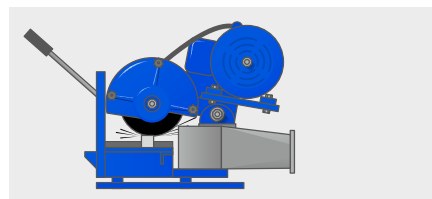

- Maximum economic efficiency due to very long tool life.
- For demanding cutting work.

#### Special features:

- High lateral stability thanks to reinforcing outer fabric.

| Maximum operating speed [m/s]  | D [mm] | T [mm] | H [mm] | Hardness grade | Max. RPM | Abrasive |    | Item no. | Designation                            |
|--------------------------------|--------|--------|--------|----------------|----------|----------|----|----------|--|
| <b>Flat design T (type 41)</b> |        |        |        |                |          |          |    |          |  |
| 80                             | 300    | 3      | 25.4   | L (soft)       | 5,100    | A        | 20 | 66323082 | 80 T 300-3,0 L SG CHOP HD STEELOX/25,4 |
|                                | 350    | 3      | 25.4   | L (soft)       | 4,400    | A        | 10 | 66323582 | 80 T 350-3,0 L SG CHOP HD STEELOX/25,4 |
|                                | 400    | 4      | 25.4   | L (soft)       | 3,800    | A        | 10 | 66324082 | 80 T 400-4,0 L SG CHOP HD STEELOX/25,4 |



# CHOPSAW HD cut-off wheels

## dia. 300–400 mm

Performance Line SG ★★☆☆



### SG CHOP HD CAST + STONE ★★☆☆

Tool which cuts easily, with two outer fabrics for use on cast iron, stone, plastics, aluminium and other non-ferrous metals. Suitable for cutting solid material, profiles and pipes. Suitable tool drives: CHOPSAW HD.

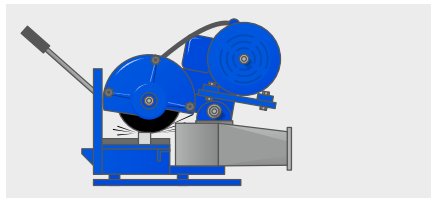

- Maximum economic efficiency due to very long tool life.
- For demanding cutting work.

#### Special features:

- High lateral stability thanks to reinforcing outer fabric.

| Maximum operating speed, max. [m/s] | D [mm] | T [mm] | H [mm] | Hardness grade | Max. RPM | Abrasive |  | Item no. | Designation                               |
|-------------------------------------|--------|--------|--------|----------------|----------|----------|---|----------|---|
| <b>Flat design T (type 41)</b>      |        |        |        |                |          |          |   |          |   |
| 80                                  | 350    | 3.4    | 25.4   | L (soft)       | 4,400    | C        | 10  | 66623583 | 80 T 350-3,4 L SG CHOP HD CAST+STONE/25,4 |
|                                     | 400    | 4      | 25.4   | L (soft)       | 3,800    | C        | 10  | 66624083 | 80 T 400-4,0 L SG CHOP HD CAST+STONE/25,4 |



# Laboratory cut-off wheels dia. 150–400 mm

Performance Line SG ★★☆☆



## SG LAB STEEL ★★☆☆

Tool which cuts very easily, with a middle fabric for steel and cast iron. Suitable for producing precision cuts, fast cutting of lab samples, solid material, profiles and pipes. Suitable tool drives: Lab cutting machine.

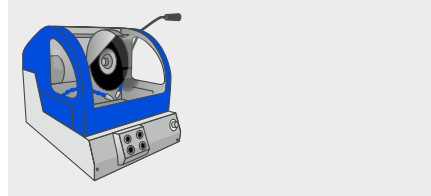

- Safe cutting work thanks to the highest possible cutting quality.
- High stability thanks to reinforcing centre fabric.

### Special features:

- Special tool for metallographic sampling thanks to aggressive abrasive.

| Maximum operating speed [m/s] | D [mm] | T [mm] | H [mm] | Hardness grade | Max. RPM | Abrasive |  | Item no. | Designation |
|-------------------------------|--------|--------|--------|----------------|----------|----------|---|----------|-------------|
|-------------------------------|--------|--------|--------|----------------|----------|----------|---|----------|-------------|

### Flat design T (type 41)

|    |     |     |    |               |       |   |    |          |                                  |
|----|-----|-----|----|---------------|-------|---|----|----------|----------------------------------|
| 80 | 250 | 2   | 32 | H (very soft) | 6,100 | A | 20 | 66300060 | 80 T 250-2,0 H SG LAB STEEL/32,0 |
|    | 300 | 2   | 32 | H (very soft) | 5,100 | A | 20 | 66300100 | 80 T 300-2,0 H SG LAB STEEL/32,0 |
|    | 350 | 2.5 | 32 | H (very soft) | 4,400 | A | 10 | 66300130 | 80 T 350-2,5 H SG LAB STEEL/32,0 |
|    | 400 | 3   | 32 | H (very soft) | 3,800 | A | 10 | 66300150 | 80 T 400-3,0 H SG LAB STEEL/32,0 |



## SG LAB HD STEELOX ★★☆☆

Tool which cuts very easily, with two outer fabrics for steel and stainless steel (INOX). Suitable for producing precision cuts, fast cutting of lab samples, solid material, profiles and pipes. Suitable tool drives: Lab cutting machine.

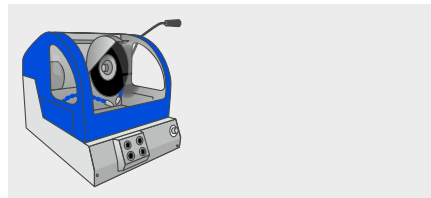

- Safe cutting work thanks to the highest possible cutting quality.
- Very sturdy thanks to reinforcing outer fabric.

### Special features:

- Special tool for metallographic sampling thanks to aggressive abrasive.

| Maximum operating speed [m/s] | D [mm] | T [mm] | H [mm] | Hardness grade | Max. RPM | Abrasive |  | Item no. | Designation |
|-------------------------------|--------|--------|--------|----------------|----------|----------|---|----------|-------------|
|-------------------------------|--------|--------|--------|----------------|----------|----------|---|----------|-------------|

### Flat design T (type 41)

|    |     |     |       |               |        |   |    |          |  |
|----|-----|-----|-------|---------------|--------|---|----|----------|--|
| 80 | 150 | 1   | 22.23 | H (very soft) | 10,200 | A | 25 | 66300010 | 80 T 150-1,0 H SG LAB HD STEELOX/22,23 |
|    | 230 | 1.5 | 22.23 | H (very soft) | 6,600  | A | 25 | 66300030 | 80 T 230-1,5 H SG LAB HD STEELOX/22,23 |



# Rail cut-off wheels dia. 300–400 mm

Universal Line PSF ★★☆☆☆



## PSF RAIL STEEL ★★☆☆☆

Tool for fast and economic cutting of rails. Suitable tool drives: RAIL cutting machine.

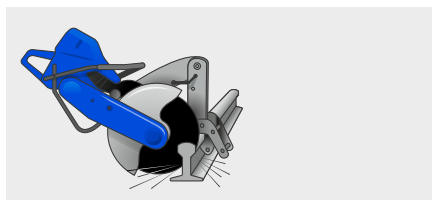

- High economic efficiency due to optimal tool life.

### Special features:

- Fast working progress thanks to aggressive abrasive.
- Safe cutting work thanks to the highest possible cutting quality.

| Maximum operating speed [m/s]  | D [mm] | T [mm] | H [mm]          | Hardness grade  | Max. RPM        | Abrasive |  | Item no.                            | Designation                          |
|--------------------------------|--------|--------|-----------------|-----------------|-----------------|----------|---|-------------------------------------|--------------------------------------|
| <b>Flat design T (type 41)</b> |        |        |                 |                 |                 |          |   |                                     |                                      |
| 100                            | 300    | 3.8    | 22.23           | Q (medium-hard) | 6,400           | A        | 20  | 73001231                            | 100T 300-3.8 Q PSF RAIL STEEL/22.23  |
|                                |        |        | 25.4            | Q (medium-hard) | 5,500           | A        | 10  | 73001322                            | 100 T 350-4,0 Q PSF RAIL STEEL/22,23 |
|                                | 400    | 4      |                 | 25.4            | Q (medium-hard) | 5,500    | A   | 10                                  | 73001230                             |
|                                |        |        | Q (medium-hard) | 4,800           | A               | 10       | 73001310  | 100 T 400-4,0 Q PSF RAIL STEEL/25,4 |                                      |

## Performance Line SG ★★☆☆☆



## SG RAIL STEEL ★★☆☆☆

Tool for fast and economic cutting of rails. Suitable tool drives: RAIL cutting machine.

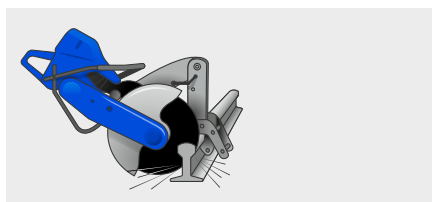

- High economic efficiency due to optimal tool life.

### Special features:

- The fastest work progress thanks to aggressive abrasive.
- Safe cutting work thanks to the highest possible cutting quality.

| Maximum operating speed [m/s]  | D [mm] | T [mm] | H [mm] | Hardness grade  | Max. RPM | Abrasive |  | Item no. | Designation                         |
|--------------------------------|--------|--------|--------|-----------------|----------|----------|---|----------|-------------------------------------|
| <b>Flat design T (type 41)</b> |        |        |        |                 |          |          |   |          |                                     |
| 100                            | 300    | 3.8    | 22.23  | Q (medium-hard) | 6,400    | A        | 20  | 66323162 | 100 T 300-3,8 Q SG RAIL STEEL/22,23 |
|                                |        |        | 25.4   | Q (medium-hard) | 6,400    | A        | 20  | 66323163 | 100 T 300-3,8 Q SG RAIL STEEL/25,4  |
|                                | 350    | 3.8    | 22.23  | Q (medium-hard) | 5,500    | A        | 10  | 66323662 | 100 T 350-3,8 Q SG RAIL STEEL/22,23 |

Continued on next page

# Rail cut-off wheels dia. 300–400 mm

Performance Line SG ★★☆☆



| Maximum operating speed [m/s] | D [mm] | T [mm] | H [mm] | Hardness grade  | Max. RPM | Abrasive |  | Item no.                 | Designation                         |
|-------------------------------|--------|--------|--------|-----------------|----------|----------|---|--------------------------|-------------------------------------|
| 100                           | 350    | 3.8    | 25.4   | Q (medium-hard) | 5,500    | A        | 10  | 66323663                 | 100 T 350-3,8 Q SG RAIL STEEL/25,4  |
|                               |        | 4      | 22.23  | R (hard)        | 5,500    | A        | 10  | <a href="#">66323664</a> | 100 T 350-4,0 R SG RAIL STEEL/22,23 |
|                               |        |        | 25.4   | R (hard)        | 5,500    | A        | 10  | <a href="#">66323665</a> | 100 T 350-4,0 R SG RAIL STEEL/25,4  |
|                               | 400    | 4.2    | 25.4   | Q (medium-hard) | 4,800    | A        | 10  | 66324163                 | 100 T 400-4,2 Q SG RAIL STEEL/25,4  |



# HEAVY DUTY cut-off wheels

## dia. 250–600 mm

Special Line SGP ★★★★★



### SGP HD STEEL ★★★★★

Tool for the most demanding cutting work on steel. Particularly well suited to use in finishing work and to cutting solid material, profiles, pipes and large cross-sections. Suitable tool drives: HEAVY DUTY cutting machine.

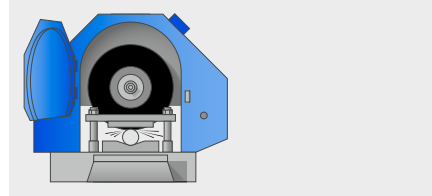

- Fast work progress thanks to excellent cutting characteristics.

#### Special features:

- Ultimate economic efficiency due to optimum tool life.

| Maximum operating speed [m/s]  | D [mm] | T [mm] | H [mm]          | Hardness grade  | Max. RPM | Abrasive |  | Item no.                          | Designation                       |
|--------------------------------|--------|--------|-----------------|-----------------|----------|----------|---|-----------------------------------|-----------------------------------|
| <b>Flat design T (type 41)</b> |        |        |                 |                 |          |          |   |                                   |                                   |
| 80                             | 300    | 3.4    | 25.4            | Q (medium-hard) | 5,100    | A        | 20  | 66323025                          | 80 T 300-3,4 Q SGP HD STEEL/25,4  |
|                                | 350    | 3.8    | 25.4            | Q (medium-hard) | 4,400    | A        | 10  | 66323525                          | 80 T 350-3,8 Q SGP HD STEEL/25,4  |
|                                | 400    | 4.2    | 40              | Q (medium-hard) | 3,800    | A        | 10  | 66324040                          | 80 T 400-4,2 Q SGP HD STEEL/40,0  |
|                                | 500    | 5.5    | 40              | Q (medium-hard) | 3,100    | A        | 5   | 66325040                          | 80 T 500-5,5 Q SGP HD STEEL/40,0  |
| 100                            | 250    | 1.8    | 30              | Q (medium-hard) | 7,600    | A        | 20  | 66322130                          | 100 T 250-1,8 Q SGP HD STEEL/30,0 |
|                                |        | 32     | Q (medium-hard) | 7,600           | A        | 20       | 66322132  | 100 T 250-1,8 Q SGP HD STEEL/32,0 |                                   |
|                                | 300    | 3      | 40              | N (soft)        | 6,400    | A        | 20  | 66323195                          | 100 T 300-3,0 N SGP HD STEEL/40,0 |
|                                |        | 3.6    | 40              | Q (medium-hard) | 6,400    | A        | 20  | 66323140                          | 100 T 300-3,6 Q SGP HD STEEL/40,0 |
|                                | 350    | 3.8    | 40              | N (soft)        | 5,500    | A        | 10  | 66323695                          | 100 T 350-3,8 N SGP HD STEEL/40,0 |
|                                |        | 4      | 25.4            | Q (medium-hard) | 5,500    | A        | 10  | 66323625                          | 100 T 350-4,0 Q SGP HD STEEL/25,4 |
|                                | 400    | 4.3    | 40              | N (soft)        | 4,800    | A        | 10  | 66324195                          | 100 T 400-4,3 N SGP HD STEEL/40,0 |
|                                |        | 4.6    | 40              | S (hard)        | 4,800    | A        | 10  | 66324140                          | 100 T 400-4,6 S SGP HD STEEL/40,0 |
|                                |        | 4.8    | 40              | Q (medium-hard) | 4,800    | A        | 10  | 66324205                          | 100 T 400-4,8 Q SGP HD STEEL/40,0 |
|                                | 500    | 5.8    | 40              | N (soft)        | 3,800    | A        | 5   | 66325205                          | 100 T 500-5,8 N SGP HD STEEL/40,0 |
|                                |        |        |                 | Q (medium-hard) | 3,800    | A        | 5   | 66325140                          | 100 T 500-5,8 Q SGP HD STEEL/40,0 |
|                                |        |        |                 | S (hard)        | 3,800    | A        | 5   | 66325225                          | 100 T 500-5,8 S SGP HD STEEL/40,0 |
| 6.3                            |        | 40     | L (soft)        | 3,800           | A        | 5        | 66325050  | 100 T 500-6,3 L SGP HD STEEL/40,0 |                                   |
| 600                            | 7.6    | 60     | N (soft)        | 3,200           | A        | 5        | 66397706  | 100 T 600-7,6 N SGP HD STEEL/60,0 |                                   |
|                                |        |        | S (hard)        | 3,200           | A        | 5        | 66397707  | 100 T 600-7,6 S SGP HD STEEL/60,0 |                                   |



# HEAVY DUTY cut-off wheels

## dia. 250–600 mm

Special Line SGP ★★★★★



### ZIRKON SGP HD CAST + STEEL ★★★★★

For the most demanding cutting work on cast iron and steel. Suitable for cutting risers, sprues, solid material, profiles, pipes and large cross-sections. Developed for use in foundries. Suitable tool drives: HEAVY DUTY cutting machine.

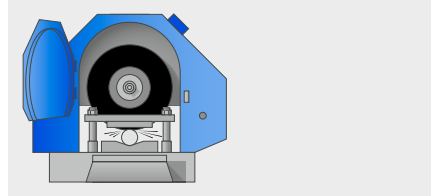

- Fast work progress thanks to excellent cutting characteristics.
- Products made to order available on request.

#### Special features:

- Ultimate economic efficiency due to optimum tool life.

| Maximum operating speed [m/s]  | D [mm] | T [mm] | H [mm] | Hardness grade  | Max. RPM | Abrasive |  | Item no. | Designation                                   |
|--------------------------------|--------|--------|--------|-----------------|----------|----------|---|----------|---|
| <b>Flat design T (type 41)</b> |        |        |        |                 |          |          |   |          |   |
| 100                            | 400    | 4.8    | 40     | T (very hard)   | 4,800    | Z/A      | 10  | 66323235 | 100 T 400-4,8 ZIRKON T SGP HD CAST+STEEL/40,0 |
|                                | 500    | 5.6    | 40     | T (very hard)   | 3,800    | Z/A      | 5   | 66325065 | 100 T 500-5,6 ZIRKON T SGP HD CAST+STEEL/40,0 |
|                                | 600    | 7.8    | 60     | P (medium-hard) | 3,200    | Z/A      | 5   | 66397708 | 100 T 600-7,8 ZIRKON P SGP HD CAST+STEEL/60,0 |
|                                |        | 8      | 60     | R (hard)        | 3,200    | Z/A      | 5   | 66397196 | 100 T 600-8,0 ZIRKON R SGP HD CAST+STEEL/60,0 |



# Reducing rings for stationary cut-off wheels

## Reducing rings for stationary cut-off wheels

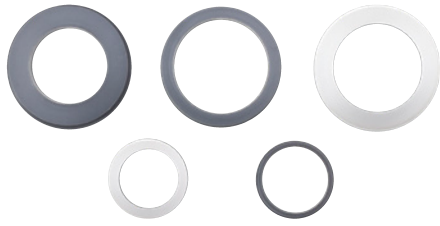

### Reducing rings for stationary cut-off wheels

Reducing rings enable secure adjustment of the standard centre hole to a reduced centre hole dimension.

**Special features:**

- Flexible adjustment to the prerequisites of the drive system.
- With stop collar, to prevent the ring from pushing through the centre hole of the cut-off wheel.

| External diameter [mm] | Inner diameter [mm] | Width [mm] |  | Item no. | Designation       |
|------------------------|---------------------|------------|---|----------|-------------------|
| 25.4                   | 20                  | 3          | 5   | 69900173 | RDR 25,4-20-3,0   |
|                        | 22.23               | 3          | 5   | 69900174 | RDR 25,4-22,2-3,0 |
| 40                     | 25.4                | 3          | 5   | 69900172 | RDR 40-25,4-3,0   |
|                        |                     | 4.5        | 5   | 69900009 | RDR 40-25,4-4,5   |
|                        | 30                  | 3          | 5   | 69900171 | RDR 40-30-3,0     |
|                        |                     | 4.5        | 5   | 69900007 | RDR 40-30-4,5     |
|                        | 32                  | 3          | 5   | 69900170 | RDR 40-32-3,0     |
|                        |                     | 4.5        | 5   | 69900006 | RDR 40-32-4,5     |
| 60                     | 40                  | 6.5        | 5   | 69900175 | RDR 60-40-6,5     |

