



## Industrial power brushes

# Industrial power brushes

## Table of contents



### Industrial power brushes

- Highlights from the PFERD range 4
- Filament materials and their application 5
- Quick product selection guide 6
- Safety notes 9
- Peripheral speeds 10
- Well packaged and presented 11



### Threaded cup brushes

- Crimped 12
- Knotted 13



### Threaded bevel brushes

- Crimped 18
- Knotted 18

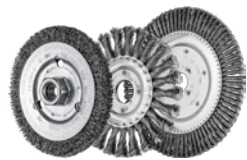

### Wheel brushes

- Crimped 20
- Knotted 20
- Pipeline 25
- Knot wheels 29
- Crimped, single rings 31
- Crimped, unthreaded 32



### Composite brushes

- Wheel brushes, crimped 36
- Composite disc brushes, crimped 38
- Shank-mounted end brushes, crimped 41



### Shank-mounted end brushes

- Crimped 42
- Knotted 46



### Shank-mounted cup brushes

- Crimped 49



### Shank-mounted bevel brushes

- Crimped 50



### Shank-mounted wheel brushes

- Crimped 52
- Knotted 53



### Drum brushes

- Crimped 54

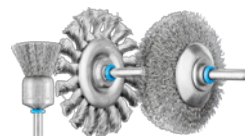

### INOX-TOTAL

- Wheel brushes 55
- Shank-mounted wheel brushes 56
- Shank-mounted bevel brushes 57



### Miniature brushes

- End brushes, crimped 58
- Cup brushes, crimped 59
- Wheel brushes, crimped 60
- Miniature Brush Set – 15 Pieces 61



### Tube brushes

- Tube brushes 62
- Fitting brushes 67





### Universal brushes

■ Threaded cup brushes, crimped	69
■ Threaded cup brushes, knotted	69
■ Wheel brushes, crimped for angle grinders	70
■ Wheel brushes, knotted	70
■ Wheel brushes, pipeline	71
■ Wheel brushes, crimped	71
■ Shank-mounted end brushes, crimped	72
■ Shank-mounted universal end brushes, knotted	73
■ Shank-mounted universal cup brushes, crimped	73
■ Shank-mounted universal wheel brushes, crimped	74
■ Shank-mounted universal wheel brushes, knotted	75
■ Universal scratch brushes, crimped	75

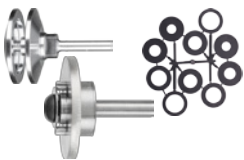

### Accessories

■ Arbor	76
■ Adapters	77
■ Thread adapters	80



### Scratch brushes

■ Scratch brushes	81
■ Platers and molders brushes	85
■ Block brushes	86



### Maintenance brushes

■ Chip brushes	88
■ Floor sweeps	90
■ Upright and whisk brooms	97
■ Squeegees	98
■ Handles and accessories	99
■ Dust pans	102
■ Utility brushes	102
■ Internal cleaning brushes	105
■ Parts cleaning brushes	107
■ Paint brushes	108
■ Miscellaneous painters brushes	110
■ Paint rollers and frames	111
■ Paint trays	113

# Industrial power brushes

## Highlights from the PFERD range



### Composite brushes for stationary applications

PFERD offers a comprehensive range of high-quality industrial power brushes, specially designed for stationary applications on robots and CNC machines.

Composite brushes from PFERD are specifically developed for industrial, automated use. They feature an extremely high filament density and a very even distribution of the filament material when compared to conventional metal-constructed brushes. This guarantees a long service life and extremely smooth running. All of PFERD's industrial power brushes can also be used on robots.

Industrial power brushes in stationary applications are most commonly used for deburring and rounding edges, processing holes and female threads, surface work and cleaning.

Scan the QR code to find out more about composite brushes for stationary applications.

#### Advantages:

- Long tool life and aggressive brushing action due to the high filament density.
- High flexibility due to their ability to adapt to contours. Robots that are used with industrial power brushes are easier to program and can often be used without compliance.
- Very reliable process with extremely smooth operation due to even distribution of the filament material.



### INOX-TOTAL

For extremely difficult operating conditions, PFERD offers a range of "INOX-TOTAL" (IT) brushes. All parts of these brushes are made of grade 302 stainless steel, which ensures optimum corrosion protection.

#### Structure of a wheel brush with arbor hole INOX-TOTAL:

- ① Stainless steel (INOX) side plates
- ② Stainless steel (INOX) center ring
- ③ Stainless steel (INOX) filament

Scan the QR code to find out more about INOX-TOTAL brushes.

#### Advantages:

- Maximum protection against corrosion as all components are produced from stainless steel (INOX) of quality 1.4310 (V2A).

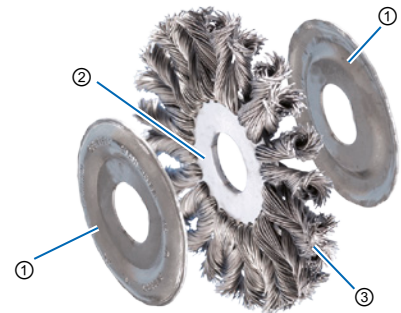

### Find additional in-depth information online

Scan the QR code to find out a wide range of tool and application knowledge relating to PFERD's high-quality tools and their huge variety of materials.

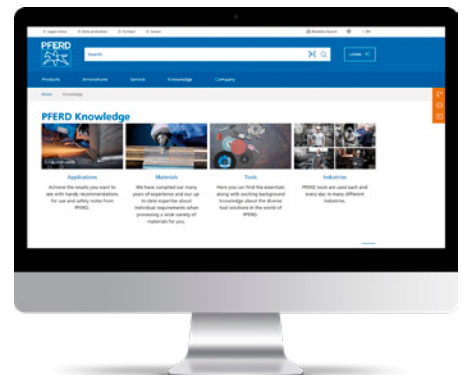

### Selecting the filament material

Filament material	Workpiece materials						
	Steel	Stainless steel (INOX)	Non-ferrous metals			Cast iron	Plastics
			Aluminum	Soft non-ferrous metals Brass, copper, zinc	Hard non-ferrous metals Titanium, bronze, nickel-based and cobalt-based alloys		
Steel wire (ST)	●	-	-	-	-	●	○
Stainless steel wire (INOX)	○	●	●	○	○	-	-
Stainless steel wire (INOX) Diamond (DIA)	○	-	-	-	●	●	●
Brass wire (MES)	-	-	-	●	-	-	-
Silicon carbide (SiC)	●	●	●	-	○	●	●
Aluminium oxide (AO)	○	○	●	-	-	○	○
Ceramic oxide grain (CO)	●	○	○	-	●	●	-
Diamond (DIA)	○	-	-	-	●	●	●
Nylon	-	-	○	○	-	-	●
Natural bristle (with polishing paste)	●	●	●	●	●	●	●

● = highly recommended    ○ = recommended    - = not recommended

#### Wire filament

- Crimped brushes: For work requiring high flexibility, such as brushing of highly contoured workpieces.
- Knot brushes: For work that requires aggressive brushing behavior, such as work on weld seams.

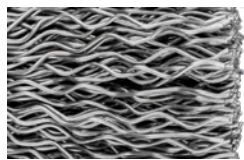

#### Steel wire (ST)

Advantages/properties:

- Proprietary PFERD wire with high tensile strength and bending fatigue strength.
- Ensures long service life, excellent abrasion, and wear-resistance.
- Temperature resistance: up to 600°F

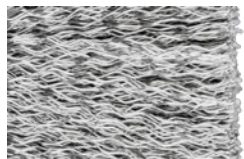

#### Stainless steel wire (INOX)

Advantages/properties:

- Corrosion-resistant; wire quality 1.4310 (V2A).
- Used with low rotational speeds, compared to steel wire.
- Temperature resistance: up to 850°F



#### Stainless steel wire (INOX) diamond (DIA)

Advantages/properties:

- Ideal for aggressive surface conditioning applications.
- Primarily used on materials with high material strength.
- Temperature resistance: up to 850°F

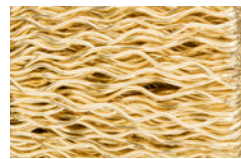

#### Brass wire (MES)

Advantages/properties:

- Brass wire is softer than steel wire; wire quality CuZn37.
- It is non-sparking and produces fine surface finishes.
- Temperature resistance: up to 350°F

#### Plastic filament

- Abrasive grains are embedded in flexible plastic filaments, which means that the filament works on the sides as well as at the tip.
- Round filament: for applications that place particular demands on the flexibility of the brush.
- Rectangular filament: for applications that place particular demands on the aggressiveness of the brush.
- Recommendation for use: Use coolant for applications where large amounts of heat are produced.

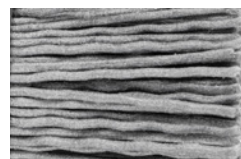

#### Silicon carbide (SiC)

Advantages/properties:

- Ideal for deburring work and for improving surfaces.
- Temperature resistance: up to 410°F

# Industrial power brushes

## Filament materials and their application



### Aluminum oxide (AO)

Advantages/properties:

- Less sharp-edged and aggressive compared with SiC.
- Primarily designed for polishing and smoothing finishes on soft metals.
- Temperature resistance: up to 410°F

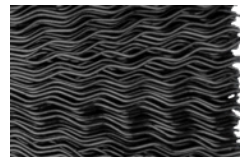

### Nylon

Advantages/properties:

- Ideal for materials that would otherwise be scratched or damaged, e.g. soft plastics.
- Temperature resistance: up to 410°F

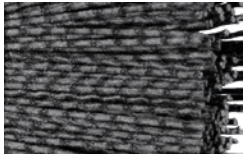

### Ceramic oxide grain (CO)

Advantages/properties:

- Offers good toughness and excellent sharpness.
- For high stock removal and aggressive brushing.
- Temperature resistance: up to 410°F

### Natural bristles

- Excellent for light cleaning and dust removal, as well as for polishing (in combination with polishing pastes).



### Tampico

Advantages/properties:

- Very good durability with excellent liquid retention in maintenance applications.
- Temperature resistance: up to 300°F



### Diamond (DIA)

Advantages/properties:

- Ideal for aggressive surface conditioning applications.
- Primarily used on materials with high material strength.
- Temperature resistance: up to 410°F



### Goat hair

Advantages/properties:











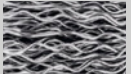
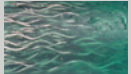





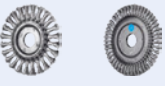





















- Goat hair is more flexible and softer than bristle.
- Temperature resistance: up to 300°F

## Quick product selection guide

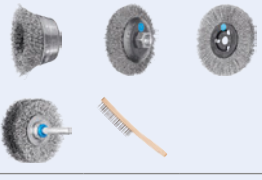
### Quick product selection guide

- ① **Select the filament material.** The material that you are working with is key to determining the optimum filament material.
- ② **Select the filament type.** The brushing effect you want determines which filament type to choose.
- ③ **Select the brush.** The application and geometry of the workpiece indicate the optimum brush.











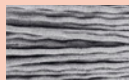



















Workpiece materials	Steel, cast iron, plastics			Stainless steel (INOX), aluminum, other non-ferrous metals	
Filament material	Steel wire (ST) Color code: grey			Stainless steel wire (INOX) Color code: blue	
Filament construction	 knotted	 crimped	 ECAP® encapsulated	 knotted	 crimped
Desired effect	Aggressive brushing effect, less flexible	Light brushing effect, flexible	Very aggressive brushing effect, not flexible	Aggressive brushing effect, less flexible	Light brushing effect, flexible
<b>Weld seam</b> 					
<b>Structuring surfaces</b> 					
<b>Edge deburring</b> 					
<b>Surface deburring</b> 					
<b>Interior deburring</b> 					
<b>Surface cleaning</b> 					
<b>Interior cleaning</b> 					

# Industrial power brushes

## Quick product selection guide



Workpiece materials	Brass, copper, other non-ferrous metals	Steel, stainless steel (INOX), aluminum, non-ferrous metals, titanium, cast, plastics, wood	Steel, stainless steel (INOX), non-ferrous metals, cast iron
Filament material	Brass wire (MES) Color code: yellow	MBRAD® abrasive filament (SiC, CO, nylon) Color code: red	Natural materials Color code: brown
Filament construction	 crimped	 crimped	 crimped
Desired effect	Light brushing effect, flexible	Grinding brushing effect, very flexible	Light brushing effect (use with polishing pastes)
<b>Weld seam</b> 			
<b>Structuring surfaces</b> 			
<b>Edge deburring</b> 	 		
<b>Surface deburring</b> 			
<b>Interior deburring</b> 	   		
<b>Surface cleaning</b> 	 		
<b>Interior cleaning</b> 	 		
<b>Polishing</b> 			



### Safety notes:

As one of the leading manufacturers of brushes, PFERD fulfils the requirements of European standard EN 1083 as well as US ANSI standards. Guidelines on the safe and economic use of PFERD brushes are supplied with every box. This addition helps to increase your level of personal work safety.



Wear eye protection!



Wear hearing protection!



Wear dust respirators!



Wear gloves!



Observe the safety notes!



Use a protective machine guard!



### Maximum permitted rotational speed

In order to guarantee operating safety, the maximum permitted rotational speed indicated on the brush, label and in this catalogue must never be exceeded! Please refer to our product information and product tables for further recommendations regarding optimum operating speeds. These give details of the recommended rotational speeds [RPM] for an optimum working result.

### Brush diameter

In the case of hand-held tool drives, the brush diameter should never exceed 7", regardless of the filament material.

Wheel diameter [Inches]	Minimum arbor hole [Inches]	Minimum face width [Inches]
2	1/4	3/4
3	1/4	3/4
4	3/8	1
6	1/2	1-1/4
8	5/8	1-1/4
10	3/4	2
12	1	3
14	1-1/4	3
15	2	3
16	2	3

### ANSI standard B165.1 arbor holes

ANSI standard B165.1-2013 dictates maximum face widths and minimum arbor hole sizes allowable. All brushes listed in this catalogue conform to all ANSI standards. The maximum face width listed in this table refers to shafts that are supported by one end only, such as angle and bench grinders. It does not apply to shafts that are supported by bearings at both ends.



### Determining the recommended rotational speed

- ① Select the brush type.
- ② Read recommended surface speed.
- ③ Determine the speed using the brush diameter and surface speed. The recommended surface speed ranges [SFPM] depend on the application and are less than the maximum permitted surface speed.

① Brush type	② Surface speed
End brushes	2,500 – 4,000 SFPM
Cup brushes	8,000 – 10,000 SFPM
Shank-mounted wheel brushes	8,000 – 9,500 SFPM
Wheel brushes / bevel cup brushes	See diagram below

### ② Recommended surface speeds for wheel/bevel brushes with arbor hole/ threaded.

The color bars correspond to the filament material color codes.

Application	[SFPM]	1,250	2,000	2,750	3,500	4,250	5,000	5,750	6,500	7,250	8,000	8,750	9,500
Burr removal Edge blending					3,500–7,250 SFPM								
			2,000–5,750 SFPM										
		2,000–5,750 SFPM											
		1,250–5,400 SFPM											
Scale removal						5,000–9,500 SFPM							
					3,500–7,250 SFPM								
Surface conditioning		1,250–4,250 SFPM											
		1,250–3,500 SFPM											
		1,250–3,500 SFPM											
		2,000–5,750 SFPM											
Weld cleaning						5,000–9,500 SFPM							
					3,500–7,250 SFPM								

### ③ Recommended rotational speeds [RPM]

#### Example:

Crimped wire wheelmeter  
Deburring  
Brush diameter D: 6"  
Peripheral speed: 5,400 SFPM  
Rotational speed: 3,450 RPM

n [RPM]	Brush dia. D [Inches]									
	2	3	4	5	6	8	10	12	14	15
800	400	600	800	1,000	1,250	1,650	2,050	2,500	2,900	3,100
1,150	600	900	1,200	1,500	1,800	2,400	3,000	3,600	4,200	4,500
1,200	600	900	1,250	1,550	1,850	2,500	3,100	3,750	4,350	4,700
1,750	900	1,350	1,800	2,250	2,700	3,650	4,550	5,450	6,400	6,850
2,000	1,000	1,550	2,050	2,600	3,100	4,150	5,200	6,250	7,300	7,850
2,400	1,250	1,850	2,500	3,100	3,750	5,000	6,250	7,500	8,750	9,400
3,000	1,550	2,350	3,100	3,900	4,700	6,250	7,850	9,400	10,950	11,750
3,450	1,800	2,700	3,600	4,500	5,400	7,200	9,000	10,800	12,600	13,500
3,750	1,950	2,900	3,900	4,900	5,850	7,850	9,800	11,750		
4,000	2,050	3,100	4,150	5,200	6,250	8,350	10,450	12,550		
4,500	2,350	3,500	4,700	5,850	7,050	9,400	11,750	14,100		
5,000	2,600	3,900	5,200	6,500	7,850	10,450	13,050			
5,400	2,800	4,200	5,650	7,050	8,450	11,300				
6,000	3,100	4,700	6,250	7,850	9,400					
8,500	4,400	6,650	8,850	11,100						
9,000	4,700	7,050	9,400	11,750						
10,000	5,200	7,850	10,450	13,050						
12,000	6,250	9,400	12,550	15,700						
15,000	7,850	11,750	15,700	19,600						
18,000	9,400	14,100	18,800							
20,000	10,450	15,700	16,400							

$$\text{SFPM (v)} = \frac{\text{dia. (D)} \times \pi \times \text{RPM (n)}}{12}$$



## Industrial packaging

PFERD provides industrial power brushes in industrial packaging (IP) as standard.

### Advantages:

- Robust, damage-resistant packaging.

## POS packaging

PFERD provides wheel, cup, end and bevel brushes in promotional individual packaging. Individually packed shank brushes come in practical packages. The addition of "POS" in the designation indicates all brushes in POS packaging.

### Advantages:

- Product can easily be hung up on a sales wall.
- Packaging design allows product to be easily recognized.



IP



POS

## Dimensions

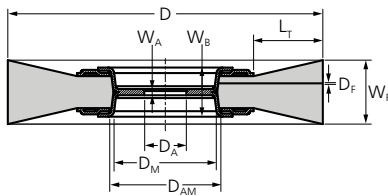

Wheel brushes

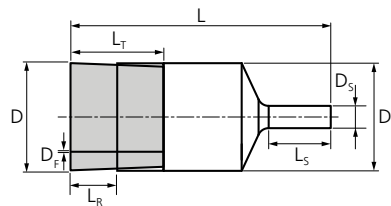

End brushes

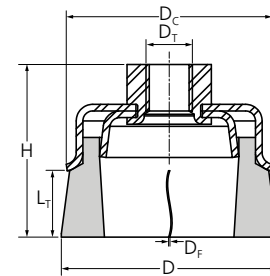

Cup brushes

## Explanation of dimensions

<b>D</b>	Nominal outer diameter/width of the brush; the working surface for end brushes	<b>D<sub>S</sub></b>	Shank diameter in shank-mounted brushes; shaft diameter for drum brushes; stem diameter (core) for pipe brushes	<b>L<sub>S</sub></b>	Usable length for shank or stem, total length of the mounting shaft, usable thread length
<b>D<sub>A</sub></b>	Hole diameter	<b>D<sub>T</sub></b>	Thread size	<b>L<sub>T</sub></b>	Trim length of the filament material, including bridled filament
<b>D<sub>AM</sub></b>	Max. brush arbor hole diameter without adapters	<b>H</b>	Nominal total height (incl. components for arbor hole or thread as well as shank)	<b>W<sub>A</sub></b>	Width of the main body at the arbor hole / thread
<b>D<sub>C</sub></b>	Cup diameter, for stem-mounted and end brushes	<b>L</b>	Nominal total length for tube brushes; block length for maintenance brushes	<b>W<sub>B</sub></b>	Installation width, widest point of the main body
<b>D<sub>F</sub></b>	Nominal diameter/thickness of the filament material	<b>L<sub>R</sub></b>	Total exposed length of the filament material (free length without bridle)	<b>W<sub>F</sub></b>	Face width, nominal dimensions of the working contact width
<b>D<sub>M</sub></b>	Diameter in hole area				

# Threaded cup brushes

## Dimensions



### Custom-made products

If you cannot find the solution for your particular application in our extensive catalog range, we can produce brushes in premium PFERD quality specifically for your application on request. Products that can be made to order include different wire thicknesses and qualities, arbor holes or threads, and additional dimensions.

### Crimped

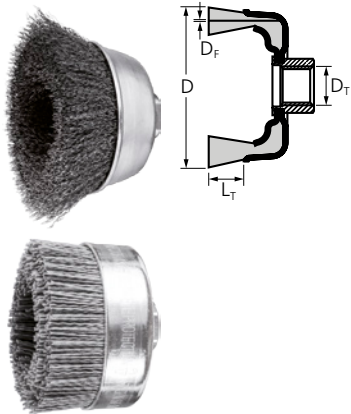

### Crimped shank mounted

Excellent for medium-duty brushing such as deburring, cleaning, and derusting of large surfaces.



#### Special features:

- Highly flexible, enabling optimal adaptation to the workpiece contour.
- Creates fine surfaces.

D [Inch]	L <sub>r</sub> [Inch]	D <sub>r</sub>	Grit size	D <sub>f</sub> [Inch]	Opt. RPM	Max. RPM		Item no.	EDP no.
<b>Steel wire (ST)</b>									
2-3/4	7/8	5/8-11	-	.014	7,000 – 14,000	14,000	5	79184912	82243P
			-	.014	7,000 – 14,000	14,000	5	79182243	82243
		M10x1.25	-	.014	7,000 – 14,000	14,000	5	79184914	82247P
		M10x1.50	-	.014	7,000 – 14,000	14,000	5	79184915	82246P
3	7/8	X-LOCK	-	.012	6,300 – 9,400	12,500	1	43469006	80715
3-1/2	7/8	5/8-11	-	.014	6,000 – 12,500	12,500	1	79182249	82249
			-	.020	6,000 – 12,500	12,500	1	79182255	82255
4	1-1/4	5/8-11	-	.014	4,500 – 9,000	9,000	2	79184742	82510P
			-	.020	4,500 – 9,000	9,000	2	79152511	82511P
			-	.014	4,500 – 9,000	9,000	1	79182510	82510
			-	.020	4,500 – 9,000	9,000	1	79182511	82511
5	1-1/4	5/8-11	-	.020	4,000 – 8,000	8,000	2	79152515	82515P
			-	.014	4,000 – 8,000	8,000	1	79182514	82514
			-	.020	4,000 – 8,000	8,000	1	79182515	82515
6	1-3/8	5/8-11	-	.014	3,000 – 6,000	6,000	2	79184759	82516P
			-				1	79182516	82516
			-	.020	3,000 – 6,000	6,000	2	79152517	82517P
			-				1	79182517	82517
<b>Stainless steel wire (INOX)</b>									
2-3/4	7/8	5/8-11	-	.014	5,500 – 14,000	14,000	5	79184930	82353P
			-					79182353	82353
3-1/2	7/8	5/8-11	-	.014	5,000 – 12,500	12,500	1	79182359	82359
			-	.020	5,000 – 12,500	12,500	1	79182365	82365
4	1-1/4	5/8-11	-	.020	3,500 – 9,000	9,000	1	79182635	82635
6	1-3/8	5/8-11	-	.020	2,000 – 6,000	6,000	1	79182638	82638

Continued on next page

D [Inch]	L <sub>T</sub> [Inch]	D <sub>T</sub>	Grit size	D <sub>F</sub> [Inch]	Opt. RPM	Max. RPM		Item no.	EDP no.
<b>Stainless steel wire (INOX)</b> – These INOX brushes are degreased.									
3	7/8	X-LOCK	-	.012	5,000 – 8,100	12,500	1	43469007	80427
<b>M-BRAD® nylon abrasive filament, silicon carbide SiC</b>									
3-1/2	7/8	5/8-11	120	.040	3,000 – 5,000	12,000	1	79183810	83810
4	1	5/8-11	80	.040	1,500 – 2,500	6,000	1	79183813	83813
			120	.040	1,500 – 2,500	6,000	1	79183814	83814

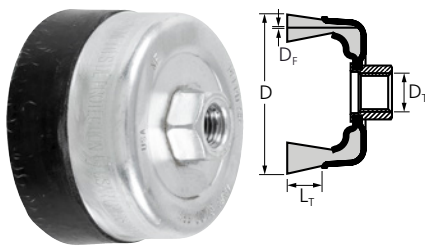

### External nut, ECAP® encapsulated

Extremely aggressive brushing action, ideal for heavy-duty brushing.

#### Special features:

- Maximum service life as premature wire breakage is prevented.
- Precise handling due to high dimensional stability.

D [Inch]	L <sub>T</sub> [Inch]	ECAP® grade	D <sub>T</sub>	D <sub>F</sub> [Inch]	Opt. RPM	Max. RPM		Item no.	EDP no.
<b>Steel wire (ST)</b>									
4	1-1/8	E4	5/8-11	.020	3,500 – 7,000	7,000	1	79183570	83570
6	1-1/4	E4	5/8-11	.020	3,000 – 6,000	6,000	1	79183571	83571

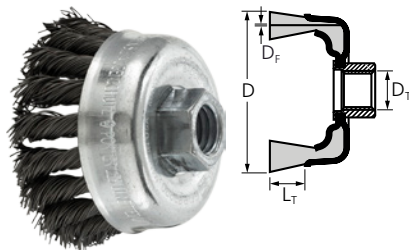

### External nut, single row, standard twist

The knots of the brush are twisted to 75% of the length. The brush is designed for brushing large areas and for heavy-duty brushwork, such as deburring, cleaning, derusting and descaling, as well as removing spatter.

#### Special features:

- Optimal ratio of aggressiveness and flexibility.

D [Inch]	L <sub>T</sub> [Inch]	D <sub>T</sub>	D <sub>F</sub> [Inch]	Knots	Opt. RPM	Max. RPM		Item no.	EDP no.
<b>Steel wire (ST)</b>									
2-3/4	7/8	5/8-11	.014	18	7,000 – 14,000	14,000	5	79152219	82219P
			.020	18	7,000 – 14,000	14,000	5	79182219	82219
		3/8-24	.014	18	7,000 – 14,000	14,000	5	79182223	82223
			.020	18	7,000 – 14,000	14,000	5	79182224	82224
		M10x1.50	.020	18	7,000 – 14,000	14,000	5	79184909	82226P
		M10x1.25	.020	18	7,000 – 14,000	14,000	5	79184908	82228P
3-1/2	7/8	5/8-11	.014	20	6,000 – 12,500	12,500	1	79152231	82231P
			.020	20	6,000 – 12,500	12,500	5	79182231	82231
		.020	20	6,000 – 12,500	12,500	5	79184936	82232P	

Continued on next page

# Threaded cup brushes

## Knotted



D [Inch]	L <sub>T</sub> [Inch]	D <sub>T</sub>	D <sub>F</sub> [Inch]	Knots	Opt. RPM	Max. RPM		Item no.	EDP no.
3-1/2	7/8	5/8-11	.020	20	6,000 – 12,500	12,500	1	79182232	82232
		3/8-24	.020	20	6,000 – 12,500	12,500	1	79182236	82236
4	1-1/4	5/8-11	.014	24	4,500 – 9,000	9,000	2	79152522	82522P
				1	79182522	82522			
			.023	24	4,500 – 9,000	9,000	2	79184739	82523P
				1	79182523	82523			
.035	24	4,500 – 9,000	9,000	1	79182524	82524			
	1	79182529	82529						
5	1-3/8	5/8-11	.023	30	3,500 – 7,000	7,000	1	79182529	82529
6	1-1/2	5/8-11	.014	36	3,000 – 6,000	6,000	1	79182530	82530
				1	79182531	82531			
				36	3,000 – 6,000	6,000	1	79182532	82532

### Stainless steel wire (INOX)

2-3/4	7/8	5/8-11	.014	18	5,500 – 14,000	14,000	5	79152329	82329P
				5	79182329	82329			
		3/8-24	.020	18	5,500 – 14,000	14,000	5	79184924	82330P
								79182330	82330
3-1/2	7/8	5/8-11	.020	20	5,000 – 12,500	12,500	5	79182334	82334
4	1-1/4	5/8-11	.014	24	3,500 – 9,000	9,000	1	79184948	82342P
				1	79182342	82342			
6	1-1/2	5/8-11	.023	36	2,000 – 6,000	6,000	1	79182647	82647
				1	79182648	82648			
6	1-1/2	5/8-11	.014	36	2,000 – 6,000	6,000	1	79182653	82653
				1	79182654	82654			

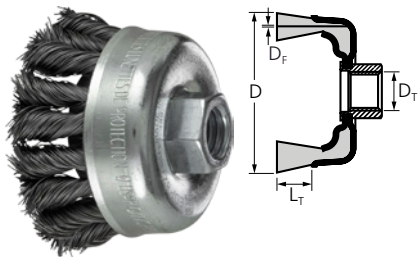

### External nut, standard twist COMBITWIST®

The knots of the brush are twisted to 75% of the length. The brush is designed for brushing large areas and for heavy-duty brushwork, such as deburring, cleaning, derusting and descaling, as well as removing spatter.

#### Special features:

- Maximum economic efficiency due to maximum tool life and stock removal rate. High level of comfort thanks to smooth running with no brush recoiling.
- Designed for work on corners and edges as the knots are less likely to unravel.
- Optimal ratio of aggressiveness and flexibility.



D [Inch]	L <sub>T</sub> [Inch]	D <sub>T</sub>	D <sub>F</sub> [Inch]	Knots	Opt. RPM	Max. RPM		Item no.	EDP no.
<b>Steel wire (ST)</b>									
2-3/4	7/8	5/8-11	.014	18	7,000 – 14,000	14,000	5	79152750	82750P
				5	79182750	82750			
		3/8-24	.020	18	7,000 – 14,000	14,000	5	79152751	82751P
								79182751	82751
3-1/2	7/8	5/8-11	.014	20	6,000 – 12,500	12,500	1	79182401	82401
				1	79182402	82402			
4	1-1/4	5/8-11	.014	24	4,500 – 9,000	9,000	1	79182716	82716
				1	79182717	82717			

Continued on next page

D [Inch]	L <sub>T</sub> [Inch]	D <sub>T</sub>	D <sub>F</sub> [Inch]	Knots	Opt. RPM	Max. RPM		Item no.	EDP no.
5	1-3/8	5/8-11	.023	30	3,500 – 7,000	7,000	1	79182723	82723
6	1-1/2	5/8-11	.023	36	3,000 – 6,000	6,000	1	79182725	82725
<b>Stainless steel wire (INOX)</b>									
2-3/4	7/8	5/8-11	.014	18	5,500 – 14,000	14,000	5	79182855	82855
			.020	18	5,500 – 14,000	14,000	5	79182856	82856
3-1/2	7/8	5/8-11	.020	20	4,000 – 9,000	12,500	1	79182431	82431
4	1-1/4	5/8-11	.014	24	3,500 – 9,000	9,000	1	79182789	82789
			.023	24	3,500 – 9,000	9,000	1	79182790	82790
<b>Brass wire</b>									
3-1/2	7/8	5/8-11	.020	20	5,000 – 12,500	12,500	1	79182368	82368

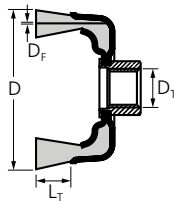

### Single row, full cable twist

Aggressive brush. Excellent for heavy-duty brushing applications like deburring, cleaning, derusting, descaling, and removal of spatter.



#### Special features:

- Aggressive brushing effect due to the very stiff knotted wire.

D [Inch]	L <sub>T</sub> [Inch]	D <sub>T</sub>	D <sub>F</sub> [Inch]	Knots	Opt. RPM	Max. RPM		Item no.	EDP no.
<b>Steel wire (ST)</b>									
2-3/4	3/4	X-LOCK	.014	18	6,300 – 12,500	12,500	1	43305025	80716
			.020	18	6,300 – 12,500	12,500	1	43305026	80717
3	3/4	X-LOCK	.020	20	5,000 – 10,000	11,500	1	43306036	80718
<b>Stainless steel wire (INOX) – These INOX brushes are degreased.</b>									
2-3/4	3/4	X-LOCK	.014	18	5,000 – 12,500	12,500	1	43305027	80428
			.020	18	5,000 – 12,500	12,500	1	43305028	80429

# Threaded cup brushes

## Knotted

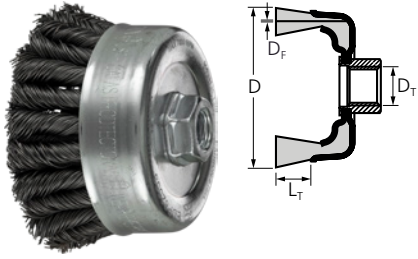

### External nut, standard twist COMBITWIST®

The knots of the brush are twisted to 75% of the length. The brush is designed for brushing large areas and for heavy-duty brushwork, such as deburring, cleaning, derusting and descaling, as well as removing spatter.

#### Special features:

- Maximum economic efficiency due to maximum tool life and stock removal rate. High level of comfort thanks to smooth running with no brush recoiling.
- Designed for work on corners and edges as the knots are less likely to unravel.
- Double-row design enables fast results due to larger filament width.

D [Inch]	L <sub>r</sub> [Inch]	D <sub>t</sub>	D <sub>f</sub> [Inch]	Knots	Opt. RPM	Max. RPM		Item no.	EDP no.
<b>Steel wire (ST)</b>									
4	1-3/8	5/8-11	.020	48	3,500 – 7,000	7,000	1	79182553	82553
6	1-1/2	5/8-11	.020	66	3,000 – 6,000	6,000	1	79182557	82557
			.023	66	3,000 – 6,000	6,000	1	79182558	82558
<b>Stainless steel wire (INOX)</b>									
4	1-3/8	5/8-11	.020	48	2,500 – 7,000	7,000	1	79182657	82657

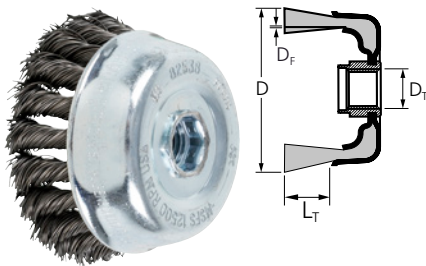

### Internal nut, single row, standard twist

The knots of the brush are twisted to 75% of the length. The brush is designed for brushing large areas and for heavy-duty brushwork, such as deburring, cleaning, derusting and descaling, as well as removing spatter.

#### Special features:

- Aggressive brushing action due to tightly-twisted wire knots.
- With female thread for optimum guidability and fatigue-free working.

D [Inch]	L <sub>r</sub> [Inch]	D <sub>t</sub>	D <sub>f</sub> [Inch]	Knots	Opt. RPM	Max. RPM		Item no.	EDP no.
<b>Steel wire (ST)</b>									
3-1/2	7/8	5/8-11	.020	20	6,000 – 12,500	12,500	1	79182538	82538
4	1-1/2	5/8-11	.014	24	3,500 – 7,000	7,000	1	79182539	82539
			.023	24	3,500 – 7,000	7,000	1	79182540	82540
6	1-5/8	5/8-11	.014	36	3,000 – 6,000	6,000	2	79152545	82545P
							1	79182545	82545
			.023	36	3,000 – 6,000	6,000	2	79184755	82546P
							1	79182546	82546





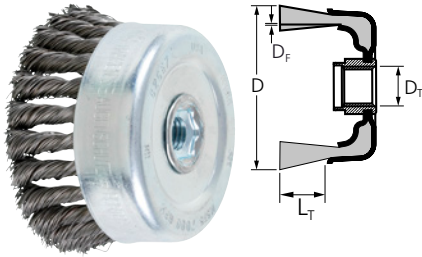

### Internal nut, single row, full cable twist

Aggressive brush with internal thread. Excellent for heavy-duty brushing such as deburring, cleaning, derusting and descaling and removal of spatter.

**Special features:**

- Aggressive brushing action due to tightly-twisted wire knots.
- With female thread for optimum guidability and fatigue-free working.

D [Inch]	L <sub>T</sub> [Inch]	D <sub>T</sub>	D <sub>F</sub> [Inch]	Knots	Opt. RPM	Max. RPM		Item no.	EDP no.
<b>Steel wire (ST)</b>									
4	1-3/8	5/8-11	.020	24	3,500 – 7,000	7,000	1	79182567	82567
6	1-1/2	5/8-11	.023	36	3,000 – 6,000	6,000	1	79182571	82571

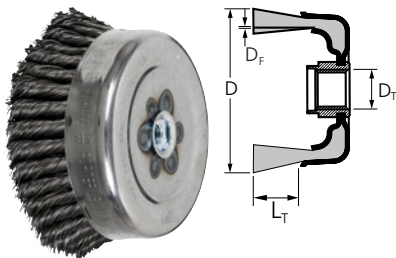

### Internal nut, double row, full cable twist

Aggressive brush with internal thread. Excellent for heavy-duty brushing such as deburring, cleaning, derusting and descaling and removal of spatter.

**Special features:**

- Aggressive brushing action due to tightly-twisted wire knots.
- Double-row design enables fast results due to larger filament width.
- With female thread for optimum guidability and fatigue-free working.

D [Inch]	L <sub>T</sub> [Inch]	D <sub>T</sub>	D <sub>F</sub> [Inch]	Knots	Opt. RPM	Max. RPM		Item no.	EDP no.
<b>Steel wire (ST)</b>									
6	1-1/2	5/8-11	.023	66	3,000 – 6,000	6,000	1	79182574	82574

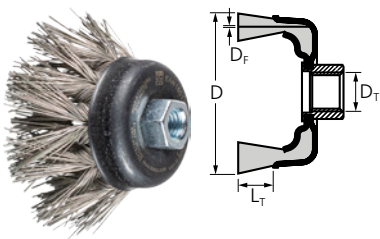

### Diamond coated, standard twist

INOX DIA filament brushes are designed for particularly demanding applications that require an aggressive brush. They are primarily used on extremely hard materials.

**Special features:**

- The knots of the brush are twisted to 50% of the length, ensuring an optimal ratio of aggressiveness and flexibility.
- The brush achieves a better surface quality on uneven surfaces when compared to knotted brushes.

D [Inch]	L <sub>T</sub> [Inch]	D <sub>T</sub>	Grit size	D <sub>F</sub> [Inch]	Knots	Opt. RPM	Max. RPM		Item no.	EDP no.
<b>Stainless steel wire (INOX) diamond (DIA)</b>										
2-3/4	1-5/8	5/8-11	270	.020	18	1,000 – 2,800	11,000	1	79184352	84352
			400	.020	18	1,000 – 2,800	11,000	1	79184353	84353
4	1-1/2	5/8-11	270 (coarse)	.020	24	1,000 – 2,400	9,000	1	79184348	84348
			400	.020	24	1,000 – 2,400	9,000	1	79184349	84349

# Threaded bevel brushes

Crimped

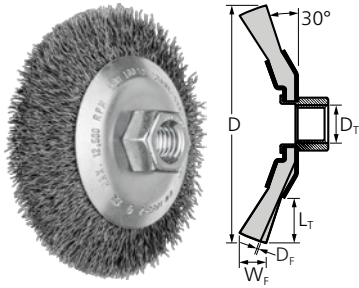

## Crimped

Excellent for medium-duty brushing such as deburring, cleaning and derusting. Can be used on angle grinders up to 80 m/s.



### Special features:

- Ideal for cleaning narrow or hard-to-reach areas such as grooves, fillets, and inside edges.
- Highly flexible, enabling optimal adaptation to the workpiece contour.
- Creates fine surfaces.

D [Inch]	W <sub>F</sub> [Inch]	L <sub>T</sub> [Inch]	D <sub>T</sub>	D <sub>F</sub> [Inch]	Opt. RPM	Max. RPM		Item no.	EDP no.
<b>Steel wire (ST)</b>									
4	1/2	3/4	5/8-11	.014	6,000 – 12,500	12,500	5	79182213	82213
4-1/2	1/2	1-1/8	5/8-11	.014	6,000 – 12,500	12,500	5	79182256	82256
5	3/8	7/8	5/8-11	.014	6,000 – 11,000	11,000	5	79182257	82257
<b>Stainless steel wire (INOX)</b>									
4	1/2	3/4	5/8-11	.014	5,000 – 12,500	12,500	5	79182370	82370
4-1/2	1/2	1-1/8	5/8-11	.014	5,000 – 12,500	12,500	5	79182371	82371
5	3/8	7/8	5/8-11	.014	5,000 – 11,000	11,000	5	79182372	82372



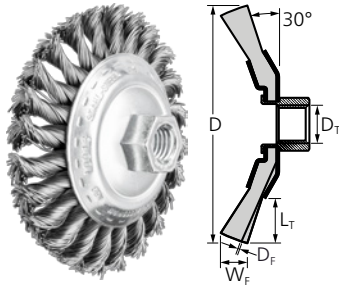

### Knot wire, full cable twist

Aggressive brush. Excellent for heavy-duty brushing such as deburring, cleaning, derusting and descaling and removal of spatter.



#### Special features:

- Ideal for cleaning narrow or hard-to-reach areas such as grooves, fillets, and inside edges.
- Aggressive brushing action due to tightly-twisted wire knots.

D [Inch]	W <sub>F</sub> [Inch]	L <sub>T</sub> [Inch]	D <sub>T</sub>	D <sub>F</sub> [Inch]	Knots	Opt. RPM	Max. RPM		Item no.	EDP no.
<b>Steel wire (ST)</b>										
4	1/2	3/4	5/8-11	.020	22	10,000 – 15,000	20,000	5	79184966	82202P
				.014	22	10,000 – 15,000	20,000	5	79182202	82202
4-1/2	1/2	1	5/8-11	.014	24	7,500 – 15,000	15,000	1	79182201	82201
				.020	24	7,500 – 15,000	15,000	1	79182500	82500
5	1/2	3/4	5/8-11	.020	28	7,500 – 15,000	15,000	1	79182501	82501
7	1/2	1-1/8	5/8-11	.020	28	7,500 – 15,000	15,000	1	79182505	82505
<b>Stainless steel wire (INOX)</b>										
4	1/2	3/4	5/8-11	.014	22	8,000 – 15,000	20,000	5	79182509	82509
4-1/2	1/2	1	5/8-11	.014	24	8,000 – 15,000	20,000	5	79182317	82317
5	1/2	3/4	5/8-11	.014	24	6,000 – 15,000	15,000	1	79182625	82625
5	1/2	3/4	5/8-11	.014	28	6,000 – 15,000	15,000	1	79182629	82629

# Wheel brushes

## Crimped

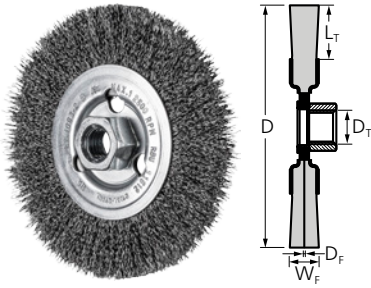

### Crimped wheel for angle grinders

Ideal for brushing uneven surfaces. Used for light to medium duty brushing action such as removal of light scale, dirt, rust, corrosion, and light burrs. These brushes can be used on angle grinders.



#### Special features:

- Highly flexible, enabling optimal adaptation to the workpiece contour.
- Creates fine surfaces.

D [mm]	W <sub>F</sub> [Inch]	L <sub>T</sub> [Inch]	D <sub>T</sub>	D <sub>F</sub> [Inch]	Opt. RPM	Max. RPM		Item no.	EDP no.
<b>Steel wire (ST)</b>									
4	1/2	11/16	5/8-11	.014	6,000 – 12,500	12,500	5	79184869	82195P
								79182195	82195
4-1/2	1/2	15/16	5/8-11	.014	6,000 – 12,500	12,500	5	79180024	80024
5	1/2	1-1/8	5/8-11	.014	6,000 – 12,500	12,500	5	79180036	80036
<b>Stainless steel wire (INOX)</b>									
4	1/2	11/16	5/8-11	.014	6,000 – 12,500	12,500	5	79182316	82316
4-1/2	1/2	15/16	5/8-11	.014	6,000 – 12,500	12,500	5	79180354	80354
5	1/2	1-1/8	5/8-11	.014	6,000 – 12,500	12,500	5	79180366	80366
<b>Brass wire</b>									
4	1/2	11/16	5/8-11	.014	6,000 – 12,500	12,500	5	79182367	82367

## Knotted

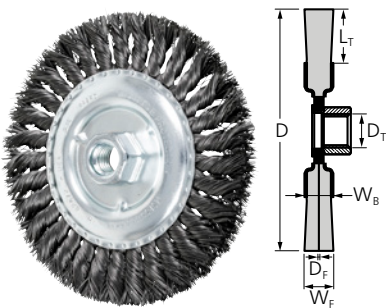

### Standard twist, single row, long flag

The knots of the brush are twisted to 75% of the length. The brush is designed for brushing large areas and for heavy-duty brushwork, such as deburring, cleaning, derusting and descaling, as well as removing spatter.

#### Special features:

- Optimal ratio of aggressiveness and flexibility.

D [Inch]	W <sub>F</sub> [Inch]	L <sub>T</sub> [Inch]	D <sub>A</sub> / D <sub>T</sub>	D <sub>F</sub> [Inch]	Knots	Opt. RPM	Max. RPM		Item no.	EDP no.	
<b>Steel wire (ST)</b>											
3	1/2	5/8	3/8	.012	18	12,500 – 18,700	25,000	10	79181650	81650	
				.014	18	12,500 – 18,700	25,000	10	79181651	81651	
				.020	18	12,500 – 18,700	25,000	10	79181652	81652	
4	5/8	3/4	3/8	.012	22	10,000 – 15,000	20,000	10	79181656	81656	
				.014	22	10,000 – 15,000	20,000	10	79181660	81660	
			7/8	5/8-11	.014	22	10,000 – 15,000	20,000	5	79184865	82153P
								10	79182153	82153	

Continued on next page

D [Inch]	W <sub>F</sub> [Inch]	L <sub>T</sub> [Inch]	D <sub>A</sub> / D <sub>T</sub>	D <sub>F</sub> [Inch]	Knots	Opt. RPM	Max. RPM		Item no.	EDP no.
4	5/8	3/4	3/8	.014	22	10,000 – 15,000	20,000	5	79184866	81657P
								10	79181657	81657
				.020	22	10,000 – 15,000	20,000	10	79181658	81658
		7/8	5/8-11	.020	22	10,000 – 15,000	20,000	10	79182154	82154
5	5/8	5/8	5/8-11	.020	24	7,500 – 15,000	15,000	10	79182470	82470
6	5/8	1-1/8	1/2	.012	32	4,500 – 6,500	9,000	10	79181665	81665
				.014	32	4,500 – 6,500	9,000	5	79184893	81666P
						10	79181666	81666		
		5/8-11	.014	32	4,500 – 9,000	9,000	10	79182471	82471	
		1/2	.016	32	4,500 – 6,500	9,000	5	79151667	81667P	
						10	79181667	81667		
		5/8-11	.016	32	4,500 – 9,000	9,000	10	79182472	82472	
		1/2	.023	32	4,500 – 6,500	9,000	10	79181668	81668	
				10	79182473	82473				
7	5/8	1-5/8	5/8	.014	32	4,500 – 6,500	9,000	2	79181694	81694
8	5/8	1-5/8	5/8	.016	42	3,500 – 5,000	7,000	5	79184895	81704P
15	7/8	3-1/2	1-1/4	.016	60	1,500 – 2,500	3,600	2	79181773	81773
<b>Stainless steel wire (INOX)</b>										
3	7/16	3/4	3/8	.012	18	10,000 – 16,000	25,000	10	79181800	81800
				.014	18	10,000 – 16,000	25,000	10	79181801	81801
4	5/8	3/4	3/8	.012	22	8,000 – 13,000	20,000	10	79181806	81806
				.014	22	8,000 – 13,000	20,000	5	79151807	81807P
						10	79181807	81807		
		7/8	5/8-11	.014	22	8,000 – 15,000	20,000	5	79184867	82283P
						10	79182283	82283		
		3/4	3/8	.020	22	8,000 – 13,000	20,000	10	79181808	81808
				10	79182284	82284				
				10	79182284	82284				
5	5/8	5/8	5/8-11	.020	24	6,000 – 15,000	15,000	10	79182596	82596
6	5/8	1-1/8	1/2	.016	32	3,500 – 5,500	9,000	10	79181816	81816
				.016	32	3,500 – 9,000	9,000	10	79182597	82597
				.023	32	3,500 – 9,000	9,000	10	79182598	82598
<b>Brass wire</b>										
4	5/8	7/8	5/8-11	.014	22	8,000 – 15,000	20,000	10	79182366	82366

# Wheel brushes

## Knotted

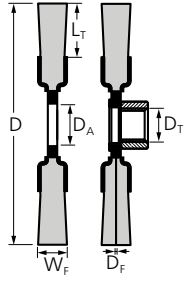

### Knot wire, full cable twist

Aggressive brush. Designed for heavy-duty brushing in metalwork such as descaling, derusting, deburring, cleaning of weld seams, removal of adhesive residues and spatter.



#### Special features:

- Aggressive brushing action due to tightly-twisted wire knots.

D [Inch]	W <sub>F</sub> [Inch]	L <sub>T</sub> [Inch]	D <sub>A</sub> / D <sub>T</sub>	D <sub>F</sub> [Inch]	Knots	Opt. RPM	Max. RPM		Item no.	EDP no.					
<b>Steel wire (ST)</b>															
4	5/8	7/8	X-LOCK	.014	22	10,000 – 15,000	20,000	1	79180705	80705					
									3/8	3/4	3/8	.020	22	10,000 – 15,000	20,000
			1/2	3/4	5/8-11	.014	22	10,000 – 15,000	20,000	5	79152165	82165P			
											.020	22	10,000 – 15,000	20,000	10
						5	79184844	82166P							
						10	79182166	82166							
						10	79182170	82170							
						X-LOCK	.014	22	10,000 – 15,000	20,000	1	79180706	80706		
.020	22	10,000 – 15,000	20,000	1	79180707							80707			
1/2-13	.020	22	10,000 – 15,000	20,000	10	79182168	82168								
						10	79182170	82170							
4-1/2	1/2	7/8	X-LOCK	.020	24	6,300 – 12,500	12,500	1	43312031	80708					
									13/16	7/8	.020	24	6,000 – 9,000	12,500	10
5	1/2	3/4	5/8-11	.023	24	7,500 – 15,000	15,000	5	79184884	82474P					
									10	79182474	82474				
4-7/8	1/2	1-1/16	X-LOCK	.020	24	6,300 – 12,500	12,500	1	43303035	80709					
6	1/2	1-1/4	1/2	.023	30	5,000 – 7,500	10,000	10	79182113	82113					
									5/8-11	.016	30	5,000 – 10,000	10,000	5	79152476
			.023	24	5,000 – 10,000	10,000	5	79152477							82477P
								10							79182477
			5	5,000 – 10,000	10,000	5	79184885	82478P							
10	79182478	82478													
<b>Stainless steel wire (INOX)</b>															
4	1/2	3/4	5/8-11	.014	22	8,000 – 15,000	20,000	5	79152295	82295P					
									10	79182295	82295				
										10	79182296	82296			
5	1/2	3/4	5/8-11	.023	24	6,000 – 15,000	15,000	10	79182599	82599					
6	1/2	1-1/4	5/8-11	.023	24	4,000 – 10,000	10,000	10	79182602	82602					
									30	4,000 – 10,000	10,000	10	79182603	82603	
<b>Stainless steel wire (INOX) – These INOX brushes are degreased.</b>															
4	5/8	7/8	X-LOCK	.014	22	8,000 – 15,000	20,000	1	79180422	80422					
4-1/2	1/2	7/8	X-LOCK	.020	24	5,000 – 12,500	12,500	1	43312036	80423					
4-7/8	1/2	1-1/16	X-LOCK	.020	24	5,000 – 12,500	12,500	1	43303038	80424					



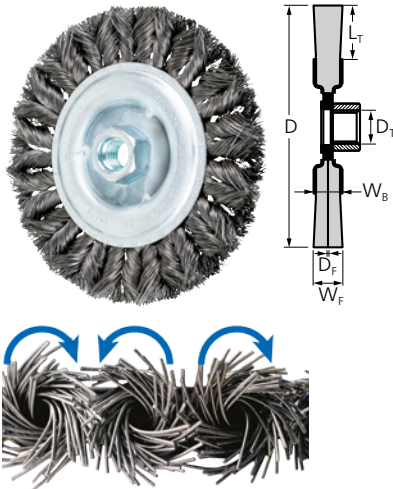

### Standard twist, COMBITWIST®

The knots of the brush are twisted to 75% of the length. The brush is designed for brushing large areas and for heavy-duty brushwork, such as deburring, cleaning, derusting and descaling, as well as removing spatter.

#### Special features:

- Maximum economic efficiency due to maximum tool life and stock removal rate and high level of comfort thanks to smooth running with no brush recoiling.
- Designed for work on corners and edges as the knots are less likely to unravel.
- Aggressive brushing effect due to the very stiff knotted wire.

D [Inch]	W <sub>F</sub> [Inch]	L <sub>T</sub> [Inch]	D <sub>A</sub> / D <sub>T</sub>	D <sub>F</sub> [Inch]	Knots	Opt. RPM	Max. RPM		Item no.	EDP no.
<b>Steel wire (ST)</b>										
4	5/8	7/8	5/8-11	.014	22	10,000 – 15,000	20,000	10	79182383	82383
				.020	22	10,000 – 15,000	20,000	10	79182384	82384
5	5/8	5/8	5/8-11	.020	24	7,500 – 15,000	15,000	10	79182680	82680
6	5/8	1-1/8	5/8-11	.014	32	4,500 – 9,000	9,000	10	79182681	82681
				.016	32	4,500 – 9,000	9,000	10	79182682	82682
				.023	32	4,500 – 9,000	9,000	10	79182683	82683
<b>Stainless steel wire (INOX)</b>										
4	5/8	7/8	5/8-11	.014	22	8,000 – 15,000	20,000	10	79182412	82412
				.020	22	8,000 – 15,000	20,000	10	79182413	82413
5	5/8	5/8	5/8-11	.020	24	6,000 – 15,000	15,000	10	79182749	82749
6	5/8	1-1/8	5/8-11	.016	32	3,500 – 9,000	9,000	10	79182752	82752
				.023	32	3,500 – 9,000	9,000	10	79182753	82753

# Wheel brushes

## Knotted

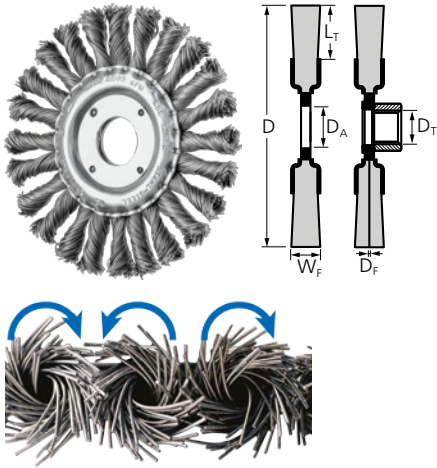

### Full cable twist, COMBITWIST®

Very aggressive brush. Designed for heavy-duty brushing in metalwork such as descaling, derusting, deburring, cleaning of weld seams and removal of adhesive residues and spatter. Good for work on corners and edges as the knots are less likely to unravel.



#### Special features:

- Maximum economic efficiency due to maximum service life and stock removal rate.
- Brush runs smoothly due to its flawless balance.
- Aggressive brushing action due to tightly-twisted wire knots.

D [Inch]	W <sub>F</sub> [Inch]	L <sub>T</sub> [Inch]	D <sub>A</sub> / D <sub>T</sub>	D <sub>F</sub> [Inch]	Knots	Opt. RPM	Max. RPM		Item no.	EDP no.
<b>Steel wire (ST)</b>										
4	1/2	3/4	5/8-11	.014	22	10,000 – 15,000	20,000	10	79182387	82387
				.020	22	10,000 – 15,000	20,000	10	79182388	82388
5	1/2	3/4	5/8-11	.023	24	7,500 – 15,000	15,000	10	79182684	82684
6	1/2	1-1/4	5/8-11	.023	30	5,000 – 10,000	10,000	10	79182688	82688
<b>Stainless steel wire (INOX)</b>										
4	1/2	3/4	5/8-11	.020	32	8,000 – 15,000	20,000	10	79182420	82420
				.014	22	8,000 – 15,000	20,000	10	79182416	82416
				.020	22	8,000 – 15,000	20,000	10	79182417	82417
4-1/2	3/16	1	5/8-11	.020	32	8,000 – 15,000	20,000	10	79182421	82421
4-7/8	3/16	3/4	5/8-11	.020	48	7,000 – 15,000	15,000	10	79182759	82759
6	3/16	1-1/8	5/8-11	.020	48	5,000 – 12,500	12,500	10	79182763	82763
					56	5,000 – 12,500	12,500	10	79182764	82764





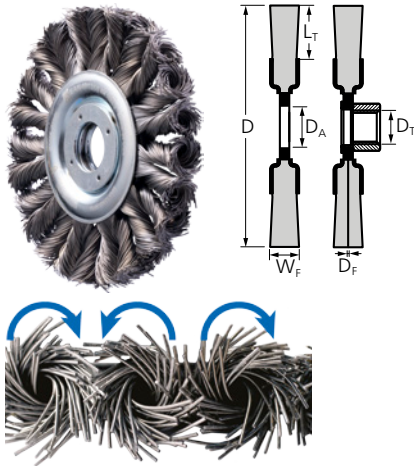

### Full cable twist, COMBITWIST® HD

With a higher filament density and more wire filament, the tool life is at least three times longer and stock removal is improved. Suitable for heavy-duty brushing in metalwork such as descaling, derusting, deburring, cleaning of weld seams and removal of adhesive residues and spatter.

#### Special features:

- Extremely high filament density for optimum tool life.
- High level of comfort thanks to smooth running with no brush recoiling on corners and edges.
- Aggressive brushing action due to tightly-twisted wire knots.

D [Inch]	W <sub>F</sub> [Inch]	L <sub>T</sub> [Inch]	D <sub>A</sub> / D <sub>T</sub>	D <sub>F</sub> [Inch]	Knots	Opt. RPM	Max. RPM		Item no.	EDP no.
<b>Steel wire (ST)</b>										
4-1/2	1/2	7/8	5/8-11	.020	24	6,300 – 12,500	12,500	1	<a href="#">43317018</a>	82395
5	1/2	1-1/8	5/8-11	.020	24	5,500 – 12,500	12,500	1	<a href="#">79182397</a>	82397
6	1/2	1-1/8	5/8-11	.020	30	5,000 – 10,000	10,000	1	<a href="#">43317032</a>	82339
7	1/2	1-5/8	5/8-11	.020	30	4,500 – 8,500	9,000	1	<a href="#">43317038</a>	82400
<b>Stainless steel wire (INOX) – These INOX brushes are degreased.</b>										
4-1/2	1/2	7/8	5/8-11	.014	24	5,000 – 12,500	12,500	1	<a href="#">79182396</a>	82396
5	1/2	1-1/8	5/8-11	.014	24	4,400 – 12,500	12,500	1	<a href="#">43317019</a>	82398
6	1/2	1-1/8	5/8-11	.014	30	4,000 – 10,000	10,000	1	<a href="#">43317035</a>	82403
7	1/2	1-5/8	5/8-11	.014	30	3,600 – 8,500	9,000	1	<a href="#">43317041</a>	82404

## Pipeline

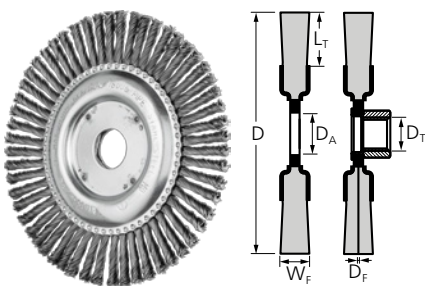

### Stringer bead twist

Aggressive and robust brush that is able to withstand high mechanical loads. Ideal for heavy-duty brushing in pipeline and container construction.



#### Special features:

- Extra-slim design allows access to hard-to-reach areas such as root weld seams.
- Aggressive brushing action due to tightly-twisted wire knots.

D [Inch]	W <sub>F</sub> [Inch]	L <sub>T</sub> [Inch]	D <sub>A</sub> / D <sub>T</sub>	D <sub>F</sub> [Inch]	Knots	Opt. RPM	Max. RPM		Item no.	EDP no.
<b>Steel wire (ST)</b>										
4	3/16	3/4	5/8-11	.020	32	10,000 – 15,000	20,000	5	<a href="#">79184825</a>	82186P
								10	<a href="#">79182186</a>	82186
			M10x1,25	.020	32	10,000 – 15,000	20,000	5	<a href="#">79184827</a>	82190P
								10	<a href="#">79182190</a>	82190

Continued on next page

# Wheel brushes

## Pipeline



D [Inch]	W <sub>F</sub> [Inch]	L <sub>T</sub> [Inch]	D <sub>A</sub> / D <sub>T</sub>	D <sub>F</sub> [Inch]	Knots	Opt. RPM	Max. RPM		Item no.	EDP no.		
4	3/16	3/4	3/8-24	.020	32	10,000 – 15,000	20,000	10	79182188	82188		
			1/2-13	.020	32	10,000 – 15,000	20,000	5	79184826	82187P		
									10	79182187	82187	
			3/8	.020	32	10,000 – 15,000	20,000	10	79182193	82193		
			X-LOCK	.020	32	10,000 – 15,000	20,000	1	79180710	80710		
4-1/2	3/16	1	5/8-11	.020	32	10,000 – 15,000	20,000	5	79152194	82194P		
								10	79182194	82194		
			X-LOCK	.020	32	6,300 – 12,500	12,500	1	43302111	80711		
4-7/8	3/16	3/4	5/8-11	.020	38	7,500 – 15,000	15,000	10	79182479	82479		
					48	7,500 – 15,000	15,000	5	79184875	82483P		
								10	79182483	82483		
			X-LOCK	.020	38	6,300 – 12,500	12,500	1	43302521	80412		
6	1/8	1-1/8	5/8-11	.020	64	6,000 – 12,500	12,500	10	79182489	82489		
										5	79152488	82488P
	3/16	1-1/8	5/8-11	.020	56	6,000 – 12,500	12,500	10	79182486	82486		
					48	6,000 – 12,500	12,500	5	79184877	82487P		
										10	79182487	82487
					56	6,000 – 12,500	12,500	10	79182488	82488		
6-7/8	3/16	1-1/8	5/8-11	.020	56	4,500 – 9,000	9,000	10	79182494	82494		
					76	4,500 – 9,000	9,000	10	79182495	82495		
<b>Stainless steel wire (INOX)</b>												
4	3/16	3/4	5/8-11	.020	32	8,000 – 15,000	20,000	5	79184831	82307P		
								10	79182307	82307		
4 1/2	3/16	1	5/8-11	.020	32	8,000 – 15,000	20,000	10	79182315	82315		
4	3/16	3/4	3/8-24	.020	32	8,000 – 15,000	20,000	10	79182309	82309		
4-7/8	3/16	3/4	5/8-11	.020	38	6,000 – 15,000	15,000	10	79182604	82604		
					48	6,000 – 15,000	15,000	10	79182608	82608		
6	3/16	1-1/8	5/8-11	.020	40	5,000 – 12,500	12,500	10	79182611	82611		
					48	5,000 – 12,500	12,500	5	79184881	82612P		
										10	79182612	82612
					56	5,000 – 12,500	12,500	10	79182613	82613		
6-7/8	3/16	1-1/8	5/8-11	.020	56	3,500 – 9,000	9,000	10	79182619	82619		
					76	3,500 – 9,000	9,000	10	79182728	82728		
<b>Stainless steel wire (INOX) – These INOX brushes are degreased.</b>												
4	3/16	3/4	X-LOCK	.020	32	8,000 – 15,000	20,000	1	79180425	80425		



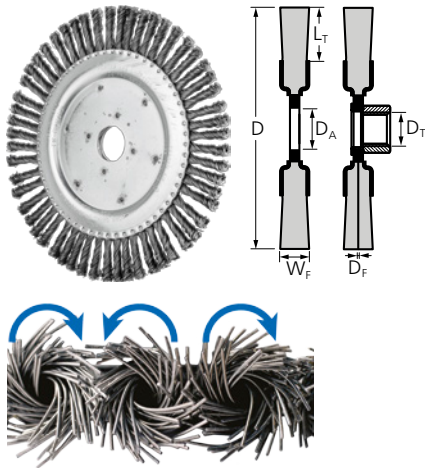

### Stringer bead twist, COMBITWIST®

Very aggressive and robust brush that is able to withstand high mechanical loads. Perfect for heavy-duty brushing in pipeline and container construction. Designed for work on corners and edges as the knots are less likely to unravel.

#### Special features:

- Extra-slim design allows access to hard-to-reach areas such as root weld seams.
- Maximum economic efficiency due to maximum tool life and stock removal rate. High level of comfort thanks to smooth running with no brush recoiling.
- Aggressive brushing action due to tightly-twisted wire knots.

D [Inch]	W <sub>F</sub> [Inch]	L <sub>T</sub> [Inch]	D <sub>A</sub> / D <sub>T</sub>	D <sub>F</sub> [Inch]	Knots	Opt. RPM	Max. RPM		Item no.	EDP no.
<b>Steel wire (ST)</b>										
4	3/16	3/4	5/8-11	.020	32	10,000 – 15,000	20,000	10	79182391	82391
4-1/2	3/16	1	5/8-11	.020	32	10,000 – 15,000	20,000	10	79182392	82392
4-7/8	3/16	3/4	5/8-11	.020	48	7,500 – 15,000	15,000	10	79182689	82689
6	3/16	1-1/8	5/8-11	.020	48	6,000 – 12,500	12,500	10	79182693	82693
					56	6,000 – 12,500	12,500	10	79182694	82694
6-7/8	3/16	1-1/8	5/8-11	.020	56	4,500 – 9,000	9,000	10	79182700	82700
					76	4,500 – 9,000	9,000	10	79182701	82701

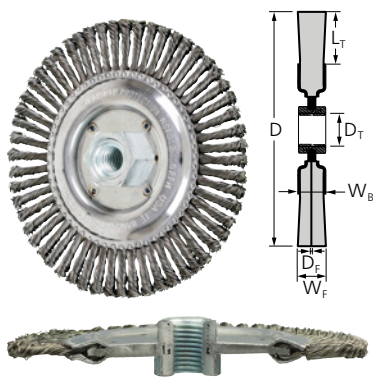

### TWIN-NUT, stringer bead twist

Very aggressive and robust brush that is able to withstand high mechanical loads. Ideal for heavy-duty brushing in pipeline and container construction. The design of the thread prevents the brush from coming into contact with the protective cover of the angle grinder.

#### Special features:

- The change of knot twist direction gives the brush a longer service life and aggressive properties.
- Extra-slim design allows access to hard-to-reach areas such as root weld seams.
- Aggressive brushing action due to tightly-twisted wire knots.

D [Inch]	W <sub>F</sub> [Inch]	L <sub>T</sub> [Inch]	D <sub>F</sub> [Inch]	Knots	Opt. RPM	Max. RPM		Item no.	EDP no.
<b>Steel wire (ST)</b>									
6	3/16	1-1/8	.020	48	6,000 – 12,500	12,500	10	79188028	88028
				56	6,000 – 12,500	12,500	10	79188029	88029
6-7/8	3/16	1-1/8	.020	56	4,500 – 9,000	9,000	10	79188032	88032
<b>Stainless steel wire (INOX) – These INOX brushes are degreased.</b>									
6	3/16	1-1/8	.020	48	5,000 – 12,500	12,500	10	79188041	88041
6-7/8	3/16	1-1/8	.020	56	3,500 – 9,000	9,000	10	79188044	88044

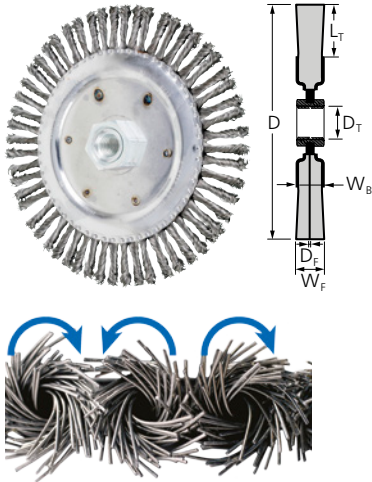

### TWIN-NUT, stringer bead twist COMBITWIST®

Very aggressive and robust brush that is able to withstand high mechanical loads. Ideal for heavy-duty brushing in pipeline and container construction. The design of the thread prevents the brush from coming into contact with the protective cover of the angle grinder.

#### Special features:

- The change of knot twist direction gives the brush a longer service life and aggressive properties.
- Maximum economic efficiency due to maximum tool life and stock removal rate. High level of comfort thanks to smooth running with no brush recoiling.
- Extra-slim design allows access to hard-to-reach areas such as root weld seams.

D [Inch]	W <sub>F</sub> [Inch]	L <sub>T</sub> [Inch]	D <sub>F</sub> [Inch]	Knots	Opt. RPM	Max. RPM		Item no.	EDP no.
<b>Steel wire (ST)</b>									
4-7/8	3/16	3/4	.020	48	5,000 – 12,500	12,500	5	79188049	88049
6	3/16	1-1/8	.020	56	6,000 – 12,500	12,500	10	79188050	88050
6-7/8	3/16	1-1/8	.020	56	4,500 – 9,000	9,000	10	79188052	88052
6	3/16	1-1/8	.020	56	5,000 – 12,500	12,500	10	79188042	88042

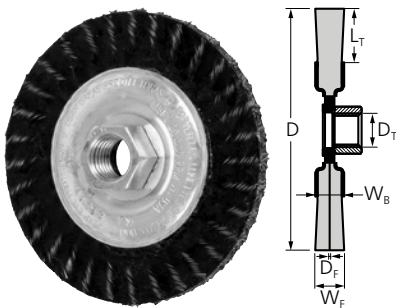

### Stringer bead twist, ECAP® encapsulated

Extremely aggressive brushing action, ideal for heavy-duty brushing in pipeline and container construction.

#### Special features:

- Maximum service life as premature wire breakage is prevented.
- Precise handling due to high dimensional stability.
- Extra-slim design allows access to hard-to-reach areas such as root weld seams.

D [Inch]	W <sub>F</sub> [Inch]	L <sub>T</sub> [Inch]	ECAP® grade	D <sub>F</sub> [Inch]	Opt. RPM	Max. RPM		Item no.	EDP no.
<b>Steel wire (ST)</b>									
4	3/16	7/8	E4	.020	10,000 – 15,000	20,000	10	79183511	83511
6	3/16	1-1/16	E4	.014	4,500 – 9,000	9,000	10	79183507	83507
7	3/16	1-9/16	E4	.014	4,500 – 9,000	9,000	10	79183509	83509
			E5	.014	4,500 – 9,000	9,000	10	79183517	83517
6-7/8	3/16	1-9/16	E4	.020	4,500 – 9,000	9,000	10	79183513	83513



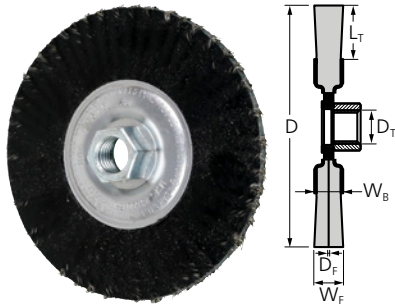

### J-BEVEL, stringer bead twist, ECAP® encapsulated

Designed for working on weld seams that are produced through automatic welding processes.

**Special features:**

- Maximum service life as premature wire breakage is prevented.
- Precise handling due to high dimensional stability.
- Extra-slim design allows access to hard-to-reach areas such as root weld seams.

D [Inch]	W <sub>F</sub> [Inch]	L <sub>T</sub> [Inch]	ECAP® grade	D <sub>F</sub> [Inch]	Opt. RPM	Max. RPM		Item no.	EDP no.
<b>Steel wire (ST)</b>									
5	3/16	1-1/4	E4	.014	7,500 – 15,000	15,000	10	79183515	83515

## Knot wheels

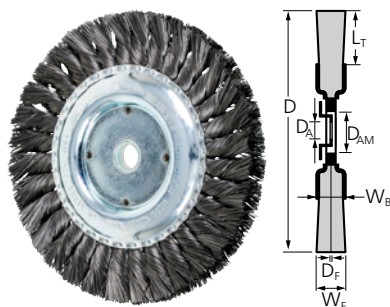

### Standard twist, single row, long flag

The knots of the brush are twisted to 50% of the length. The brush achieves a better surface quality on uneven surfaces than conventional knotted brushes.

**Special features:**

- Optimal ratio of aggressiveness and flexibility.

D [Inch]	W <sub>F</sub> [Inch]	L <sub>T</sub> [Inch]	W <sub>B</sub> [Inch]	D <sub>AM</sub> [Inch]	D <sub>A</sub> [Inch]	D <sub>F</sub> [Inch]	Knots	Opt. RPM	Max. RPM		Item no.	EDP no.
<b>Steel wire (ST)</b>												
6	5/8	1-1/8	9/16	5/8	1/2	.014	32	4,500 – 6,500	9,000	10	79181881	81881

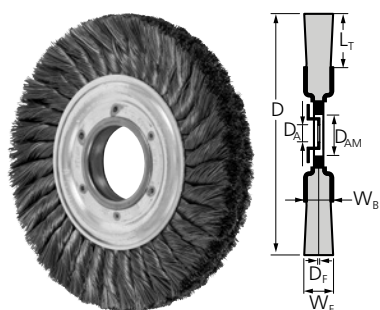

### Standard twist, double row, long flag

The knots of the brush are twisted to 50% of the length. The brush achieves a better surface quality on uneven surfaces than conventional knotted brushes.

**Special features:**

- Double-row design enables fast results due to larger filament width.
- Optimal ratio of aggressiveness and flexibility.

D [Inch]	W <sub>F</sub> [Inch]	L <sub>T</sub> [Inch]	W <sub>B</sub> [Inch]	D <sub>AM</sub> [Inch]	D <sub>A</sub> [Inch]	D <sub>F</sub> [Inch]	Knots	Opt. RPM	Max. RPM		Item no.	EDP no.
<b>Steel wire (ST)</b>												
4	1	3/4	1-1/8	5/8	1/2	.014	44	6,000 – 12,000	20,000	5	79182032	82032
10	1-1/4	2-1/8	1-1/4	2	2	.016	100	2,500 – 3,500	4,800	1	79182039	82039

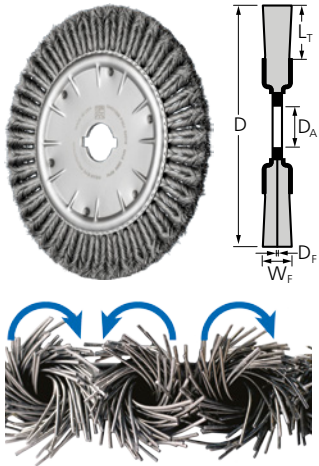

### Full cable twist, single row COMBITWIST®

Extremely aggressive brush that is able to withstand significant mechanical loads. Suitable for any heavy-duty stationary or automated brushing, e.g. deburring work. Excellent for work on corners and edges as the knots are less likely to unravel.

#### Special features:

- Maximum economic efficiency due to maximum tool life and stock removal rate. High level of comfort thanks to smooth running with no brush recoiling.
- Aggressive brushing action due to tightly-twisted wire knots.
- Can be used with all common stationary drive systems and bench grinders.

D [Inch]	W <sub>F</sub> [Inch]	L <sub>T</sub> [Inch]	D <sub>A</sub> [Inch]	D <sub>F</sub> [Inch]	Knots	Opt. RPM	Max. RPM		Item no.	EDP no.
<b>Steel wire (ST)</b>										
14	3/4	2-1/4	2	.020	80	700 – 3,000	3,600	1	79182019	82019
15	3/4	2-5/8	2	.020	80	700 – 3,000	3,600	1	79182020	82020

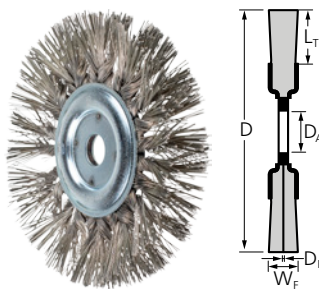

### Diamond coated, standard twist

INOX DIA filament brushes are designed for particularly demanding applications that require an aggressive brush. They are primarily used on extremely hard materials.

#### Special features:

- The knots of the brush are twisted to 50% of the length, ensuring an optimal ratio of aggressiveness and flexibility.
- The brush achieves a better surface quality on uneven surfaces when compared to knotted brushes.

D [Inch]	W <sub>F</sub> [Inch]	L <sub>T</sub> [Inch]	D <sub>A</sub> [Inch]	Grit size	D <sub>F</sub> [Inch]	Knots	Opt. RPM	Max. RPM		Item no.	EDP no.
<b>Stainless steel wire (INOX) diamond (DIA)</b>											
7-1/2	1-1/4	2	1-1/4	270	.020	24	1,000 – 2,000	8,000	1	79184354	84354
				400	.020	24	1,000 – 2,000	8,000	1	79184355	84355

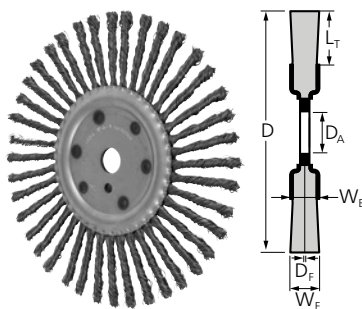

### Expansion joint cleaning

For brushing out loose and semi-solid substances, such as stone, grit and dross from joints and expansion joints in road and airport construction.

#### Special features:

- Aggressive brushing effect due to the very stiff knotted wire.
- Extra-slim design enables optimal access to hard-to-reach areas such as joints.

D [Inch]	W <sub>F</sub> [Inch]	L <sub>T</sub> [Inch]	W <sub>B</sub> [Inch]	D <sub>A</sub> [Inch]	D <sub>F</sub> [Inch]	Knots	Opt. RPM	Max. RPM		Item no.	EDP no.
<b>Steel wire (ST)</b>											
12	3/8	3	1/2	1	.035	40	2,000 – 3,000	6,000	2	79182078	82078

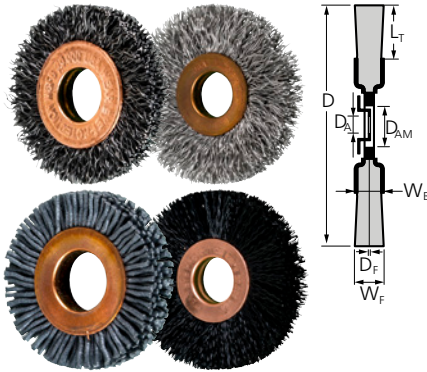

### Small diameter copper center

Designed for cleaning, derusting, smoothing, cleaning of weld seams, light deburring, and removal of corrosion and paint.

#### Special features:

- Highly flexible, enabling optimal adaptation to the workpiece contour.
- The special design enables several brushes to be packaged in a row to create wide gap-less rollers.

D [Inch]	W <sub>F</sub> [Inch]	W <sub>B</sub> [Inch]	L <sub>T</sub> [Inch]	D <sub>A</sub> [Inch]	D <sub>AM</sub> [Inch]	Grit size	D <sub>F</sub> [Inch]	Opt. RPM	Max. RPM		Item no.	EDP no.
<b>Steel wire (ST)</b>												
1-1/4	1/4	7/32	3/8	1/4	3/8	-	.008	10,000 – 15,000	20,000	10	79181504	81504
1-1/2	1/4	7/32	7/16	3/8	-	-	.008	10,000 – 15,000	20,000	10	79181515	81515
							.012	10,000 – 15,000	20,000	10	79181517	81517
2	3/8	7/32	1/2	3/8	1/2	-	.008	10,000 – 15,000	20,000	10	79181527	81527
							.012	10,000 – 15,000	20,000	10	79181529	81529
							.014	10,000 – 15,000	20,000	10	79181530	81530
2-1/2	1/2	5/16	3/4	3/8	1/2	-	.012	10,000 – 15,000	20,000	10	79181534	81534
							.014	10,000 – 15,000	20,000	10	79181535	81535
3	5/8	5/16	1	3/8	1/2	-	.006	10,000 – 15,000	20,000	10	79181542	81542
							.008	10,000 – 15,000	20,000	10	79181543	81543
							.012	10,000 – 15,000	20,000	10	79181545	81545
							.014	10,000 – 15,000	20,000	10	79181546	81546
4	1/2	5/16	1-1/2	5/8	-	-	.008	5,000 – 7,500	10,000	10	79181553	81553
<b>Stainless steel wire (INOX)</b>												
2	3/8	7/32	1/2	3/8	1/2	-	.006	8,000 – 13,000	20,000	10	79181575	81575
							.012	8,000 – 13,000	20,000	10	79181578	81578
3	5/8	5/16	1	3/8	1/2	-	.006	8,000 – 13,000	20,000	10	79181586	81586
							.008	8,000 – 13,000	20,000	10	79181587	81587
							.012	8,000 – 13,000	20,000	10	79181589	81589
							.014	8,000 – 13,000	20,000	10	79181590	81590
<b>Nylon plastic filament</b>												
2	3/8	7/32	1/2	1/2	-	-	.014	5,200 – 9,000	20,000	10	79184340	84340
3	3/8	5/16	1	1/2	-	-	.016	5,200 – 9,000	20,000	10	79184343	84343
<b>M-BRAD® nylon abrasive filament, silicon carbide SiC</b>												
1-1/2	3/8	7/32	7/16	3/8	1/2	180	.035	4,000 – 6,000	10,000	10	79183782	83782
2	5/8	7/32	1/2	3/8	1/2	320	.022	4,000 – 6,000	10,000	10	79183785	83785
2-1/2	5/8	5/16	11/16	5/8	-	320	.022	4,000 – 6,000	10,000	10	79183792	83792
3	5/8	5/16	15/16	3/8	1/2	180	.035	4,000 – 6,000	10,000	10	79183794	83794
						120	.040	4,000 – 6,000	10,000	10	79183793	83793

# Wheel brushes

## Crimped, unthreaded

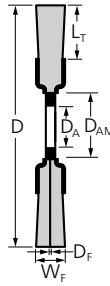
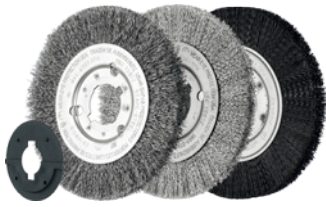

### Narrow face

Excellent for medium-duty hand-held or automated brushing of large workpieces.

#### Special features:

- Can be used with all common stationary drive systems and bench grinders.
- The special design enables bunching to create wide gapless rollers. This enables a uniform surface finish to be achieved.
- Highly flexible, enabling optimal adaptation to the workpiece contour.

D [Inch]	W <sub>F</sub> [Inch]	W <sub>B</sub> [Inch]	L <sub>T</sub> [Inch]	D <sub>A</sub> [Inch]	D <sub>AM</sub> [Inch]	Grit size	D <sub>F</sub> [Inch]	Opt. RPM	Max. RPM		Item no.	EDP no.
<b>Steel wire (ST)</b>												
3	9/16	7/16	3/4	3/8	1/2	-	.014	5,000 – 7,500	10,000	2	79180003	80003
4	1/2	7/16	3/4	3/8	1/2	-	.008	6,000 – 9,000	12,500	2	79181442	81442
							.012	6,000 – 9,000	12,500	2	79180017	80017
							.014	6,000 – 9,000	12,500	2	79180018	80018
6	5/8	7/16	1-1/8	1/2	5/8	-	.006	4,000 – 6,000	8,000	10	79180038	80038
							.008	4,000 – 6,000	8,000	5	79150039	80039P
							.008	4,000 – 6,000	8,000	10	79180039	80039
							.010	4,000 – 6,000	8,000	10	79180040	80040
							.012	4,000 – 6,000	8,000	10	79180041	80041
							.014	4,000 – 6,000	8,000	5	79150042	80042P
8	5/8	5/8	1-1/2	5/8	-	-	.006	3,000 – 4,500	6,000	2	79180158	80158
							.008	3,000 – 4,500	6,000	2	79180159	80159
							.012	3,000 – 4,500	6,000	2	79180161	80161
							.012	3,000 – 4,500	6,000	2	79180167	80167
							.014	3,000 – 4,500	6,000	2	79180162	80162
10	1	1/2	1-7/8	1-1/4	-	-	.008	2,000 – 3,000	4,200	2	79180225	80225
							.014	2,000 – 3,000	4,200	2	79180228	80228
							.012	1,500 – 2,500	3,400	2	79180283	80283
12	1-1/4	11/16	2-7/8	1-1/4	-	-	.014	1,500 – 2,500	3,400	2	79180284	80284
<b>Stainless steel wire (INOX)</b>												
4	1/2	7/16	3/4	1/2	5/8	-	.006	5,000 – 8,000	12,500	2	79180344	80344
							.012	5,000 – 8,000	12,500	2	79180347	80347
6	5/8	7/16	1-1/8	1/2	5/8	-	.006	3,000 – 5,000	8,000	2	79180368	80368
							.008	3,000 – 5,000	8,000	2	79180369	80369
							.010	3,000 – 5,000	8,000	2	79180370	80370
							.012	3,000 – 5,000	8,000	2	79180371	80371
8	3/4	1/2	2-1/8	5/8	-	-	.006	2,000 – 4,000	6,000	2	79180518	80518
							.012	2,000 – 4,000	6,000	2	79180491	80491
							.012	2,000 – 4,000	6,000	2	79180497	80497
10	1	1/2	1-7/8	1-1/4	-	-	.012	1,500 – 2,500	4,200	2	79180557	80557
<b>Brass wire</b>												
6	5/8	7/16	1-1/8	1/2	5/8	-	.008	3,000 – 5,000	8,000	2	79180666	80666
							.014	3,000 – 5,000	8,000	2	79180667	80667
8	3/4	1/2	1-1/2	1-1/4	-	-	.008	2,000 – 4,000	6,000	2	79180682	80682

Continued on next page



D [Inch]	W <sub>F</sub> [Inch]	W <sub>B</sub> [Inch]	L <sub>T</sub> [Inch]	D <sub>A</sub> [Inch]	D <sub>AM</sub> [Inch]	Grit size	D <sub>F</sub> [Inch]	Opt. RPM	Max. RPM		Item no.	EDP no.
<b>M-BRAD® nylon abrasive filament, silicon carbide SiC</b>												
4	3/4	3/4	3/4	1/2	5/8	80	.040	3,000 – 5,000	12,500	2	79183680	83680
						120	.040	3,000 – 5,000	12,500	2	79183681	83681
						180	.035	3,000 – 5,000	12,500	2	79183682	83682
						320	.022	3,000 – 5,000	12,500	2	79183683	83683
<b>M-BRAD® nylon abrasive filament, ceramic oxide (CO)</b>												
4	1/4	3/4	3/4	1/2	5/8	80	.040	3,000 – 5,000	12,500	2	79184225	84225
						120	.022	3,000 – 5,000	12,500	2	79184226	84226
							.040	3,000 – 5,000	12,500	2	79184227	84227
<b>Nylon plastic filament</b>												
6	3/4	7/16	1-1/2	1-1/4	-	-	.016	1,500 – 2,500	6,000	2	79184344	84344

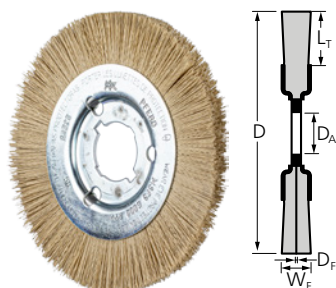

### Crimped wheel

Diamond (DIA) filament brushes are designed for particularly demanding applications. Excellent for hand-held or automated brushing of workpieces with large surfaces.

#### Special features:

- Can be used with all common stationary drive systems and bench grinders.
- The special design enables bunching to create wide gapless rollers. This enables a uniform surface finish to be achieved.
- Highly flexible, enabling optimal adaptation to the workpiece contour.

D [Inch]	W <sub>F</sub> [Inch]	W <sub>B</sub> [Inch]	L <sub>T</sub> [Inch]	D <sub>A</sub> [Inch]	Grit size	D <sub>F</sub> [Inch]	Opt. RPM	Max. RPM		Item no.	EDP no.
<b>M-BRAD® nylon abrasive filament, Diamond grain DIA</b>											
4	1/2	1/2	3/4	5/8	600	.014	2,000 – 5,000	12,000	1	79184325	84325
6	1/2	1/2	1-1/8	1-1/4	600	.014	1,000 – 3,500	6,000	1	79184323	84323
8	1/2	1/2	1-1/2	2	600	.014	900 – 1,500	4,500	1	79184322	84322

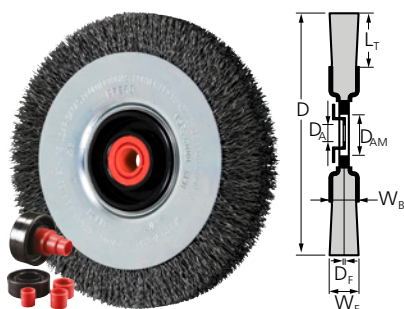

### EZmount® bench wheels

Designed for light and medium-duty brushing in stationary application. Robust wheel brush with short, dense filament for universal application in the workshop. Variable bore diameters enable application on all standard stationary drive systems. Developed for use on bench grinders.

#### Special features:

- Highly flexible, enabling optimal adaptation to the workpiece contour.
- Can be used with all common stationary drive systems and bench grinders.

D [Inch]	W <sub>F</sub> [Inch]	L <sub>T</sub> [Inch]	W <sub>B</sub> [Inch]	D <sub>A</sub> [Inch]	D <sub>AM</sub> [Inch]	D <sub>F</sub> [Inch]	Opt. RPM	Max. RPM		Item no.	EDP no.
<b>Steel wire (ST)</b>											
6	7/8	7/8	3/4	1	2	.014	3,000 – 4,500	6,000	5	79184721	81474P
									1	79181474	81474
8	7/8	7/8	3/4	1	2	.014	2,000 – 3,000	4,500	5	79184723	81478P
									1	79181478	81478
10	7/8	2-1/4	3/4	1	2	.014	1,500 – 2,500	3,600	1	79181480	81480

# Wheel brushes

## Crimped, unthreaded

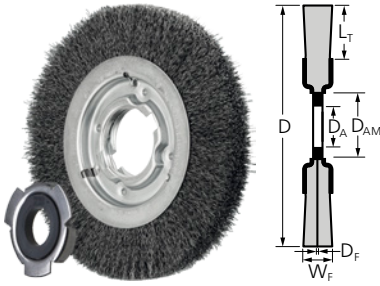

### Medium face

Excellent for medium-duty hand-held or automated brushing of workpieces with large surfaces. Developed specially for industrial use. The brush impresses with its very long tool life, which ensures high economic efficiency.



#### Special features:

- Can be used with all common stationary drive systems and bench grinders.
- The special design enables bunching to create wide gapless rollers. This enables a uniform surface finish to be achieved.
- Highly flexible, enabling optimal adaptation to the workpiece contour.

D [Inch]	W <sub>F</sub> [Inch]	L <sub>T</sub> [Inch]	D <sub>A</sub> [Inch]	D <sub>AM</sub> [Inch]	Grit size	D <sub>F</sub> [Inch]	Opt. RPM	Max. RPM		Item no.	EDP no.	
<b>Steel wire (ST)</b>												
6	1-1/16	1-1/8	1-1/4	2	-	.006	3,000 – 4,500	6,000	1	79181112	81112	
						.008	3,000 – 4,500	6,000	1	79181113	81113	
						.010	3,000 – 4,500	6,000	1	79181114	81114	
						.012	3,000 – 4,500	6,000	1	79181115	81115	
						.014	3,000 – 4,500	6,000	5	79151116	81116P	
									1	79181116	81116	
		1-1/8	1-1/8	1-1/4	2	-	.006	3,000 – 4,500	6,000	1	79181232	81232
	.012						3,000 – 4,500	6,000	1	79181235	81235	
	.014						3,000 – 4,500	6,000	1	79181236	81236	
	7	1	1-5/16	1-1/4	2	-	.010	3,000 – 4,500	6,000	1	79181120	81120
.012							3,000 – 4,500	6,000	1	79181121	81121	
.014							3,000 – 4,500	6,000	5	79151122	81122P	
								1	79181122	81122		
8	1	1-1/2	1-1/4	2	-	.010	2,300 – 3,400	4,500	1	79181126	81126	
						.012	2,300 – 3,400	4,500	1	79181127	81127	
						.014	2,300 – 3,400	4,500	1	79151128	81128P	
										79181128	81128	
						.020	2,300 – 3,400	4,500	1	79181129	81129	
		1-3/8	1-1/2	1-1/4	2	-	.006	2,300 – 3,400	4,500	1	79181244	81244
	.012						2,300 – 3,400	4,500	1	79181247	81247	
	.014						2,300 – 3,400	4,500	1	79181248	81248	
	.020						2,300 – 3,400	4,500	1	79181249	81249	
10	1-1/4	1-7/8	1-1/4	2	-	.014	1,800 – 2,700	3,600	1	79181134	81134	
						.012	1,800 – 2,700	3,600	1	79181133	81133	
						.020	1,800 – 2,700	3,600	1	79181135	81135	
						.010	1,800 – 2,700	3,600	1	79181252	81252	
		2	1-7/8	1-1/4	2	-	.012	1,800 – 2,700	3,600	1	79181253	81253
	.014						1,800 – 2,700	3,600	1	79181254	81254	
	.020						1,800 – 2,700	3,600	1	79181255	81255	
12	1-1/2	2-7/8	1-1/4	2	-	.012	1,500 – 2,500	3,000	1	79181138	81138	
	2-1/4	2-7/8	1-1/4	2	-	.012	1,500 – 2,500	3,000	1	79181257	81257	

Continued on next page



D [Inch]	W <sub>F</sub> [Inch]	L <sub>T</sub> [Inch]	D <sub>A</sub> [Inch]	D <sub>AM</sub> [Inch]	Grit size	D <sub>F</sub> [Inch]	Opt. RPM	Max. RPM		Item no.	EDP no.
12	2-1/4	2-7/8	1-1/4	2	-	.014	1,500 – 2,500	3,000	1	79181258	81258
	1-1/2	2-7/8	1-1/4	2	-	.020	1,500 – 2,500	3,000	1	79181140	81140
	2-1/4	2-7/8	1-1/4	2	-	.020	1,500 – 2,500	3,000	1	79181259	81259
	1-1/2	2-7/8	1-1/4	2	-	.014	1,500 – 2,500	3,000	1	79181139	81139
15	2-1/2	3-1/8	1-1/4	2	-	.012	1,000 – 1,800	2,400	1	79181261	81261
<b>Stainless steel wire (INOX)</b>											
6	1-1/16	1-1/8	1-1/4	2	-	.006	2,400 – 3,900	6,000	1	79181157	81157
						.010	2,400 – 3,900	6,000	1	79181159	81159
						.012	2,400 – 3,900	6,000	1	79181160	81160
	1-1/8	1-1/8	1-1/4	2	-	.014	2,400 – 3,900	6,000	1	79181280	81280
8	1	1-1/2	1-1/4	2	-	.006	1,800 – 2,900	4,500	1	79181169	81169
						.012	1,800 – 2,900	4,500	1	79181172	81172
						.014	1,800 – 2,900	4,500	1	79181173	81173
						.012	1,800 – 2,900	4,500	1	79181291	81291
10	1-1/4	1-7/8	1-1/4	2	-	.012	1,400 – 2,300	3,600	1	79181178	81178
	2	1-7/8	1-1/4	2	-	.012	1,400 – 2,300	3,600	1	79181297	81297
12	1-3/4	2-7/8	1-1/4	2	-	.014	1,200 – 1,900	3,000	1	79181184	81184
<b>M-BRAD® nylon abrasive filament, silicon carbide SiC</b>											
6	7/8	1-1/8	1-1/4	2	80	.040	1,500 – 2,500	6,000	1	79183699	83699
					120	.040	1,500 – 2,500	6,000	1	79183700	83700
					180	.035	1,500 – 2,500	6,000	1	79183701	83701
					320	.022	1,500 – 2,500	6,000	1	79183702	83702
8	1	1-1/2	1-1/4	2	80	.040	1,200 – 2,000	4,500	1	79183703	83703
					120	.040	1,200 – 2,000	4,500	1	79183704	83704
					180	.035	1,200 – 2,000	4,500	1	79183705	83705
					320	.022	1,200 – 2,000	4,500	1	79183706	83706
<b>M-BRAD® nylon abrasive filament, ceramic oxide (CO)</b>											
4	3/4	7/8	1/2	5/8	120	.022	3,000 – 5,000	12,000	1	79184213	84213
						.040	3,000 – 5,000	12,000	1	79184211	84211

# Composite brushes

## Wheel brushes, crimped

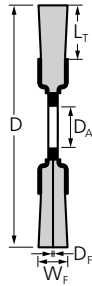

### Composite wheels

Impressively aggressive brush. Its nylon filament makes this product ideal for deburring complicated components such as cylinder heads or gears, as well as for working on surfaces. Developed specially for industrial use.

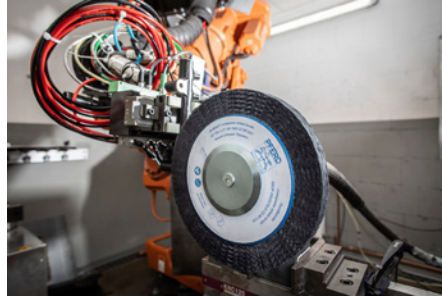

#### Special features:

- Long tool life and aggressive brushing action due to the high filament density.
- Extremely smooth operation due to evenly distributed filament material.

D [Inch]	W <sub>F</sub> [Inch]	L <sub>T</sub> [Inch]	D <sub>A</sub>	Grit size	D <sub>F</sub> [Inch]	Opt. RPM	Max. RPM		Item no.	EDP no.
<b>M-BRAD® nylon abrasive filament, silicon carbide SiC</b>										
6	1	1-1/4	2	80	.040	900 – 1,500	3,600	1	79183720	83720
					.045	900 – 1,500	3,600	1	79183721	83721
				120	.040	900 – 1,500	3,600	1	79183722	83722
				320	.022	900 – 1,500	3,600	1	79183723	83723
8	1	1-1/4	2	80	.040	900 – 1,500	3,600	1	79183726	83726
				120	.040	900 – 1,500	3,600	1	79183728	83728
				320	.022	900 – 1,500	3,600	1	79183729	83729
10	1	1-1/2	2	80	.040	900 – 1,500	3,600	1	79183738	83738
					.045	900 – 1,500	3,600	1	79183739	83739
				120	.022	900 – 1,500	3,600	1	79183742	83742
					.040	900 – 1,500	3,600	1	79183740	83740
12	1	1-1/2	4-1/4	120	.040	500 – 800	1,800	1	79183752	83752
				320	.022	500 – 800	1,800	1	79183753	83753
14	1	1-1/2	5-1/4	80	.040	500 – 800	1,800	1	79183762	83762
					.045	500 – 800	1,800	1	79183763	83763
				120	.040	500 – 800	1,800	1	79183764	83764
				320	.022	500 – 800	1,800	1	79183765	83765
<b>M-BRAD® nylon abrasive filament, ceramic oxide (CO)</b>										
6	1/2	1-1/4	2	80	.040	900 – 1,500	3,600	1	79184118	84118
				120	.040	900 – 1,500	3,600	1	79184119	84119
8	1	1-1/4	2	80	.040	900 – 1,500	3,600	1	79184165	84165
				80	.040	900 – 1,500	3,600	1	79184127	84127
10	1/2	1-1/4	2	80	.040	900 – 1,500	3,600	1	79184132	84132
				120	.040	900 – 1,500	3,600	1	79184132	84132
12	1	1-1/2	2	80	.040	900 – 1,500	3,600	1	79184169	84169
				80	.040	900 – 1,500	3,600	1	79184173	84173
10	1	1-1/2	2	80	.040	500 – 800	1,800	1	79184173	84173
12	1	1-1/2	4-1/4	80	.040	500 – 800	1,800	1	79184177	84177
14	1	1-1/2	5-1/4	80	.040	500 – 800	1,800	1	79184181	84181



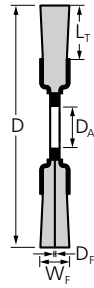

### Composite wheels, FLEX type

Uniquely flexible brush. Its nylon filament makes this product ideal for deburring complicated components such as cylinder heads or gears. Developed specially for industrial use.



#### Special features:

- Long tool life and aggressive brushing action due to the high filament density.
- Extremely smooth operation due to evenly distributed filament material.
- Highly flexible, enabling optimal adjustment to the workpiece contour and less heat build-up.

D [Inch]	W <sub>F</sub> [Inch]	L <sub>T</sub> [Inch]	D <sub>A</sub> [Inch]	Grit size	D <sub>F</sub> [Inch]	Opt. RPM	Max. RPM		Item no.	EDP no.	
<b>M-BRAD® nylon abrasive filament, silicon carbide SiC</b>											
8	1	2-1/4	2	80	.040	900 – 1,500	3,600	1	79183732	83732	
					.045	900 – 1,500	3,600	1	79183733	83733	
				120	.040	900 – 1,500	3,600	1	79183734	83734	
				320	.022	900 – 1,500	3,600	1	79183735	83735	
10	1	2-3/4	2	80	.040	900 – 1,500	3,600	1	79183744	83744	
					.045	900 – 1,500	3,600	1	79183745	83745	
				120	.040	900 – 1,500	3,600	1	79183746	83746	
					.035	900 – 1,500	3,600	1	79183657	83657	
		2-5/8	2	180	.035	900 – 1,500	3,600	1	79183657	83657	
		2-3/4	2	320	.022	900 – 1,500	3,600	1	79183747	83747	
12	1/2	2-3/8	2	320	.022	500 – 800	1,800	1	79184150	84150	
				80	.040	500 – 800	1,800	1	79183659	83659	
	1	3	4-1/2	80	.040	500 – 800	1,800	1	79183756	83756	
					.045	500 – 800	1,800	1	79183757	83757	
			2-3/8	2	120	.040	500 – 800	1,800	1	79183660	83660
				3	4-1/2	120	.040	500 – 800	1,800	1	79183758
			2-3/8	2	180	.035	500 – 800	1,800	1	79183661	83661
				3	4-1/2	320	.022	500 – 800	1,800	1	79183759
14	1	3-1/2	2	80	.040	500 – 800	1,800	1	79183663	83663	
				5-1/4	80	.040	500 – 800	1,800	1	79183768	83768
				.045	500 – 800	1,800	1	79183769	83769		
			120	.040	500 – 800	1,800	1	79183770	83770		
			2	180	.035	500 – 800	1,800	1	79183665	83665	
			5-1/4	320	.022	500 – 800	1,800	1	79183771	83771	
<b>M-BRAD® nylon abrasive filament, ceramic oxide (CO)</b>											
8	1/2	2-1/4	2	80	.040	900 – 1,500	3,600	1	79184124	84124	
				120	.040	900 – 1,500	3,600	1	79184126	84126	
10	1/2	2-5/8	2	80	.040	900 – 1,500	3,600	1	79184133	84133	
				120	.022	900 – 1,500	3,600	1	79184138	84138	
					.040	900 – 1,500	3,600	1	79184139	84139	
12	1/2	2-3/8	2	80	.040	500 – 800	1,800	1	79184144	84144	
				120	.040	500 – 800	1,800	1	79184145	84145	
	1	2-3/8	2	80	.040	500 – 800	1,800	1	79184189	84189	
				120	.040	500 – 800	1,800	1	79184190	84190	
14	1/2	3-1/2	2	80	.040	500 – 800	1,800	1	79184151	84151	
				120	.040	500 – 800	1,800	1	79184152	84152	

Continued on next page

# Composite brushes

## Wheel brushes, crimped



D [Inch]	W <sub>F</sub> [Inch]	L <sub>T</sub> [Inch]	D <sub>A</sub> [Inch]	Grit size	D <sub>F</sub> [Inch]	Opt. RPM	Max. RPM		Item no.	EDP no.
14	1	3-1/2	2	80	.040	500 – 800	1,800	1	79184193	84193
				120	.040	500 – 800	1,800	1	79184194	84194

## Composite disc brushes, crimped

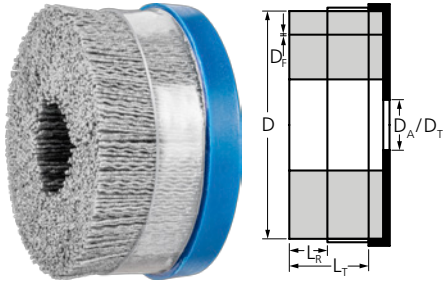

### High density, bridled

M-BRAD® nylon abrasive filament makes this brush ideal for aggressive deburring. Developed specially for industrial use on stationary machines. The removable bridle reduces filament flare for consistently aggressive deburring action.



#### Special features:

- Long tool life and aggressive brushing action due to the high filament density.
- Extremely smooth operation due to evenly distributed filament material.
- If the filament has worn away down to the bridle, the bridle can be removed to extend the life of the brush. This does not affect the brushing behavior.

D [Inch]	L <sub>R</sub> [Inch]	L <sub>T</sub> [Inch]	D <sub>A</sub> / D <sub>T</sub>	Grit size	D <sub>F</sub> [Inch]	Opt. RPM	Max. RPM		Item no.	EDP no.
<b>M-BRAD® nylon abrasive filament, silicon carbide SiC</b>										
3	3/4	1-1/2	7/8	80	.040	2,400 – 3,900	4,500	1	79184120	84120
					.045	2,400 – 3,900	4,500	1	79184121	84121
				120	.040	2,400 – 3,900	4,500	1	79184122	84122
					.022	2,400 – 3,900	4,500	1	79184125	84125
4	3/4	1-1/2	7/8	80	.040	1,400 – 2,300	3,500	1	79184128	84128
					.045	1,400 – 2,300	3,500	1	79184129	84129
				120	.040	1,400 – 2,300	3,500	1	79184130	84130
					.022	1,400 – 2,300	3,500	1	79184131	84131
5	3/4	1-1/2	7/8	80	.040	1,200 – 2,000	3,000	1	79184134	84134
					.045	1,200 – 2,000	3,000	1	79184135	84135
				120	.040	1,200 – 2,000	3,000	1	79184136	84136
					.022	1,200 – 2,000	3,000	1	79184137	84137
6	3/4	1-1/2	7/8	80	.040	1,000 – 1,600	2,500	1	79184140	84140
					.045	1,000 – 1,600	2,500	1	79184141	84141
				120	.040	1,000 – 1,600	2,500	1	79184142	84142
					.022	1,000 – 1,600	2,500	1	79184143	84143
8	-	1-1/2	7/8	80	.040	500 – 800	1,800	1	79184146	84146
					.045	500 – 800	1,800	1	79184147	84147
				120	.040	500 – 800	1,800	1	79184148	84148
					.022	500 – 800	1,800	1	79184149	84149
<b>M-BRAD® nylon abrasive filament, ceramic oxide (CO)</b>										
3	3/4	1-1/2	7/8	80	.040	1,200 – 2,000	4,500	1	79184231	84231
				120	.040	2,400 – 3,900	4,500	1	79184232	84232
4	3/4	1-1/2	7/8	80	.040	1,400 – 2,300	3,500	1	79184236	84236
				120	.040	1,400 – 2,300	3,500	1	79184237	84237
5	3/4	1-1/2	7/8	80	.040	1,200 – 2,000	3,000	1	79184241	84241

Continued on next page

D [Inch]	L <sub>R</sub> [Inch]	L <sub>T</sub> [Inch]	D <sub>A</sub> / D <sub>T</sub>	Grit size	D <sub>F</sub> [Inch]	Opt. RPM	Max. RPM		Item no.	EDP no.
6	3/4	1-1/2	7/8	80	.040	1,000 – 1,600	2,500	1	79184246	84246
<b>Nylon plastic filament</b>										
4	-	1-1/2	7/8	-	.016	1,400 – 2,300	3,500	1	79184268	84268
<b>M-BRAD® nylon abrasive filament, angled</b>										
6	-	1-1/2	7/8	-	.016	1,000 – 1,600	2,500	1	79184269	84269

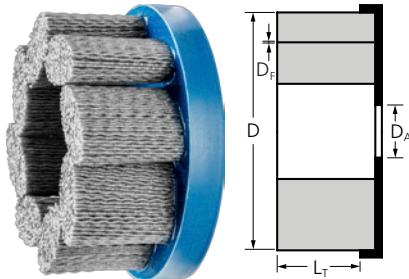

### Standard density, FLEX type

Uniquely flexible brush. Ideal for deburring and work on surfaces. Perfect for use on stationary machines.



#### Special features:

- Long tool life and aggressive brushing action due to the high filament density.
- Extremely smooth operation due to evenly distributed filament material.
- Special arrangement of the filament enables optimal adjustment to the workpiece contour, less heat build-up, and more efficient use of the coolant.

D [Inch]	L <sub>T</sub> [Inch]	D <sub>A</sub> [Inch]	Grit size	D <sub>F</sub> [Inch]	Opt. RPM	Max. RPM		Item no.	EDP no.
<b>M-BRAD® nylon abrasive filament, silicon carbide SiC</b>									
3	1-1/2	7/8	80	.040	2,400 – 3,900	4,500	1	79183941	83941
				.045	2,400 – 3,900	4,500	1	79183966	83966
			120	.040	2,400 – 3,900	4,500	1	79183942	83942
				.035	2,400 – 3,900	4,500	1	79183943	83943
				.022	2,400 – 3,900	4,500	1	79183944	83944
4	1-1/2	7/8	80	.040	1,400 – 2,300	3,500	1	79183945	83945
				.045	1,400 – 2,300	3,500	1	79183968	83968
			120	.040	1,400 – 2,300	3,500	1	79183946	83946
				.035	1,400 – 2,300	3,500	1	79183947	83947
				.022	1,400 – 2,300	3,500	1	79183948	83948
6	1-1/2	7/8	80	.040	1,000 – 1,600	2,500	1	79183949	83949
				.045	1,000 – 1,600	2,500	1	79183970	83970
			120	.040	1,000 – 1,600	2,500	1	79183950	83950
				.035	1,000 – 1,600	2,500	1	79183951	83951
				.022	1,000 – 1,600	2,500	1	79183952	83952
8	1-1/2	7/8	80	.040	500 – 800	1,800	1	79183953	83953
				.040	500 – 800	1,800	1	79183954	83954
			180	.035	500 – 800	1,800	1	79183955	83955
				.022	500 – 800	1,800	1	79183956	83956
				320	.040	350 – 600	1,340	1	79183957
.045	350 – 600	1,340	1		79183974	83974			
.040	350 – 600	1,340	1		79183958	83958			
10	1-1/2	7/8	180	.035	350 – 600	1,340	1	79183959	83959
				.022	350 – 600	1,340	1	79183960	83960

# Composite brushes

## Composite disc brushes, crimped

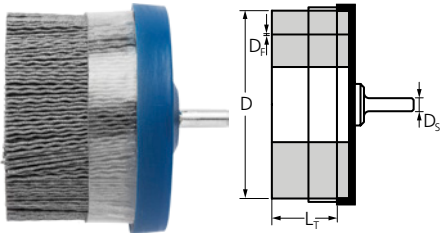

### Shank-mounted, bridled

M-BRAD® nylon abrasive filament makes this brush ideal for aggressive deburring. Developed specially for industrial use on stationary machines. The removable bridle reduces filament flare for consistently aggressive deburring action.

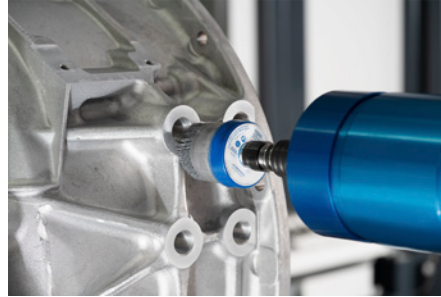

#### Special features:

- Long tool life and aggressive brushing action due to the high filament density.
- Extremely smooth operation due to evenly distributed filament material.
- If the filament has worn away down to the bridle, the bridle can be removed to extend the life of the brush. This does not affect the brushing behavior.

D [Inch]	D <sub>s</sub> [Inch]	L <sub>R</sub> [Inch]	L <sub>T</sub> [Inch]	H [Inch]	Grit size	D <sub>f</sub> [Inch]	D <sub>s</sub> [Inch]	Opt. RPM	Max. RPM		Item no.	EDP no.
<b>M-BRAD® nylon abrasive filament, silicon carbide SiC</b>												
2	1/4	3/4	1-1/2	3	80	.040	1/4	1,500 – 3,500	5,000	1	79184251	84251
						.045	1/4	1,500 – 3,500	5,000	1	79184250	84250
						.120	1/4	1,500 – 3,500	5,000	1	79184252	84252
						.180	1/4	1,500 – 3,500	5,000	1	79184253	84253
						.320	1/4	1,500 – 3,500	5,000	1	79184254	84254
2-1/2	1/4	3/4	1-1/2	3	80	.040	1/4	1,500 – 3,500	5,000	1	79184256	84256
						.045	1/4	1,500 – 3,500	5,000	1	79184255	84255
						.120	1/4	1,500 – 3,500	5,000	1	79184257	84257
						.320	1/4	1,500 – 3,500	5,000	1	79184259	84259
3	1/4	3/4	1-1/2	3	80	.040	1/4	1,500 – 3,500	5,000	1	79184261	84261
						.045	1/4	1,500 – 3,500	5,000	1	79184260	84260
						.120	1/4	1,500 – 3,500	5,000	1	79184262	84262
						.320	1/4	1,500 – 3,500	5,000	1	79184264	84264
<b>M-BRAD® nylon abrasive filament, ceramic oxide (CO)</b>												
2	1/4	3/4	1-1/2	3	80	.040	1/4	1,500 – 3,500	5,000	1	79184270	84270
						.045	1/4	1,500 – 3,500	5,000	1	79184245	84245
						.120	1/4	1,500 – 3,500	5,000	1	79184271	84271
2-1/2	1/4	3/4	1-1/2	3	80	.040	1/4	1,500 – 3,500	5,000	1	79184275	84275
3	1/4	3/4	1-1/2	3	80	.040	1/4	1,500 – 3,500	5,000	1	79184280	84280
						.120	1/4	1,500 – 3,500	5,000	1	79184281	84281
<b>Nylon plastic filament</b>												
2	1/4	-	1-1/2	3	-	.016	1/4	1,500 – 3,500	5,000	1	79184267	84267





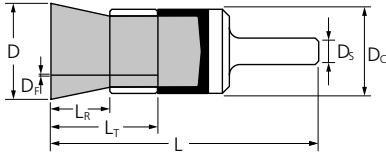

### Shank-mounted, bridled

M-BRAD® nylon abrasive filament makes this brush ideal for aggressive deburring. Developed specially for deburring and surface conditioning using stationary machines. The removable bridle reduces filament flare for consistently aggressive deburring action.



#### Special features:

- Long tool life and aggressive brushing effect due to a very high filament density. Extremely smooth operation due to even distribution of the filament material.
- Optimal access to hard-to-reach areas, such as drilled holes and crevices, as the filament spreads out upon rotation.
- If the filament has worn away down to the bridle, the bridle can be removed to extend the life of the brush. This does not affect the brushing behavior.

D [Inch]	D <sub>c</sub> [Inch]	L <sub>r</sub> [Inch]	L <sub>t</sub> [Inch]	L [Inch]	Grit size	D <sub>f</sub> [Inch]	D <sub>s</sub> [Inch]	Opt. RPM	Max. RPM		Item no.	EDP no.
<b>M-BRAD® nylon abrasive filament, ceramic oxide (CO)</b>												
1	1-1/8	9/16	1-1/8	2-3/4	80	.040	1/4	1,500 – 3,500	5,000	1	79184242	84242
						.045	1/4	1,500 – 3,500	5,000	1	79184240	84240
					120	.022	1/4	1,500 – 3,500	5,000	1	79184244	84244
						.040	1/4	1,500 – 3,500	5,000	1	79184243	84243

# Shank-mounted end brushes

## Crimped

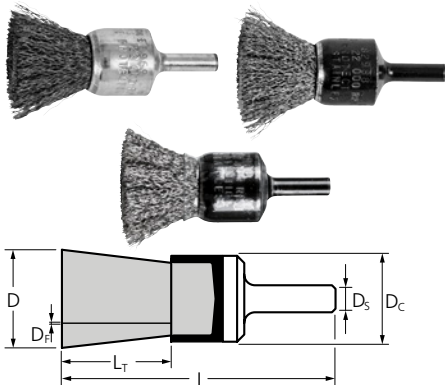

### Crimped wire

Designed for light brushing such as deburring, cleaning and derusting.



#### Special features:

- Optimal access to hard-to-reach areas such as drilled holes and cavities because the filaments spread out when rotating.
- Creates fine surfaces.

D [Inch]	D <sub>c</sub> [Inch]	D <sub>s</sub> [Inch]	L <sub>r</sub> [Inch]	D <sub>f</sub> [Inch]	L [Inch]	Opt. RPM	Max. RPM		Item no.	EDP no.
<b>Steel wire (ST)</b>										
1/2	3/4	1/4	1	.006	2-5/8	12,500 – 18,700	25,000	10	79182962	82962
				.010	2-5/8	12,500 – 18,700	25,000	10	79182964	82964
				.014	2-5/8	12,500 – 18,700	25,000	10	79182965	82965
				.020	2-5/8	12,500 – 18,700	25,000	5	79184771	82966P
								10	79182966	82966
3/4	1	1/4	1	.006	2-5/8	11,000 – 16,500	22,000	10	79182967	82967
				.010	2-5/8	11,000 – 16,500	22,000	10	79182969	82969
				.014	2-5/8	11,000 – 16,500	22,000	10	79182970	82970
				.020	2-5/8	11,000 – 16,500	22,000	5	79184777	82971P
								10	79182971	82971
1	1-1/4	1/4	1	.006	2-3/4	10,000 – 15,000	20,000	5	79184784	82972P
								10	79182972	82972
				.010	2-3/4	10,000 – 15,000	20,000	5	79152974	82974P
								10	79182974	82974
				.014	2-3/4	10,000 – 15,000	20,000	10	79182975	82975
				.020	2-3/4	10,000 – 15,000	20,000	5	79184786	82976P
								10	79182976	82976
<b>Stainless steel wire (INOX) – These INOX brushes are degreased.</b>										
1/2	3/4	1/4	1	.006	2-5/8	10,000 – 16,000	25,000	10	79182981	82981
				.010	2-5/8	10,000 – 16,000	25,000	10	79182983	82983
				.014	2-5/8	10,000 – 16,000	25,000	10	79182984	82984
				.020	2-5/8	10,000 – 16,000	25,000	10	79182985	82985
3/4	1	1/4	1	.006	2-5/8	8,500 – 14,000	22,000	5	79184778	82986P
								10	79182986	82986
				.010	2-5/8	8,500 – 14,000	22,000	10	79182988	82988
				.014	2-5/8	8,500 – 14,000	22,000	10	79182989	82989
				.020	2-5/8	8,500 – 14,000	22,000	10	79182990	82990
1	1-1/4	1/4	1	.006	2-3/4	8,000 – 13,000	20,000	5	79184787	82991P
								10	79182991	82991
				.010	2-3/4	8,000 – 13,000	20,000	5	79184788	82993P
								10	79182993	82993
				.014	2-3/4	8,000 – 13,000	20,000	10	79182994	82994
<b>Stainless steel wire (INOX) – Coated cup. These INOX brushes are degreased.</b>										
1/2	3/4	1/4	1	.006	2-5/8	10,000 – 16,000	25,000	10	79183050	83050
				.010	2-5/8	10,000 – 16,000	25,000	10	79183052	83052
3/4	1	1/4	1	.006	2-5/8	8,500 – 14,000	22,000	10	79183053	83053

Continued on next page



D [Inch]	D <sub>c</sub> [Inch]	D <sub>s</sub> [Inch]	L <sub>T</sub> [Inch]	D <sub>f</sub> [Inch]	L [Inch]	Opt. RPM	Max. RPM		Item no.	EDP no.
3/4	1	1/4	1	.010	2-5/8	8,500 – 14,000	22,000	10	79183055	83055
1	1-1/4	1/4	1	.006	2-3/4	8,000 – 13,000	20,000	10	79183056	83056
				.010	2-3/4	8,000 – 13,000	20,000	10	79183058	83058

### Circular end brushes

Excellent for light to medium-duty cleaning and deburring work on uneven surfaces.

#### Special features:

- Highly flexible, enabling optimal adjustment to the workpiece contour and less heat build-up.
- The special arrangement of the filament material means it can be used for face-side and radial brushwork at the same time.

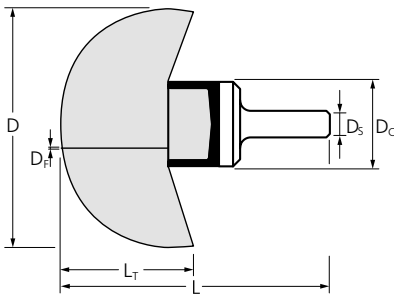
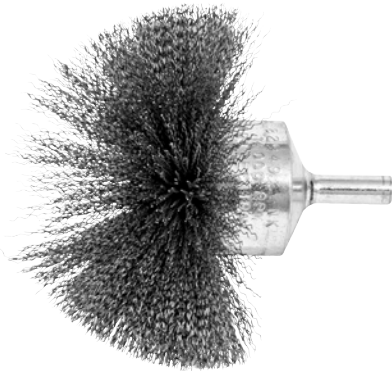

D [Inch]	D <sub>s</sub> [Inch]	D <sub>f</sub> [Inch]	L [Inch]	Opt. RPM	Max. RPM		Item no.	EDP no.
<b>Steel wire (ST)</b>								
1-1/4	1/4	.008	2-1/4	10,000 – 15,000	20,000	10	79182926	82926
1-1/2	1/4	.008	2-2/7	7,000 – 10,500	14,000	10	79182927	82927
		.020	2-2/7	7,000 – 10,500	14,000	10	79182928	82928
2	1/4	.010	2-1/2	7,000 – 10,500	14,000	10	79182929	82929
		.014	2-1/2	7,000 – 10,500	14,000	10	79182930	82930
3	1/4	.008	2-1/2	7,000 – 10,500	14,000	10	79182932	82932
		.014	2-1/2	7,000 – 10,500	14,000	10	79182933	82933
		.020	2-1/2	7,000 – 10,500	14,000	10	79182934	82934
<b>Stainless steel wire (INOX) – These INOX brushes are degreased.</b>								
1-1/2	1/4	.008	2-1/4	5,500 – 9,000	14,000	10	79182935	82935
2	1/4	.010	2-1/2	5,500 – 9,000	14,000	10	79182936	82936
3	1/4	.008	2-1/2	5,500 – 9,000	14,000	10	79182938	82938

# Shank-mounted end brushes

## Crimped



### Pilot bonding brushes

Excellent for cleaning rivet holes in the aviation sector.

#### Special features:

- The centering pin enables precise brushing.
- Tailored to the standard diameters in the aviation industry.

D [Inch]	D <sub>S</sub> [Inch]	L <sub>T</sub> [Inch]	D <sub>F</sub> [Inch]	L [Inch]	Opt. RPM	Max. RPM		Item no.	EDP no.
<b>Stainless steel wire (INOX)</b>									
1/2	1/4	1/8	.005	1-4/5	10,000 – 15,000	20,000	10	79183191	83191
				1-7/9	10,000 – 15,000	20,000	10	79183188	83188

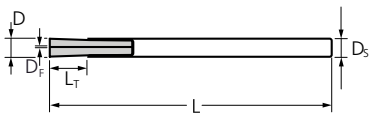

### Pencil end brushes

For cleaning blind holes and small crevices.

#### Special features:

- The metal tube can be cut back before starting work in order to achieve a large spreading diameter or to access hard-to-reach areas.

- Cutting back the metal tube exposes the rest of the filament so that all of it can be used.
- Optimal access to hard-to-reach areas.

D [Inch]	D <sub>S</sub> [Inch]	L <sub>T</sub> [Inch]	D <sub>F</sub> [Inch]	L [Inch]	Opt. RPM	Max. RPM		Item no.	EDP no.
3/16	1/4	3/8	.010	3-1/2	4,000 – 6,000	8,000	10	79182941	82941
			.012	3-1/2	3,000 – 5,000	8,000	10	79182942	82942

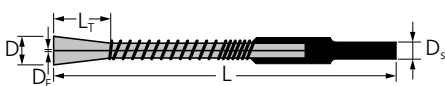

### Coil spring brushes

For cleaning deep cavities, tubing, and more.

#### Special features:

- Particularly long trim length for optimal access to hard-to-reach areas.

D [Inch]	D <sub>S</sub> [Inch]	L <sub>T</sub> [Inch]	D <sub>F</sub> [Inch]	L [Inch]	Opt. RPM	Max. RPM		Item no.	EDP no.
3/8	1/4	1	.014	6-1/4	700 – 1,000	1,800	10	79182943	82943
1/2	1/4	1	.014	6-1/4	700 – 1,000	1,800	10	79182944	82944



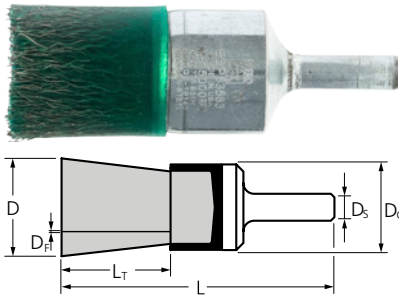

### Crimped, ECAP® encapsulated

Extremely aggressive brushing action, ideal for heavy-duty brushing.

#### Special features:

- Precise handling due to high dimensional stability.
- Maximum service life as premature wire breakage is prevented.

D [Inch]	D <sub>c</sub> [Inch]	D <sub>s</sub> [Inch]	L <sub>r</sub> [Inch]	D <sub>f</sub> [Inch]	L [Inch]	ECAP® grade	Opt. RPM	Max. RPM		Item no.	EDP no.
<b>Steel wire (ST)</b>											
1/2	5/8	1/4	7/8	.010	2-5/8	E3	9,000 – 13,500	18,000	10	79183580	83580
3/4	7/8	1/4	7/8	.010	2-5/8	E3	7,500 – 11,200	15,000	10	79183583	83583
1	1-1/8	1/4	7/8	.010	2-3/4	E4	6,500 – 10,000	13,000	10	79183596	83596

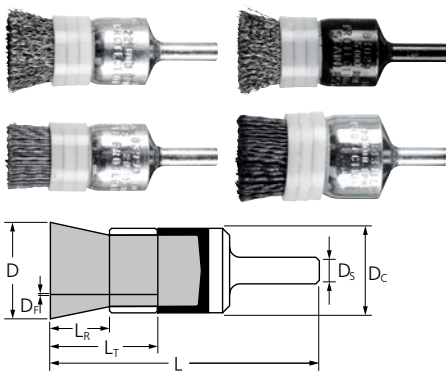

### Crimped, bridled

Designed for light brushing such as deburring, cleaning and derusting. The removable bridle reduces filament flare for consistently aggressive deburring action.



#### Special features:

- Optimal access to hard-to-reach areas such as recesses and drilled holes.
- If the filament has worn away down to the bridle, it can be removed from the bridle for further use. This does not affect the brushing behavior.
- Creates fine surfaces.

D [Inch]	D <sub>c</sub> [Inch]	D <sub>s</sub> [Inch]	L <sub>r</sub> [Inch]	L <sub>t</sub> [Inch]	L [Inch]	Grit size	D <sub>f</sub> [Inch]	Opt. RPM	Max. RPM		Item no.	EDP no.
<b>Steel wire (ST)</b>												
1/2	5/8	1/4	1/2	1	2-5/8	-	.006	7,500 – 11,200	15,000	10	79183005	83005
							.010	7,500 – 11,200	15,000	10	79183007	83007
3/4	7/8	1/4	1/2	1	2-5/8	-	.006	7,500 – 11,200	15,000	10	79183010	83010
							.010	7,500 – 11,200	15,000	10	79183012	83012
1	1-1/8	1/4	1/2	1	2-3/4	-	.006	7,500 – 11,200	15,000	10	79183015	83015
							.008	7,500 – 11,200	15,000	10	79183016	83016
							.010	7,500 – 11,200	15,000	10	79183017	83017
							.014	7,500 – 11,200	15,000	10	79183018	83018
<b>Stainless steel wire (INOX) – These INOX brushes are degreased.</b>												
1/2	5/8	1/4	1/2	1	2-5/8	-	.006	6,000 – 10,000	15,000	10	79183024	83024
							.010	6,000 – 10,000	15,000	10	79183026	83026
3/4	7/8	1/4	1/2	1	2-5/8	-	.006	6,000 – 10,000	15,000	10	79183027	83027
							.010	6,000 – 10,000	15,000	10	79183029	83029
1	1-1/8	1/4	1/2	1	2-3/4	-	.006	6,000 – 10,000	15,000	10	79183030	83030
							.010	6,000 – 10,000	15,000	10	79183032	83032

Continued on next page

# Shank-mounted end brushes

Crimped



D [Inch]	D <sub>C</sub> [Inch]	D <sub>S</sub> [Inch]	L <sub>R</sub> [Inch]	L <sub>T</sub> [Inch]	L [Inch]	Grit size	D <sub>F</sub> [Inch]	Opt. RPM	Max. RPM		Item no.	EDP no.
<b>M-BRAD® nylon abrasive filament, silicon carbide SiC</b>												
1/2	5/8	1/4	1/2	1	2-5/8	120	.040	5,200 – 9,000	20,000	10	79183996	83996
						320	.022	5,200 – 9,000	20,000	10	79183988	83988
3/4	7/8	1/4	1/2	1	2-5/8	120	.040	5,200 – 9,000	20,000	10	79184000	84000
						180	.035	5,200 – 9,000	20,000	10	79183990	83990
						320	.022	5,200 – 9,000	20,000	10	79183991	83991
1	1-1/8	1/4	1/2	1	2-3/4	120	.040	5,200 – 9,000	20,000	10	79184004	84004
						320	.022	5,200 – 9,000	20,000	10	79183994	83994
<b>M-BRAD® nylon abrasive filament, ceramic oxide (CO)</b>												
1	1-1/8	1/4	1/2	1	2-3/4	80	.040	5,200 – 9,000	20,000	10	79184310	84310
						120	.022	5,200 – 9,000	20,000	10	79184313	84313
							.040	5,200 – 9,000	20,000	10	79184311	84311

## Knotted

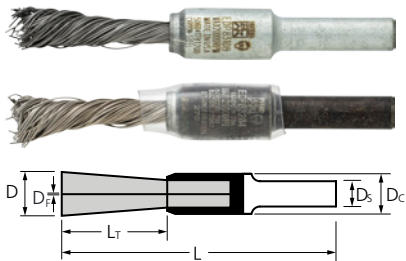

### Knot, SINGLETWIST®

Innovative and flexible single-knot brush for special applications.



#### Special features:

- Optimal access to hard-to-reach areas such as inside corners, as the knot is less likely to unravel.

D [Inch]	D <sub>C</sub> [Inch]	D <sub>S</sub> [Inch]	L <sub>T</sub> [Inch]	L [Inch]	D <sub>F</sub> [Inch]	Opt. RPM	Max. RPM		Item no.	EDP no.
<b>Steel wire (ST)</b>										
1/4	3/8	1/4	1-1/8	2-13/16	.006	2,500 – 10,000	20,000	10	79183107	83107
					.014	2,500 – 10,000	20,000	10	79183108	83108
					.020	2,500 – 10,000	20,000	10	79183109	83109
<b>Stainless steel wire (INOX) – Coated cup. These INOX brushes are degreased.</b>										
1/4	3/8	1/4	1-1/8	2-13/16	.006	2,500 – 10,000	20,000	10	79183283	83283
					.014	2,500 – 10,000	20,000	10	79183284	83284
					.020	2,500 – 10,000	20,000	10	79183285	83285



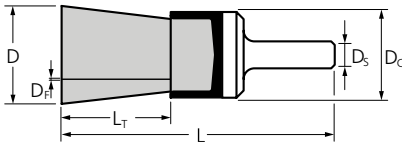

### Knotted wire

Aggressive brush. Designed for medium-duty brushing such as deburring, cleaning, derusting and descaling, as well as removing spatter.

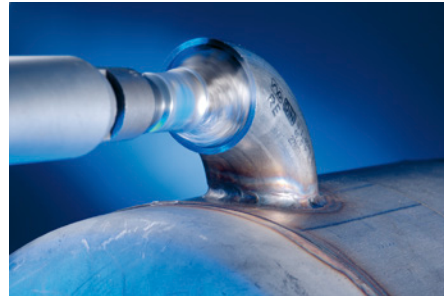

### Special features:

- Optimal access to hard-to-reach areas such as recesses and drilled holes.
- Aggressive brushing action due to tightly-twisted wire knots.

D [Inch]	Dc [Inch]	Ds [Inch]	Lr [Inch]	Df [Inch]	L [Inch]	Knots	Opt. RPM	Max. RPM		Item no.	EDP no.	
<b>Steel wire (ST)</b>												
1/2	3/4	1/4	1		.006	2-3/4	6	10,000 – 15,000	20,000	10	79183063	83063
					.010	2-3/4	6	10,000 – 15,000	20,000	10	79183064	83064
					.014	2-3/4	6	10,000 – 15,000	20,000	10	79183065	83065
3/4	7/8	1/4	1		.006	2-3/4	8	10,000 – 15,000	20,000	10	79183070	83070
					.010	2-3/4	8	10,000 – 15,000	20,000	10	79183071	83071
					.014	2-3/4	8	10,000 – 15,000	20,000	10	79183072	83072
									5	79184772	83072P	
				.020	2-3/4	8	10,000 – 15,000	20,000	10	79183073	83073	
1	1-1/8	1/4	1		.006	3	12	10,000 – 15,000	20,000	10	79183077	83078
					.010	2-3/4	12	8,000 – 12,000	15,000	10	79180187	80187
			1		.010	2-3/4	12	10,000 – 15,000	20,000	10	79183078	83078
					.014	2-3/4	12	10,000 – 15,000	20,000	10	79183079	83079
									5	79184780	83079P	
				.020	2-3/4	12	10,000 – 15,000	20,000	10	79183080	83080	
									5	79184781	83080P	
<b>Stainless steel wire (INOX) – These INOX brushes are degreased.</b>												
1/2	3/4	1/4	1		.014	2-3/4	6	8,000 – 13,000	20,000	10	79183087	83087
3/4	7/8	1/4	1		.006	2-3/4	8	8,000 – 13,000	20,000	10	79183090	83090
					.010	2-3/4	8	8,000 – 13,000	20,000	10	79183091	83091
					.014	2-3/4	8	8,000 – 13,000	20,000	10	79183092	83092
					.020	2-3/4	8	8,000 – 13,000	20,000	10	79183093	83093
1	1-1/8	1/4	1		.006	2-3/4	12	8,000 – 13,000	20,000	10	79183096	83096
					.010	2-3/4	12	8,000 – 13,000	20,000	10	79183097	83097
					.014	2-3/4	12	8,000 – 13,000	20,000	10	79183098	83098
									5	79184783	83098P	
				.020	2-3/4	12	8,000 – 13,000	20,000	10	79183099	83099	
<b>Stainless steel wire (INOX) – Coated cup. These INOX brushes are degreased.</b>												
3/4	7/8	1/4	1		.006	2-3/4	8	8,000 – 13,000	20,000	10	79183178	83178
1	1-1/8	1/4	1		.010	2-3/4	12	8,000 – 13,000	20,000	10	79183183	83183
					.014	2-3/4	12	8,000 – 13,000	20,000	10	79183184	83184
<b>Brass wire</b>												
1	1-1/8	1/4	1		.014	2-3/4	12	8,000 – 13,000	20,000	10	79183104	83104

# Shank-mounted end brushes

## Knotted

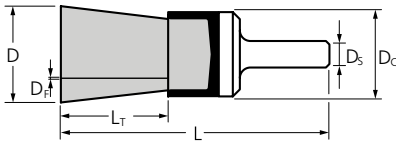

### Knot, straight cup

Aggressive brush. Designed for medium-duty brushing such as deburring, cleaning, derusting and descaling, as well as removing spatter.

#### Special features:

- Aggressive brushing action due to tightly-twisted wire knots.
- Optimal access to hard-to-reach areas such as recesses and drilled holes.
- Reduced flare for more precise surface contact.

D [Inch]	D <sub>c</sub> [Inch]	D <sub>s</sub> [Inch]	L <sub>r</sub> [Inch]	D <sub>f</sub> [Inch]	L [Inch]	Knots	Opt. RPM	Max. RPM		Item no.	EDP no.
<b>Steel wire (ST)</b>											
1/2	5/8	1/4	1-1/8	.010	2-3/4	6	10,000 – 15,000	20,000	10	79183124	83124
				.014	2-3/4	6	10,000 – 15,000	20,000	10	79183125	83125
3/4	7/8	1/4	1-1/8	.010	2-3/4	8	10,000 – 15,000	20,000	10	79183131	83131
				.014	2-3/4	8	10,000 – 15,000	20,000	10	79183132	83132
				.020	2-3/4	8	10,000 – 15,000	20,000	10	79183133	83133
1	1-1/8	1/4	1-1/8	.010	2-3/4	12	10,000 – 15,000	20,000	5	79153138	83138P
								10	79183138	83138	
				.014	2-3/4	12	10,000 – 15,000	20,000	10	79183139	83139
				.020	2-3/4	12	10,000 – 15,000	20,000	10	79183140	83140
<b>Stainless steel wire (INOX) – These INOX brushes are degreased.</b>											
1/2	5/8	1/4	1-1/8	.014	2-3/4	6	8,000 – 13,000	20,000	10	79183147	83147
3/4	7/8	1/4	1-1/8	.010	2-3/4	8	8,000 – 13,000	20,000	10	79183151	83151
				.014	2-3/4	8	8,000 – 13,000	20,000	10	79183152	83152
				.020	2-3/4	8	8,000 – 13,000	20,000	10	79183153	83153
1	1-1/8	1/4	1-1/8	.010	2-3/4	12	8,000 – 13,000	20,000	10	79183157	83157
				.014	2-3/4	12	8,000 – 13,000	20,000	10	79183158	83158
				.020	2-3/4	12	8,000 – 13,000	20,000	10	79183159	83159
<b>Brass wire</b>											
1	1-1/8	1/4	1	.014	2-3/4	12	8,000 – 13,000	20,000	10	79183164	83164





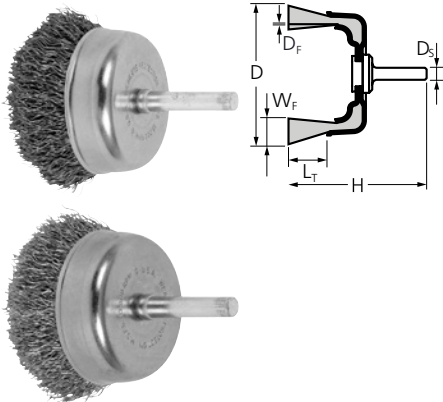

### Crimped shank mounted

Designed for cleaning, derusting and smoothing. Perfect tool for the removal of corrosion and paint. Ideal for brushing on large, flat and easily accessible surfaces with the entire brush face applied to the workpiece.



#### Special features:

- Highly flexible, enabling optimal adaptation to the workpiece contour.
- Creates fine surfaces.

D [Inch]	W <sub>F</sub> [Inch]	D <sub>S</sub> [Inch]	L <sub>T</sub> [Inch]	D <sub>F</sub> [Inch]	H [Inch]	Opt. RPM	Max. RPM		Item no.	EDP no.
<b>Steel wire (ST)</b>										
1-1/4	1-3/8	1/4	1	.014	3	6,500 – 10,000	13,000	10	79182820	82820
				.020	3	6,500 – 10,000	13,000	10	79182821	82821
1-3/4	1/2	1/4	11/16	.006	2-3/4	6,500 – 10,000	13,000	10	79182822	82822
				.012	2-3/4	6,500 – 10,000	13,000	10	79182823	82823
							5	79184818	82823P	
2	1/2	1/4	7/8	.008	2-3/4	6,500 – 10,000	13,000	10	79182824	82824
				.012	2-3/4	6,500 – 10,000	13,000	10	79182826	82826
							5	79184819	82826P	
2-1/2	3/8	1/4	7/8	.008	2-3/4	6,500 – 10,000	13,000	10	79182828	82828
				.012	2-3/4	6,500 – 10,000	13,000	10	79182830	82830
							5	79184820	82830P	
<b>Stainless steel wire (INOX)</b>										
1-3/4	1/2	1/4	11/16	.012	2-3/4	5,000 – 8,500	13,000	10	79182836	82836
2	1/2	1/4	7/8	.010	2-3/4	5,000 – 8,500	13,000	10	79182838	82838

# Shank-mounted bevel brushes

## Crimped

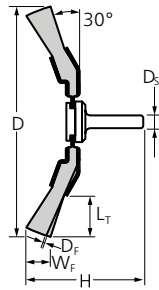

### Crimped

Excellent for medium-duty brushing such as deburring, cleaning, and derusting.



#### Special features:

- Ideal for cleaning narrow or hard-to-reach areas such as grooves, fillets, and inside edges.
- Highly flexible, enabling optimal adaptation to the workpiece contour.
- Creates fine surfaces.

D [Inch]	W <sub>F</sub> [Inch]	D <sub>S</sub> [Inch]	L <sub>T</sub> [Inch]	D <sub>F</sub> [Inch]	H [Inch]	Opt. RPM	Max. RPM		Item no.	EDP no.				
<b>Steel wire (ST)</b>														
1-1/2	1/8	1/4	5/16	.012	1-5/9	10,000 – 15,000	20,000	5	79184813	82852P				
								10	79182852	82852				
2	3/8	1/4	7/16	.008	1-2/3	10,000 – 15,000	20,000	10	79182854	82854				
								.014	1-2/3	10,000 – 15,000	20,000	5	79184814	82878P
												10	79182878	82878
.020	1-2/3	10,000 – 15,000	20,000	10	79182879	82879								
				2-1/2	3/8	1/4	11/16	.006	1-3/4	10,000 – 15,000	20,000	10	79182857	82857
												.014	1-3/4	10,000 – 15,000
3	3/8	1/4	7/8	.006	1-3/4	10,000 – 15,000	20,000	10	79182861	82861				
								.008	1-3/4	10,000 – 15,000	20,000	10	79182862	82862
												.014	1-3/4	10,000 – 15,000
10	79182863	82863												
	4	1/2	1/4	1-3/8	.008	1-3/4	10,000 – 15,000	20,000	10	79182866	82866			
.014									1-3/4	10,000 – 15,000	20,000	10	79182867	82867
	<b>Stainless steel wire (INOX)</b>													
1-1/2	1/8	1/4	5/16	.006	1-5/9	8,000 – 13,000	20,000	10	79182870	82870				
2-1/2	3/8	1/4	11/16	.014	1-3/4	8,000 – 13,000	20,000	10	79182875	82875				
3	3/8	1/4	7/8	.006	1-3/4	8,000 – 13,000	20,000	10	79182876	82876				
								.014	1-3/4	8,000 – 13,000	20,000	10	79182877	82877



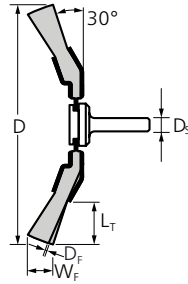

### ECAP® encapsulated

Extremely aggressive brushing action, ideal for heavy-duty brushing.

#### Special features:

- Maximum service life as premature wire breakage is prevented.
- Precise handling due to high dimensional stability.

D [Inch]	W <sub>F</sub> [Inch]	D <sub>S</sub> [Inch]	L <sub>T</sub> [Inch]	ECAP® grade	D <sub>F</sub> [Inch]	H [Inch]	Opt. RPM	Max. RPM		Item no.	EDP no.
<b>Steel wire (ST)</b>											
2	1/4	1/4	7/16	E3	.020	2-3/4	8,500 – 12,700	17,000	10	79183602	83602

# Shank-mounted wheel brushes

## Crimped

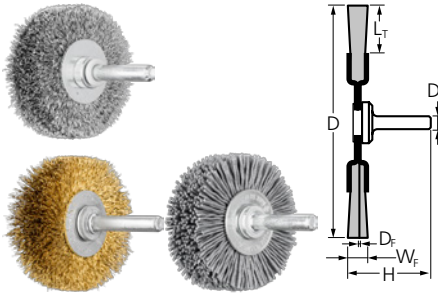

### Crimped

Designed for cleaning, derusting, smoothing, cleaning of weld seams, light deburring, and removal of corrosion and paint.



#### Special features:

- Highly flexible, enabling optimal adaptation to the workpiece contour.
- Creates fine surfaces.

D [Inch]	W <sub>F</sub> [Inch]	D <sub>S</sub> [Inch]	L <sub>T</sub> [Inch]	Grit size	D <sub>F</sub> [Inch]	H [Inch]	Opt. RPM	Max. RPM		Item no.	EDP no.			
<b>Steel wire (ST)</b>														
1-1/2	1/4	1/4	7/16	-	.006	1-1/4	10,000 – 15,000	20,000	10	79182890	82890			
					.012	1-1/4	10,000 – 15,000	20,000	10	79182892	82892			
					.020	1-1/4	10,000 – 15,000	20,000	10	79182889	82889			
2	3/8	1/4	1/2	-	.008	1-3/8	10,000 – 15,000	20,000	10	79182893	82893			
					.012	1-3/8	10,000 – 15,000	20,000	10	79182894	82894			
	5/8	1/4	1/2	-	.008	1-8/9	8,000 – 11,000	15,000	10	79182902	82902			
2-1/2	1/2	1/4	3/4	-	.014	1-1/3	10,000 – 15,000	20,000	10	79182896	82896			
3	5/8	1/4	3/4	-	.012	1-6/7	6,000 – 9,000	12,000	10	79182903	82903			
						1	-	.006	1-3/8	8,000 – 11,000	15,000	10	79182897	82897
							-	.008	1-3/8	8,000 – 11,000	15,000	10	79182898	82898
							-	.012	1-3/8	8,000 – 11,000	15,000	10	79182899	82899
							-	.014	1-3/8	8,000 – 11,000	15,000	10	79182900	82900
		-	.020	1-3/8	8,000 – 11,000	15,000	10	79182901	82901					
<b>Stainless steel wire (INOX)</b>														
1-1/2	1/4	1/4	7/16	-	.006	1-1/4	8,000 – 13,000	20,000	10	79182905	82905			
					.012	1-1/4	8,000 – 13,000	20,000	10	79182906	82906			
2	3/8	1/4	1/2	-	.008	1-3/8	8,000 – 13,000	20,000	10	79182907	82907			
					.012	1-3/8	8,000 – 13,000	20,000	10	79182908	82908			
	5/8	1/4	1/2	-	.008	1-8/9	8,000 – 13,000	20,000	10	79182951	82951			
2-1/2	1/2	1/4	3/4	-	.008	1-1/3	8,000 – 13,000	20,000	10	79182909	82909			
					.012	1-1/3	8,000 – 13,000	20,000	10	79182910	82910			
3	5/8	1/4	3/4	-	.012	1-6/7	6,000 – 9,000	12,000	10	79182952	82952			
						1	-	.006	1-3/8	6,000 – 9,000	12,000	10	79182911	82911
							-	.008	1-3/8	6,000 – 9,000	12,000	10	79182912	82912
		-	.014	1-3/8	6,000 – 9,000	12,000	10	79182913	82913					
<b>Brass wire</b>														
2	5/8	1/4	1/2	-	.008	1-6/7	8,000 – 11,000	15,000	10	79182953	82953			
3	5/8	1/4	3/4	-	.012	1-6/7	6,000 – 9,000	12,000	10	79182954	82954			
			1	-	.014	1-2/5	6,000 – 9,000	12,000	10	79182914	82914			
<b>M-BRAD® nylon abrasive filament, ceramic oxide (CO)</b>														
2	1/4	1/4	1/2	120	.022	1-1/2	6,000 – 9,800	15,000	10	79184203	84203			
					.040	2	6,000 – 9,800	15,000	10	79184202	84202			
	5/8	1/4	1/2	80	.022	2	6,000 – 9,800	15,000	10	79184200	84200			
					.040	2	6,000 – 9,800	15,000	10	79184201	84201			
3	1/4	1/4	3/4	80	.040	1-4/5	4,800 – 7,800	12,000	10	79184208	84208			

Continued on next page

D [Inch]	W <sub>F</sub> [Inch]	D <sub>S</sub> [Inch]	L <sub>T</sub> [Inch]	Grit size	D <sub>F</sub> [Inch]	H [Inch]	Opt. RPM	Max. RPM		Item no.	EDP no.
3	5/8	1/4	3/4	80	.040	2	4,800 – 7,800	12,000	10	79184207	84207
				120	.022	2	4,800 – 7,800	12,000	10	79184205	84205
					.040	2	4,800 – 7,800	12,000	10	79184206	84206

## Knotted

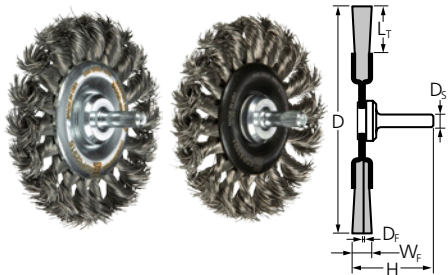

### Knot wire, full cable twist

Aggressive brush for cleaning, derusting and work on weld seams.



#### Special features:

- Optimal access to hard-to-reach areas such as grooves and recesses.
- Aggressive brushing action due to tightly-twisted wire knots.

D [Inch]	W <sub>F</sub> [Inch]	D <sub>S</sub> [Inch]	L <sub>T</sub> [Inch]	D <sub>F</sub> [Inch]	H [Inch]	Knots	Opt. RPM	Max. RPM		Item no.	EDP no.
<b>Steel wire (ST)</b>											
3	7/16	1/4	3/4	.012	1-1/4	18	12,500 – 18,700	25,000	10	79182915	82915
				.014	1-1/4	18	12,500 – 18,700	25,000	10	79182916	82916
				.020	1-1/4	18	12,500 – 18,700	25,000	10	79182917	82917
3-1/4	1/2	1/4	3/4	.014	1-1/4	20	12,500 – 18,700	25,000	10	79182946	82946
				.020	1-1/4	20	12,500 – 18,700	25,000	10	79182947	82947
4	5/8	1/4	3/4	.014	1-1/4	22	12,500 – 18,700	25,000	10	79182919	82919
				.020	1-1/4	22	12,500 – 18,700	25,000	10	79182920	82920
<b>Stainless steel wire (INOX)</b>											
3	7/16	1/4	3/4	.014	1-1/4	18	10,000 – 16,000	25,000	10	79182921	82921
3-1/4	1/2	1/4	3/4	.014	1-1/4	20	10,000 – 16,000	25,000	10	79182948	82948
4	5/8	1/4	3/4	.014	1-1/4	22	10,000 – 16,000	25,000	10	79182922	82922

# Drum brushes

## Crimped

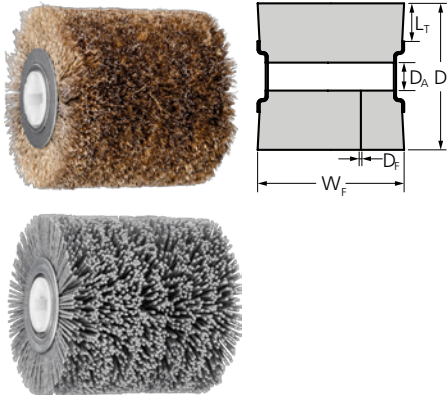

### Drum brushes

Excellent for surface structuring work on large workpieces.



#### Special features:

- Can be used on all common burnishing machines due to keyed arbor hole.
- Creates fine surfaces.

D [Inch]	W <sub>F</sub> [Inch]	L <sub>T</sub> [Inch]	D <sub>A</sub> [Inch]	D <sub>F</sub> [Inch]	Opt. RPM	Max. RPM		Item no.	EDP no.
<b>Steel wire, brass plated</b>									
4	4	1	3/4	.050	3,000 – 4,500	6,000	1	43509001	81330
<b>Stainless steel wire (INOX)</b>									
4	4	1	3/4	.008	2,400 – 3,900	6,000	1	43509003	81331



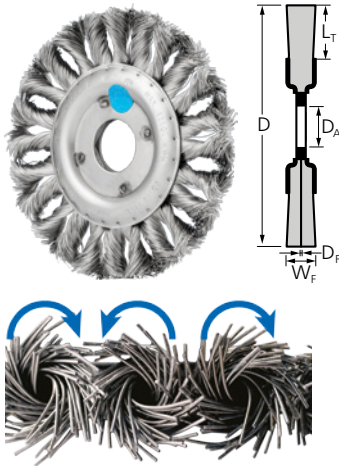

**COMBITWIST® knot**

Very aggressive brush for heavy-duty brushing. Specially developed for work on stainless steel (INOX). Designed for work on corners and edges as the knots are less likely to unravel.



**Special features:**

- Maximum protection against corrosion as all components are produced from stainless steel (INOX) of quality 1.4310 (V2A). Particularly well-suited to use in extremely critical environments.
- Maximum economic efficiency due to maximum tool life and stock removal rate and high level of comfort thanks to smooth running with no brush recoiling.
- Aggressive brushing action due to tightly-twisted wire knots.

D [Inch]	W <sub>F</sub> [Inch]	L <sub>T</sub> [Inch]	D <sub>A</sub> [Inch]	D <sub>F</sub> [Inch]	Knots	Opt. RPM	Max. RPM		Item no.	EDP no.
<b>Stainless steel wire (INOX)</b> – These INOX brushes are degreased.										
4-1/2	1/2	7/8	7/8	.014	24	5,000 – 12,500	12,500	1	43300042	82741

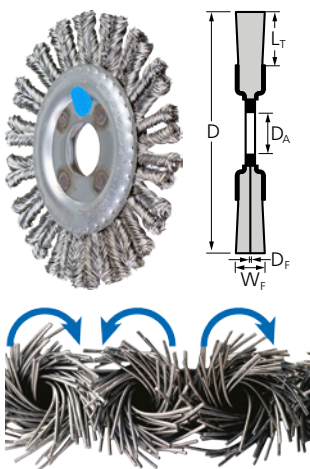

**Pipeline, COMBITWIST®**

Brush that has been specially developed for work on stainless steel (INOX). Perfect for heavy-duty brushing in pipeline and container construction. Designed for work on corners and edges as the knots are less likely to unravel.

**Special features:**

- Maximum protection against corrosion as all components are produced from stainless steel (INOX) of quality 1.4310 (V2A). Particularly well-suited to use in extremely critical environments.
- Extra-slim design allows access to hard-to-reach areas such as root weld seams.
- Maximum economic efficiency due to maximum tool life and stock removal rate and high level of comfort thanks to smooth running with no brush recoiling.

D [Inch]	W <sub>F</sub> [Inch]	L <sub>T</sub> [Inch]	D <sub>A</sub> [Inch]	D <sub>F</sub> [Inch]	Knots	Opt. RPM	Max. RPM		Item no.	EDP no.
<b>Stainless steel wire (INOX)</b> – These INOX brushes are degreased.										
4-1/2	3/16	7/8	7/8	.014	36	5,000 – 12,500	12,500	1	43300032	82742

# INOX-TOTAL

## Shank-mounted wheel brushes

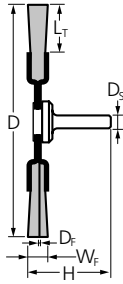
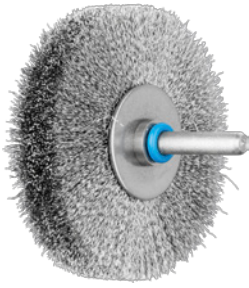

### Crimped

Designed for cleaning, deburring and removal of heat discoloration. Specially developed for work on stainless steel (INOX).



#### Special features:

- Maximum protection against corrosion as all components are produced from stainless steel (INOX) of quality 1.4310 (V2A). Particularly well-suited to use in extremely critical environments.
- Highly flexible, enabling optimal adaptation to the workpiece contour.
- Creates fine surfaces.

D [Inch]	W <sub>F</sub> [Inch]	D <sub>S</sub> [Inch]	L <sub>T</sub> [Inch]	D <sub>F</sub> [Inch]	H [Inch]	Opt. RPM	Max. RPM		Item no.	EDP no.
<b>Stainless steel wire (INOX)</b> – These INOX brushes are degreased.										
2	5/8	1/4	3/4	.008	2	6,000 – 9,000	12,000	10	79182744	82744

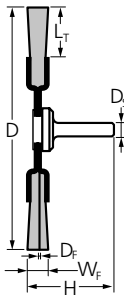
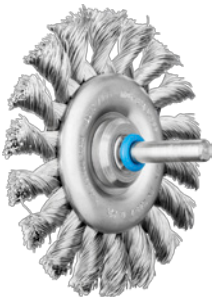

### Knot, standard twist

Designed for cleaning, deburring and removal of heat discoloration. Specially developed for work on stainless steel (INOX).

#### Special features:

- Maximum protection against corrosion as all components are produced from stainless steel (INOX) of quality 1.4310 (V2A). Particularly well-suited to use in extremely critical environments.

- Aggressive brushing action due to tightly-twisted wire knots.

D [Inch]	W <sub>F</sub> [Inch]	D <sub>S</sub> [Inch]	L <sub>T</sub> [Inch]	D <sub>F</sub> [Inch]	Knots	H [Inch]	Opt. RPM	Max. RPM		Item no.	EDP no.
<b>Stainless steel wire (INOX)</b> – These INOX brushes are degreased.											
3	1/4	1/4	3/4	.014	18	1-21/32	10,000 – 16,300	25,000	10	43100252	82743





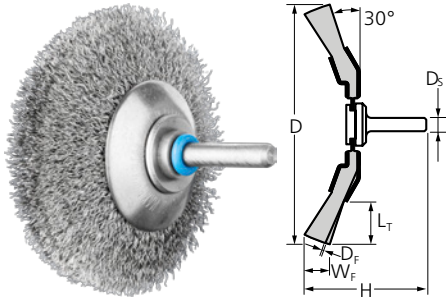

**Crimped**

Excellent for medium-duty brushing such as deburring, cleaning, and removal of heat discoloration. Specially developed for work on stainless steel (INOX).



**Special features:**

- Maximum protection against corrosion as all components are produced from stainless steel (INOX) of quality 1.4310 (V2A). Particularly well-suited to use in extremely critical environments.
- Ideal for cleaning narrow or hard-to-reach areas such as grooves, fillets, and inside edges.
- Highly flexible, enabling optimal adjustment to the workpiece contour. Creates fine surfaces.

D [Inch]	W <sub>F</sub> [Inch]	D <sub>S</sub> [Inch]	L <sub>T</sub> [Inch]	D <sub>F</sub> [Inch]	H [Inch]	Opt. RPM	Max. RPM		Item no.	EDP no.
<b>Stainless steel wire (INOX)</b> – These INOX brushes are degreased.										
2-3/4	3/8	1/4	5/8	.008	5/8	6,000 – 9,000	12,000	10	79182745	82745

# Miniature brushes

## End brushes, crimped

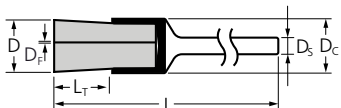

### Crimped wire

Designed for light brushing such as deburring, cleaning and polishing. Miniature brushes can be used on flexible shaft drives, micro motors or electric grinders.



#### Special features:

- Maximum precision and efficiency on delicate workpieces.
- Optimal access to hard-to-reach areas, such as drilled holes and crevices, as the filament spreads out upon rotation.
- Creates fine surfaces.

D [Inch]	D <sub>c</sub> [Inch]	D <sub>s</sub> [Inch]	L <sub>r</sub> [Inch]	Grit size	D <sub>f</sub> [Inch]	L [Inch]	Opt. RPM	Max. RPM		Item no.	EDP no.
<b>Steel wire (ST)</b>											
1/4	1/4	1/8	7/16	-	.005	1-3/4	5,000 – 15,000	25,000	36	79183257	83257
5/16	5/16	1/8	1/2	-	.005	1-3/4	5,000 – 15,000	25,000	36	79183258	83258
<b>Stainless steel wire (INOX)</b>											
1/4	1/4	1/8	7/16	-	.005	1-3/4	4,500 – 12,500	25,000	36	79183262	83262
5/16	5/16	1/8	1/2	-	.005	1-3/4	4,500 – 12,500	25,000	36	79183263	83263
<b>Brass wire</b>											
1/4	1/4	1/8	7/16	-	.005	1-3/4	3,000 – 10,000	25,000	36	79183267	83267
<b>M-BRAD® nylon abrasive filament, aluminum oxide A</b>											
3/16	1/4	1/8	5/16	600	.012	1-3/4	1,200 – 5,000	6,000	36	79183270	83270
<b>Natural bristles, black Tampico</b>											
1/4	1/4	1/8	7/16	-	-	1-3/4	5,000 – 10,000	25,000	36	79183279	83279



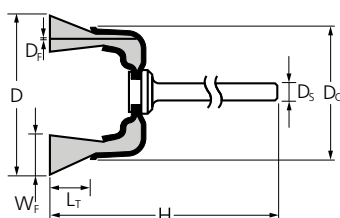

### Crimped shank mounted

Ideal for brushing uneven surfaces. Used for light to medium duty brushing action such as removal of light scale, dirt, rust, corrosion, and light burrs. These brushes can be used on flexible shaft drives, micro motors or electric grinders.

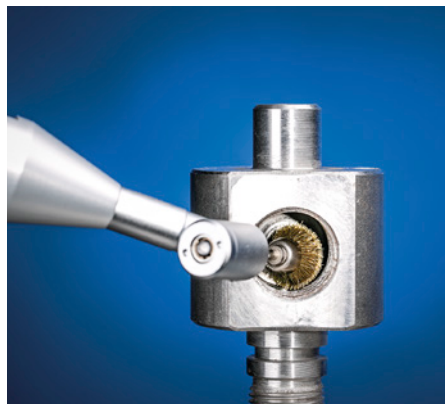

#### Special features:

- Maximum precision and efficiency on delicate workpieces.
- Highly flexible, enabling optimal adaptation to the workpiece contour.
- Creates fine surfaces.

D [Inch]	D <sub>c</sub> [Inch]	D <sub>s</sub> [Inch]	W <sub>f</sub> [Inch]	L <sub>r</sub> [Inch]	Grit size	D <sub>f</sub> [Inch]	H [Inch]	Opt. RPM	Max. RPM		Item no.	EDP no.
<b>Steel wire (ST)</b>												
9/16	3/8	1/8	1/8	1/4	-	.005	1-3/4	5,000 – 15,000	25,000	36	79183236	83236
<b>Stainless steel wire (INOX)</b>												
9/16	3/8	1/8	1/8	1/4	-	.005	1-3/4	4,500 – 12,500	25,000	36	79183240	83240
<b>M-BRAD® nylon abrasive filament, aluminum oxide A</b>												
9/16	3/8	1/8	1/8	1/4	600	.012	1-3/4	1,200 – 4,000	6,000	36	79183247	83247
<b>Natural bristles, black Tampico</b>												
9/16	3/8	1/8	1/8	1/4	-	-	1-3/4	5,000 – 10,000	25,000	36	79183250	83250
<b>Natural bristles</b>												
9/16	3/8	1/8	1/8	1/4	-	-	1-3/4	5,000 – 10,000	25,000	36	79183252	83252

# Miniature brushes

## Wheel brushes, crimped

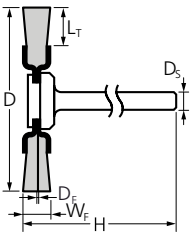

### Crimped

Designed for light brushing such as deburring, cleaning and polishing. Miniature brushes can be used on flexible shaft drives, micro motors or electric grinders.



#### Special features:

- Maximum precision and efficiency on delicate workpieces.
- Precise handling in hard-to-reach areas.
- Creates fine surfaces.

D [Inch]	W <sub>F</sub> [Inch]	D <sub>S</sub> [Inch]	L <sub>T</sub> [Inch]	Grit size	D <sub>F</sub> [Inch]	H [Inch]	Opt. RPM	Max. RPM		Item no.	EDP no.
<b>Steel wire (ST)</b>											
3/4	1/16	1/8	3/16	-	.005	1-13/16	5,000 – 15,000	25,000	36	79183202	83202
1	1/16	1/8	1/4	-	.005	1-13/16	5,000 – 15,000	25,000	36	79183204	83204
1-1/2	1/16	1/8	1/2	-	.005	1-13/16	5,000 – 15,000	25,000	36	79183206	83206
<b>Stainless steel wire (INOX)</b>											
3/4	1/16	1/8	3/16	-	.005	1-13/16	4,500 – 12,500	25,000	36	79183210	83210
1	1/16	1/8	1/4	-	.005	1-13/16	4,500 – 12,500	25,000	36	79183212	83212
1-1/2	1/16	1/8	1/2	-	.005	1-13/16	4,500 – 12,500	25,000	36	79183213	83213
<b>Brass wire</b>											
1	1/16	1/8	1/4	-	.005	1-13/16	3,000 – 10,000	25,000	36	79183218	83218
<b>M-BRAD® nylon abrasive filament, aluminum oxide A</b>											
3/4	1/16	1/8	3/16	600	.012	1-13/16	1,200 – 4,000	6,000	36	79183221	83221
1	1/16	1/8	1/4	600	.012	1-13/16	1,200 – 4,000	6,000	36	79183223	83223
<b>Natural bristles, black Tampico</b>											
3/4	1/16	1/8	3/16	-	-	1-13/16	5,000 – 10,000	25,000	36	79183231	83231





### Miniature Brush Set – 15 Pieces

PFERD shank-mounted miniature brushes are ideal for precision applications in a variety of industries including jewellery, electronics, medical and aerospace. All brushes are suitable for use with a flexible shaft drive, straight grinders and a micro motor system.

**Special features:**

- Selection of the most common versions.
- All brushes have a 1/8" shank.
- Maximum precision and efficiency when working on delicate workpieces.

	Item no.	EDP no.
1	79182955	82955

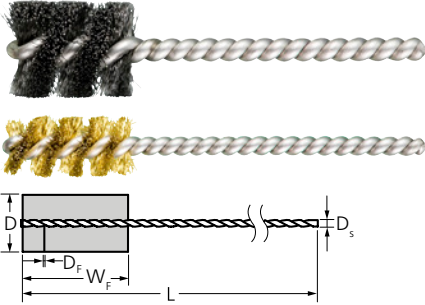

### Single stem, single spiral

For light cleaning and deburring work on threaded holes or recesses, e.g. keyways.

#### Special features:

- Highly flexible, enabling optimal adjustment to the workpiece contour. Longer service life due to the design of the stem.
- In tube brushes with a short eyelet, the filament reaches up to the tip of the brush.
- The bent end of the wire does not have any sharp edges, which prevents delicate surfaces from getting scratched.

D [Inch]	W <sub>F</sub> [Inch]	D <sub>S</sub> [Inch]	D <sub>F</sub> [Inch]	L [Inch]	Max. RPM		Item no.	EDP no.
<b>Steel wire (ST)</b>								
1/4	1	1/8	.005	3-1/2	2,500	36	79183351	83351
5/16	1	1/8	.005	3-1/2	2,500	36	79183352	83352
3/8	1	5/32	.005	3-1/2	2,500	36	79183354	83354
			.008	3-1/2	2,500	36	79183356	83356
1/2	1	5/32	.005	3-1/2	2,500	36	79183358	83358
9/16	1	5/32	.005	3-1/2	2,500	36	79183359	83359
5/8	1	5/32	.005	3-1/2	2,500	36	79183360	83360
			.008	3-1/2	2,500	36	79183361	83361
3/4	1	1/4	.005	3-1/2	2,500	36	79183363	83363
13/16	1	1/4	.005	3-1/2	2,500	36	79183366	83366
7/8	1	1/4	.005	3-1/2	2,500	36	79183367	83367
1	1	1/4	.005	3-1/2	2,500	36	79183371	83371
			.008	3-1/2	2,500	36	79183372	83372
1-1/8	1	1/4	.005	3-1/2	2,500	36	79183373	83373
			.008	3-1/2	2,500	36	79183374	83374
1-1/4	1	1/4	.005	3-1/2	2,500	36	79183375	83375
			.008	3-1/2	2,500	36	79183376	83376
1-1/2	1	1/4	.008	3-1/2	2,500	36	79183377	83377
2-1/4	1	1/4	.008	3-1/2	2,500	36	79183379	83379
<b>Stainless steel wire (INOX)</b>								
1/4	1	1/8	.005	3-1/2	2,500	36	79183387	83387
3/8	1	5/32	.005	3-1/2	2,500	36	79183389	83389
7/16	1	1/8	.005	3-1/2	2,500	36	79183391	83391
1/2	1	5/32	.005	3-1/2	2,500	36	79183392	83392
9/16	1	5/32	.005	3-1/2	2,500	36	79183393	83393
5/8	1	5/32	.005	3-1/2	2,500	36	79183395	83395
11/16	1	5/32	.005	3-1/2	2,500	36	79183396	83396
3/4	1	1/4	.005	3-1/2	2,500	36	79183397	83397
13/16	1	1/4	.005	3-1/2	2,500	36	79183399	83399
7/8	1	1/4	.005	3-1/2	2,500	36	79183400	83400
			.008	3-1/2	2,500	36	79183402	83402
1	1	1/4	.005	3-1/2	2,500	36	79183402	83402
			.008	3-1/2	2,500	36	79183403	83403
1-1/4	1	1/4	.005	3-1/2	2,500	36	79183406	83406
			.008	3-1/2	2,500	36	79183407	83407
<b>Brass wire</b>								
1/4	1	1/8	.005	3-1/2	2,500	36	79183411	83411
3/8	1	5/32	.005	3-1/2	2,500	36	79183412	83412
1/2	1	5/32	.005	3-1/2	2,500	36	79183413	83413
1	1	1/4	.008	3-1/2	2,500	36	79183417	83417

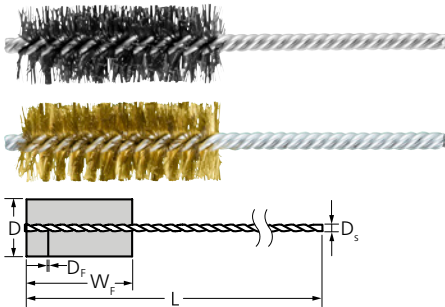

### Double stem, double spiral

The high-performance tube brush is highly designed for deburring cross holes and for cleaning threads.

#### Special features:

- Long tool life due to high filament density and double spirals.

D [Inch]	W <sub>F</sub> [Inch]	D <sub>S</sub> [Inch]	D <sub>F</sub> [Inch]	L [Inch]	Max. RPM		Item no.	EDP no.
<b>Steel wire (ST)</b>								
1/4	2	5/32	.006	6	2,500	10	79183420	83420
3/8	2	5/32	.006	6	2,500	10	79183422	83422
1/2	2	5/32	.004	6	2,500	10	79183423	83423
			.006	6	2,500	10	79183424	83424
			.010	6	2,500	10	79183425	83425
5/8	2	5/32	.008	6	2,500	10	79183427	83427
			.010	6	2,500	10	79183428	83428
3/4	2-1/2	1/4	.006	5-1/2	2,500	10	79183430	83430
			.010	5-1/2	2,500	10	79183432	83432
7/8	2-1/2	1/4	.006	5-1/2	2,500	10	79183434	83434
			.010	5-1/2	2,500	10	79183435	83435
1	2-1/2	1/4	.006	5-1/2	2,500	10	79183436	83436
			.010	5-1/2	2,500	10	79183437	83437
1-1/4	2-1/2	1/4	.006	5-1/2	2,500	10	79183438	83438
			.010	5-1/2	2,500	10	79183439	83439
<b>Stainless steel wire (INOX)</b>								
1/2	2	5/32	.004	6	2,500	10	79183440	83440
			.006	6	2,500	10	79183441	83441
5/8	2	5/32	.008	6	2,500	10	79183443	83443
3/4	2-1/2	1/4	.006	5-1/2	2,500	10	79183445	83445
			.010	5-1/2	2,500	10	79183446	83446
7/8	2-1/2	1/4	.006	5-1/2	2,500	10	79183447	83447
			.010	5-1/2	2,500	10	79183448	83448
1	2-1/2	1/4	.006	5-1/2	2,500	10	79183449	83449
			.010	5-1/2	2,500	10	79183450	83450
<b>Brass wire</b>								
5/8	2	5/32	.008	6	2,500	10	79183460	83460
3/4	2-1/2	1/4	.006	5-1/2	2,500	10	79183461	83461
7/8	2-1/2	1/4	.006	5-1/2	2,500	10	79183462	83462
1	2-1/2	1/4	.006	5-1/2	2,500	10	79183463	83463

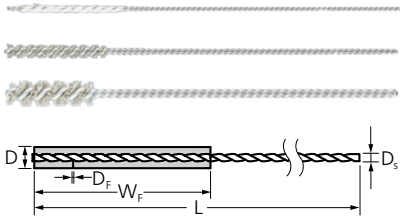

### Microabrasive tube brushes

For light deburring and cleaning of holes and cross holes and for work on surfaces. With tube brushes with a short eyelet, the filament reaches up to the tip of the brush.

#### Special features:

- Highly flexible, enabling optimal adjustment to the workpiece contour. Creates fine surfaces.
- Enable maximum precision and efficiency in work on delicate workpieces. The dimensional accuracy of the workpieces remains unchanged.
- The bent end of the wire does not have any sharp edges, which prevents delicate surfaces from getting scratched.

D [Inch]	W <sub>F</sub> [Inch]	D <sub>S</sub> [Inch]	D <sub>F</sub> [Inch]	L [Inch]	Grit size	Max. RPM		Item no.	EDP no.
<b>M-BRAD® nylon abrasive filament, aluminum silicate, 2,000 grit</b>									
0.03	1/2	0.015	.006	4	2000	1,000	10	79184071	84071
0.05	1/2	0.022	.006	4	2000	1,000	10	79184072	84072
0.075	3/4	0.033	.006	4	2000	1,000	10	79184073	84073
0.09	3/4	0.041	.006	4	2000	1,000	10	79184074	84074
0.105	1	0.041	.006	4	2000	1,000	10	79184075	84075
0.125	1	0.064	.006	4	2000	1,000	10	79184076	84076
0.135	1	0.075	.006	4	2000	1,000	10	79184077	84077
<b>M-BRAD® nylon abrasive filament, aluminum oxide, 600 grit</b>									
0.165	1	0.087	.006	5	600	1,000	10	79184078	84078
0.19	1	0.087	.006	5	600	1,000	10	79184079	84079
0.26	1	0.115	.006	5	600	1,000	10	79184080	84080
0.325	1	0.115	.006	5	600	1,000	10	79184081	84081
0.385	1	0.147	.006	5	600	1,000	10	79184082	84082
0.515	1	0.168	.006	5	600	1,000	10	79184083	84083
0.64	1	0.168	.006	5	600	1,000	10	79184084	84084

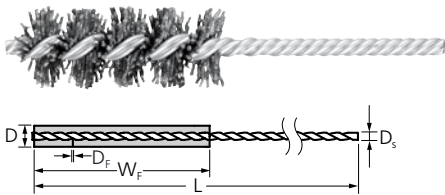

### Double stem, single spiral

High-performance tube brush for deburring and cleaning threads, holes and cross holes.

#### Special features:

- Highly flexible, enabling optimal adjustment to the workpiece contour and less heat build-up.
- The dimensional accuracy of the workpieces remains unchanged.

D [Inch]	W <sub>F</sub> [Inch]	D <sub>S</sub> [Inch]	D <sub>F</sub> [Inch]	L [Inch]	Grit size	Max. RPM		Item no.	EDP no.
<b>M-BRAD® nylon abrasive filament, silicon carbide SiC</b>									
1/4	2	5/32	.022	5	320	1,500	10	79184011	84011
5/16	2	5/32	.022	5	320	1,500	10	79184012	84012
3/8	2	5/32	.022	5	320	1,500	10	79184013	84013
7/16	2	5/32	.022	5	320	1,500	10	79184014	84014
1/2	2	3/16	.022	5	320	1,500	10	79184018	84018
5/8	2	7/32	.022	5	320	1,500	10	79184022	84022
3/4	2-1/2	1/4	.022	5-1/2	320	1,500	10	79184027	84027
				5-1/2	120	1,500	10	79184025	84025
					80	1,500	10	79184024	84024
1	2-1/2	1/4	.022	5-1/2	320	1,500	10	79184043	84043
				5-1/2	120	1,500	10	79184041	84041
				5-1/2	80	1,500	10	79184040	84040
1-1/4	2-1/2	1/4	.040	5-1/2	120	1,500	10	79184050	84050

Continued on next page



D [Inch]	W <sub>F</sub> [Inch]	D <sub>S</sub> [Inch]	D <sub>F</sub> [Inch]	L [Inch]	Grit size	Max. RPM		Item no.	EDP no.
1-1/2	2-1/2	1/4	.022	5-1/2	320	1,500	10	79184057	84057
			.040	5-1/2	120	1,500	10	79184055	84055
1-3/4	2-1/2	1/4	.022	5-1/2	320	1,500	10	79184062	84062
			.040	5-1/2	120	1,500	10	79184060	84060
2	2-1/2	1/4	.022	5-1/2	320	1,500	10	79184066	84066

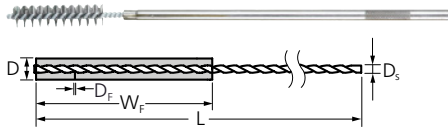

### Valve guide brushes

Brush for brushing valve guides. High brush stiffness for aggressive cleaning.

#### Special features:

- The metal sleeve construction enables stable operation without bending.
- Includes knurled handle for manual use.

D [Inch]	W <sub>F</sub> [Inch]	D <sub>S</sub> [Inch]	D <sub>F</sub> [Inch]	L [Inch]	Max. RPM		Item no.	EDP no.
<b>Steel wire (ST)</b>								
1/4	2	1/4	.006	10	2,500	10	79183465	83465
5/16	2	1/4	.006	10	2,500	10	79183466	83466
11/32	2	1/4	.006	10	2,500	10	79183467	83467
3/8	2	1/4	.006	10	2,500	10	79183468	83468
7/16	2	1/4	.006	10	2,500	10	79183469	83469
1/2	2	1/4	.006	10	2,500	10	79183470	83470

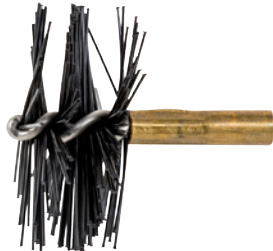



### Threaded tube brushes for flexible shafts

Designed for working inside pipes, pipelines and pipe bends.

#### Special features:

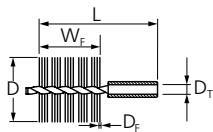
- Low risk of workpiece contamination, as exclusively iron-free components are used. Ideal for use in the pharmaceutical and food industry.



D [Inch]	W <sub>F</sub> [Inch]	D <sub>T</sub>	D <sub>F</sub> [Inch]	L [Inch]	For pipe I.D. [Inch]	Max. RPM		Item no.	EDP no.
<b>Nylon plastic filament</b>									
1-1/4	1/2	8-32	.018	1-5/16	1	2,500	10	79184432	84432
1-3/4	1/2	8-32	.018	1-5/16	1 1/2	2,500	10	79184434	84434
2-1/4	1/2	8-32	.018	1-5/16	2	2,500	10	79184436	84436
2-3/4	1/2	8-32	.018	1-5/16	2 1/2	2,500	10	79184438	84438

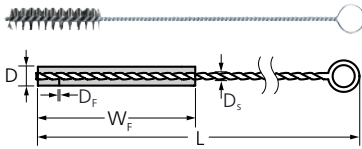

### Loop handle power tube brushes

For light cleaning and deburring work on threaded holes or recesses, such as keyways. Excellent for manual use.



#### Special features:

- Maximum precision and efficiency when working on delicate workpieces.
- Optimal access to hard-to-reach areas such as the inner surfaces of pipes and drilled holes.
- Creates fine surfaces.

D [Inch]	W <sub>F</sub> [Inch]	L [Inch]	D <sub>F</sub> [Inch]	D <sub>S</sub> [Inch]		Item no.	EDP no.
<b>Steel wire (ST)</b>							
1/4	1-1/2	7	.006	0.118	12	79189564	89564
3/8	2	8	.006	0.118	12	79189565	89565
1/2	2	8	.006	0.17	12	79189566	89566
<b>Stainless steel wire (INOX)</b>							
3/16	1-1/2	7	.006	0.09	12	79189568	89568
1/4	1-1/2	8	.006	0.118	12	79189569	89569
3/8	2	8	.006	0.118	12	79189570	89570
1/2	2	8	.006	0.17	12	79189571	89571

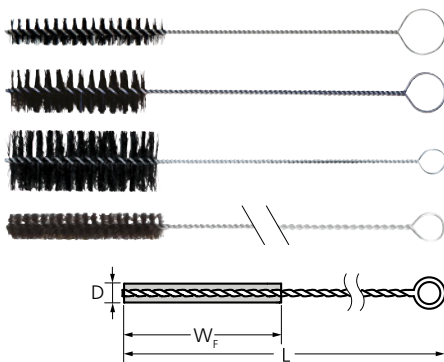

### Loop handle hand tube brushes

Designed for manual use.

#### Special features:

- Maximum precision and efficiency when working on delicate workpieces.
- Optimal access to hard-to-reach areas such as the inner surfaces of pipes and drilled holes.

D [Inch]	W <sub>F</sub> [Inch]	L [Inch]		Item no.	EDP no.
<b>Nylon plastic filament</b>					
1/4	2	6-1/8	12	79189578	89578
1/2	3	8-1/2	12	79189580	89580
3/4	3	8-1/2	12	79189581	89581
1	4	12	12	79189582	89582
1-1/4	4	13	12	79189583	89583
2	5	15	12	79189585	89585
<b>Black horsehair</b>					
5/8	4-1/2	42	1	79189594	89594
3/4	4-1/2	42	1	79189595	89595
1	4	12	12	79189576	89576

Continued on next page

D [Inch]	W <sub>F</sub> [Inch]	L [Inch]		Item no.	EDP no.
1-1/4	4-1/2	40-1/2	1	79189597	89597
2-1/4	7	30	1	79189437	89437

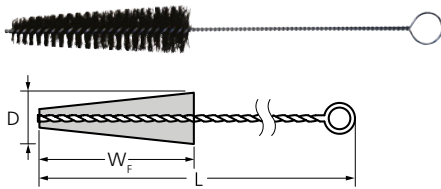

### Loop handle hand tube brushes, conical

Specially suited to brushing in manual applications. Conical type.

**Special features:**

- Maximum precision and efficiency when working on delicate workpieces.
- Optimal access to hard-to-reach areas such as the inner surfaces of pipes and drilled holes.

D [Inch]	W <sub>F</sub> [Inch]	L [Inch]		Item no.	EDP no.
<b>Black Horsehair, Tapered</b>					
1-1/4 to 3/4	5	12	1	79189586	89586

## Fitting brushes

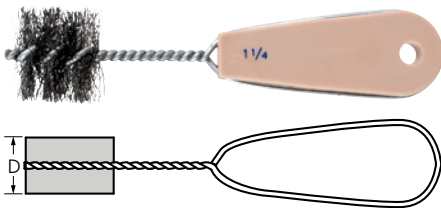

### Internal tube fitting brushes

For internal cleaning and preparation of metal tubes and joints.

**Special features:**

- Equipped with ergonomic handle for comfortable use.

Nominal tubing [Inch]	D [Inch]		Item no.	EDP no.
<b>Steel wire (ST)</b>				
1/8	17/64	12	79189625	89625
1/4	25/64	12	79189626	89626
3/8	33/64	12	79189627	89627
1/2	21/32	12	79189628	89628
5/8	25/32	12	79189629	89629
3/4	29/32	12	79189630	89630
7/8	1-1/32	12	79189631	89631
1	1-5/32	12	79189632	89632
1-1/4	1-7/16	12	79189633	89633
1 1/2	1-11/16	12	79189634	89634
2	2-3/16	12	79189635	89635

# Tube brushes

## Fitting brushes



### External tube fitting brushes

For external cleaning and preparation of metal tubes and joints.

**Special features:**

- Plastic casing protects user's hands from sharp wire tips and pipe edges.

Nominal tubing [Inch]	D [Inch]		Item no.	EDP no.
<b>Steel wire (ST)</b>				
3/8	1/4	6	79189636	89636
1/2	3/8	6	79189637	89637
5/8	1/2	6	79189638	89638
3/4	5/8	6	79189639	89639
7/8	3/4	6	79189640	89640
1	7/8	6	79189641	89641



The Universal Line offers a range of brushes in the most common profiles and dimensions. Developed for general and cost-efficient use and for the most common applications. Manufactured to the usual high quality standards according to EN 1083.



### Threaded cup brushes, crimped

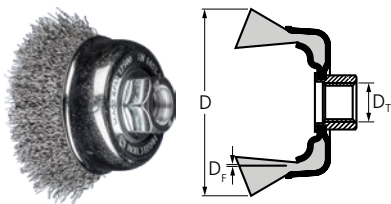

#### Crimped shank mounted

Excellent for medium-duty brushing such as deburring, cleaning, and derusting of large surfaces.

#### Special features:

- Highly flexible, enabling optimal adaptation to the workpiece contour.
- Creates fine surfaces.

D [Inch]	L <sub>T</sub> [Inch]	D <sub>T</sub>	D <sub>F</sub> [Inch]	Opt. RPM	Max. RPM		Item no.	EDP no.
<b>Steel wire (ST)</b>								
2-3/4	7/8	5/8-11	.012	7,000 – 12,500	12,500	5	43740005	763889
3-1/2	7/8	5/8-11	.012	7,000 – 12,000	12,000	5	43740007	764091
			.020	7,000 – 12,000	12,000	5	43740008	764107

### Threaded cup brushes, knotted

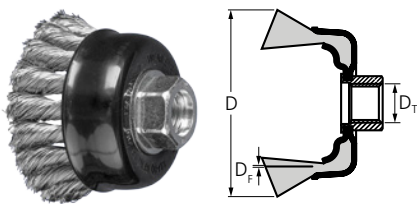

#### Single row, full cable twist

Aggressive brush. Excellent for heavy-duty brushing applications like deburring, cleaning, derusting, descaling, and removal of spatter.

#### Special features:

- Aggressive brushing effect due to the very stiff knotted wire.

D [Inch]	L <sub>T</sub> [Inch]	D <sub>T</sub>	D <sub>F</sub> [Inch]	Opt. RPM	Max. RPM		Item no.	EDP no.
<b>Steel wire (ST)</b>								
2-3/4	3/4	5/8-11	.014	7,000 – 12,500	12,500	5	43740019	764237
			.020	7,000 – 12,500	12,500	5	43740021	764251
						10	47701722	145463
3-1/2	3/4	5/8-11	.020	5,500 – 11,000	11,000	5	43740025	763865
4	1	5/8-11	.014	4,500 – 9,000	9,000	2	43740026	763896
5	1-1/8	5/8-11	.014	3,500 – 7,000	7,000	2	43740034	763971

Continued on next page

# Universal brushes

## Threaded cup brushes, knotted



D [Inch]	L <sub>T</sub> [Inch]	D <sub>T</sub>	D <sub>F</sub> [Inch]	Opt. RPM	Max. RPM		Item no.	EDP no.
<b>Stainless steel wire (INOX)</b>								
2-3/4	3/4	5/8-11	.014	7,000 – 12,500	12,500	5	43740020	764244
			.020	7,000 – 12,500	12,500	5	43740022	764268
						10	47701723	145586

## Wheel brushes, crimped for angle grinders

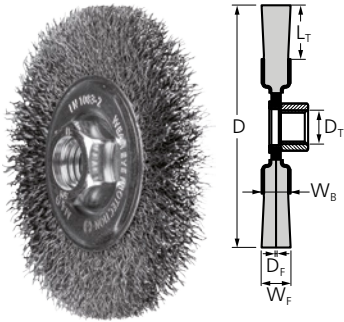

### Crimped wheel for angle grinders

Designed for medium-duty brushing such as derusting, cleaning of weld seams and light deburring work.

#### Special features:

- Designed for use on angle grinders up to 15,800 SFPM.
- Highly flexible, enabling optimal adjustment to the workpiece contour and less heat build-up.
- Creates fine surfaces.

D [Inch]	W <sub>F</sub> [Inch]	L <sub>T</sub> [Inch]	D <sub>T</sub>	D <sub>F</sub> [Inch]	Opt. RPM	Max. RPM		Item no.	EDP no.
<b>Steel wire (ST)</b>									
4	9/16	7/8	5/8-11	.012	7,000 – 12,500	12,500	5	43740011	764145

## Wheel brushes, knotted

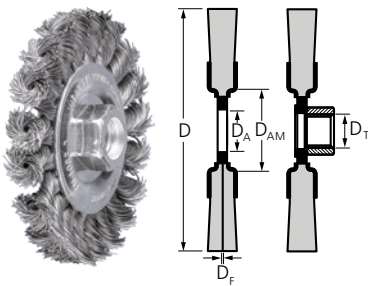

### Knot wire, full cable twist

Aggressive brush. Designed for heavy-duty brushing in metalwork such as descaling, derusting, deburring, cleaning of weld seams, removal of adhesive residues and spatter.

#### Special features:

- Aggressive brushing action due to tightly-twisted wire knots.
- Cost-efficient and designed for general use.

D [Inch]	W <sub>F</sub> [Inch]	L <sub>T</sub> [Inch]	D <sub>T</sub>	D <sub>F</sub> [Inch]	Opt. RPM	Max. RPM		Item no.	EDP no.
<b>Steel wire (ST)</b>									
4	5/8	3/4	5/8-11	.020	10,000 – 15,000	20,000	5	43740029	763926
6	1/2	1-1/4	5/8-1/2	.014	4,500 – 9,000	9,000	5	43740035	763988



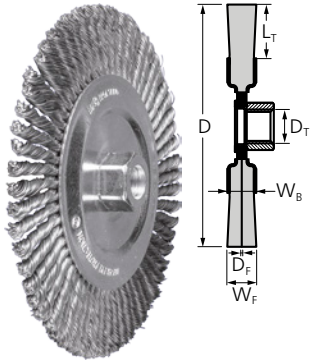

### Stringer bead twist

Aggressive and robust brush that is able to withstand high mechanical loads. Ideal for heavy-duty brushing in pipeline and container construction.

#### Special features:

- Aggressive brushing action due to tightly-twisted wire knots.
- Extra-slim design allows access to hard-to-reach areas such as root weld seams.

D [Inch]	W <sub>F</sub> [Inch]	L <sub>T</sub> [Inch]	D <sub>T</sub>	D <sub>F</sub> [Inch]	Knots	Opt. RPM	Max. RPM		Item no.	EDP no.
<b>Steel wire (ST)</b>										
4	3/16	3/4	5/8-11	.020	30	10,000 – 15,000	20,000	5	43740031	763940
								10	47701719	143438
6	3/16	1-1/4	5/8-11	.020	40	4,500 – 9,000	9,000	5	43740038	764015
								10	47701720	144404
6-7/8	3/16	1-3/8	5/8-11	.020	60	4,500 – 9,000	9,000	5	43740040	764039
<b>Stainless steel wire (INOX)</b>										
4	3/16	3/4	5/8-11	.020	30	10,000 – 15,000	20,000	5	43740032	763957
								10	47701721	145401
6	3/16	1-1/4	5/8-11	.020	40	4,500 – 9,000	9,000	5	43740039	764022

## Wheel brushes, crimped

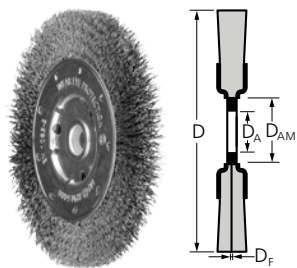

### Narrow face

Excellent for medium-duty hand-held or automated brushing of workpieces with large surfaces. Can be used with all commercially available stationary drive systems and bench grinders due to the variable hole diameter.

#### Special features:

- Can be used with all common stationary drive systems and bench grinders.
- The special design enables several brushes to be attached in a row to create wide gap-less rollers.
- Highly flexible, enabling optimal adjustment to the workpiece contour. Creates fine surfaces.

D [Inch]	W <sub>F</sub> [Inch]	L <sub>T</sub> [Inch]	D <sub>A</sub>	D <sub>AM</sub> [Inch]	D <sub>F</sub> [Inch]	Opt. RPM	Max. RPM		Item no.	EDP no.
<b>Steel wire (ST)</b>										
6	1/2	1-1/4	1/2	5/8	.012	3,000 – 6,000	6,000	5	43740016	764206

# Universal brushes

## Wheel brushes, crimped

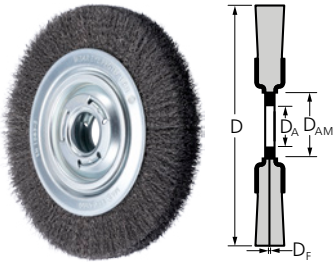

### Crimped wire

Excellent for medium-duty hand-held or automated brushing of large workpieces. Designed for universal workshop use.

#### Special features:

- Can be used with all common stationary drive systems and bench grinders.
- Highly flexible, enabling optimal adaptation to the workpiece contour.
- Creates fine surfaces.

D [Inch]	W <sub>F</sub> [Inch]	L <sub>T</sub> [Inch]	D <sub>A</sub>	D <sub>AM</sub> [Inch]	D <sub>F</sub> [Inch]	Opt. RPM	Max. RPM		Item no.	EDP no.
<b>Steel wire (ST)</b>										
6	1	1-1/4	1-1/4	2	.012	3,000 – 6,000	6,000	5	43740015	764190
8	1-1/4	1-1/4	1-1/4	2	.012	2,300 – 3,500	4,500	5	43740017	764213

## Shank-mounted end brushes, crimped

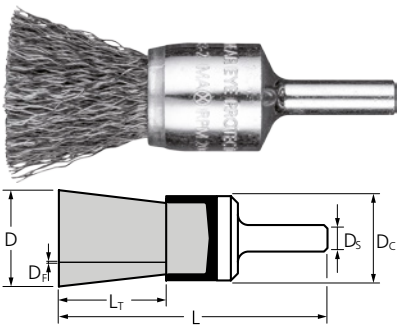

### Crimped wire

Designed for light brushing such as deburring, cleaning and derusting.

#### Special features:

- Optimal access to hard-to-reach areas, such as drilled holes and crevices, as the filament spreads out upon rotation.
- Highly flexible, enabling optimal adaptation to the workpiece contour.
- Creates fine surfaces.

D [Inch]	D <sub>C</sub> [Inch]	D <sub>S</sub> [Inch]	L <sub>T</sub> [Inch]	D <sub>F</sub> [Inch]	Opt. RPM	Max. RPM		Item no.	EDP no.
<b>Steel wire (ST)</b>									
3/4	13/16	1/4	1	.012	10,000 – 15,000	20,000	5	43740058	764411
1	1-5/32	1/4	1	.012	8,000 – 11,000	20,000	5	43740061	764442
				.020	8,000 – 11,000	20,000	5	43740062	764459
							10	47701726	145920
<b>Stainless steel wire (INOX)</b>									
3/4	13/16	1/4	1	.012	10,000 – 15,000	20,000	5	43740060	764435
1	1-5/32	1/4	1	.020	8,000 – 11,000	20,000	5	43740063	764466





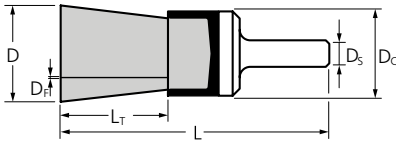

### Knot wire

Aggressive brush. Designed for medium-duty brushing such as deburring, cleaning, derusting and descaling, as well as removing spatter.

#### Special features:

- Use variable speed power tools to control the spread of the brush.
- Optimal access to hard-to-reach areas such as recesses and drilled holes.

D [Inch]	D <sub>c</sub> [Inch]	D <sub>s</sub> [Inch]	L <sub>r</sub> [Inch]	D <sub>f</sub> [Inch]	Opt. RPM	Max. RPM		Item no.	EDP no.
<b>Steel wire (ST)</b>									
3/4	7/8	1/4	1	.014	10,000 – 15,000	20,000	5	43740052	764350
1	1-5/32	1/4	1	.014	8,000 – 11,000	20,000	5	43740056	764398
				.020	8,000 – 11,000	20,000	5	43740054	764374
							10	47701724	145623
<b>Stainless steel wire (INOX)</b>									
3/4	7/8	1/4	1	.020	10,000 – 15,000	20,000	5	43740053	764367
1	1-5/32	1/4	1	.014	8,000 – 11,000	20,000	5	43740057	764404
							10	47701725	145876
				.020	8,000 – 11,000	20,000	5	43740055	764381

## Shank-mounted universal cup brushes, crimped

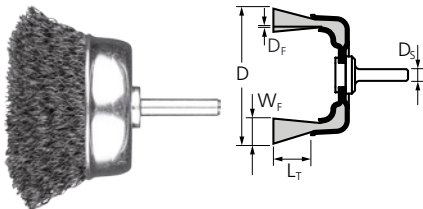

### Crimped cup

Designed for cleaning, derusting and smoothing. Perfect tool for the removal of corrosion and paint. Ideal for brushing on large, flat and easily accessible surfaces with the entire brush face applied to the workpiece.

#### Special features:

- Highly flexible, enabling optimal adaptation to the workpiece contour.
- Creates fine surfaces.

D [Inch]	Grit size	D <sub>f</sub> [Inch]	D <sub>s</sub> [Inch]	L <sub>r</sub> [Inch]	Max. RPM		Item no.	EDP no.
<b>Steel wire (ST)</b>								
2	-	.012	1/4	3/4	13,000	5	43740003	763858
<b>M-BRAD® nylon abrasive filament, silicon carbide SiC</b>								
3	120	.040	1/4	3/4	4,500	5	43740001	763834

# Universal brushes

## Shank-mounted universal wheel brushes, crimped

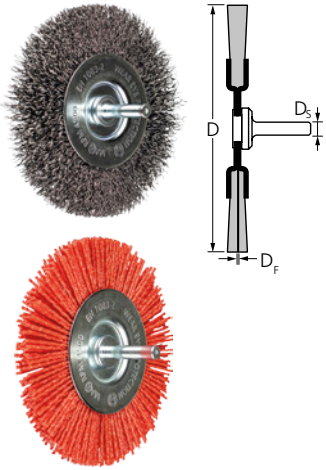

### Crimped wheel for power drills

Designed for cleaning, derusting, smoothing, cleaning of weld seams, light deburring, and removal of corrosion and paint. Specially developed for use within a low rotational speed range on cordless drills and power drills.

**Special features:**

- Highly flexible, enabling optimal adaptation to the workpiece contour.
- Creates fine surfaces.

D [Inch]	Grit size	D <sub>F</sub> [Inch]	D <sub>S</sub> [Inch]	L <sub>T</sub> [Inch]	Max. RPM		Item no.	EDP no.
<b>Silicon carbide (SiC)</b>								
3	120	.040	1/4	3/4	4,500	5	43740002	763841

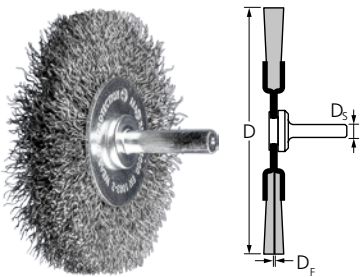

### Crimped wheel for straight grinder

Designed for cleaning, derusting, smoothing, cleaning of weld seams, light deburring, and removal of corrosion and paint.

**Special features:**

- Highly flexible, enabling optimal adaptation to the workpiece contour.
- Creates fine surfaces.

D [Inch]	D <sub>F</sub> [Inch]	D <sub>S</sub> [Inch]	L <sub>T</sub> [Inch]	Max. RPM		Item no.	EDP no.
<b>Steel wire (ST)</b>							
2	.012	1/4	1/2	20,000	5	43740004	763872
3	.012	1/4	3/8	20,000	5	43740006	764084



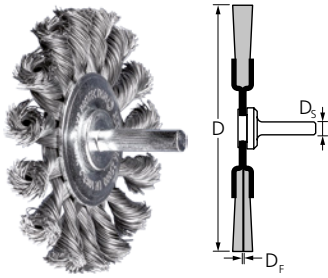

### Knot wire, full cable twist

Aggressive brush for cleaning, derusting and work on weld seams.

#### Special features:

- Aggressive brushing action due to tightly-twisted wire knots.
- Optimal access to hard-to-reach areas such as grooves and recesses.

D [Inch]	W <sub>F</sub> [Inch]	L <sub>T</sub> [Inch]	D <sub>F</sub> [Inch]	Opt. RPM	Max. RPM		Item no.	EDP no.
<b>Steel wire (ST)</b>								
3	7/16	3/4	.012	12,000 – 18,000	25,000	5	43740023	764275
4	1/2	7/8	.012	10,000 – 15,000	20,000	5	43740030	763933

## Universal scratch brushes, crimped

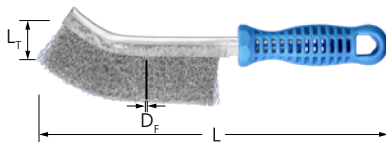

### Metal scratch brushes, plastic grip handle

Excellent for cleaning in hard-to-reach areas, e.g. angles, corners and pipes.

#### Special features:

- Packaged for retail.

Rows	L <sub>T</sub> [Inch]	L [Inch]	D <sub>F</sub> [Inch]		Item no.	EDP no.
<b>Steel wire (ST)</b>						
1	1-1/4	10	.012	10	43740044	764077
<b>Stainless steel wire (INOX)</b>						
1	1-1/4	10	.012	10	43740045	764282
<b>Brass wire</b>						
1	1-1/4	10	.012	10	43740043	764060



### Drive arbors for wheel brushes, chuck type

Enable use of wheel brushes with arbor hole on tool drives with collet, e. g. electric straight grinders and flexible shaft drives. No projecting shank, for brushing work on edges. The brush can be changed without unclamping the shank.

#### Special features:

- Machined metal components for accurate fit.

D <sub>S</sub> [Inch]	Suitable for brush arbor hole dia. [Inch]	Clamping width D <sub>A</sub> / D <sub>M</sub> [Inch]	Head/flange dia. [Inch]	Total length [Inch]		Item no.	EDP no.
1/4	1/4	3/16 – 3/8	9/1	2-1/8	1	79184650	84650
	3/8	3/16 – 3/8	11/16	2-1/8	1	79184651	84651
	1/2	3/16 – 3/8	3/4	2-1/8	5	79184652	84652



### Drive arbors for wheel brushes, flat head

Enable use of wheel brushes with arbor hole on tool drives with collet, e. g. electric straight grinders and flexible shaft drives. No projecting shank, for brushing work on edges. Multiple brushes can be clamped depending on the brush type.

#### Special features:

- Machined metal components for accurate fit.

D <sub>S</sub> [Inch]	Suitable for brush arbor hole dia. [Inch]	Clamping width D <sub>A</sub> / D <sub>M</sub> [Inch]	Head/flange dia. [Inch]	Total length [Inch]		Item no.	EDP no.
1/4	3/8	0 – 1/2	3/4	1-5/8	1	79184654	84654
	1/2	0 – 1/2	15/16	1-7/8	1	79184655	84655
	1/2, 5/8	1/8 – 1/2	15/16	1-7/8	1	79184656	84656



### Drive arbors for wheel brushes, nut type

Enable use of wheel brushes with arbor hole on tool drives with collet, e.g. electric straight grinders and flexible shaft drives. Multiple brushes can be clamped depending on the brush type. The brush can be changed without unclamping the shank.

#### Special features:

- Machined metal components for accurate fit.

D <sub>S</sub> [Inch]	Suitable for brush arbor hole dia. [Inch]	Clamping width D <sub>A</sub> / D <sub>M</sub> [Inch]	Head/flange dia. [Inch]	Total length [Inch]		Item no.	EDP no.
1/4	1/4	0 – 7/8	5/8	2-1/2	1	79184657	84657
	3/8	0 – 7/8	3/4	2-1/2	1	79184658	84658
	1/2	0 – 1/4	7/8	1-3/4	1	79184659	84659

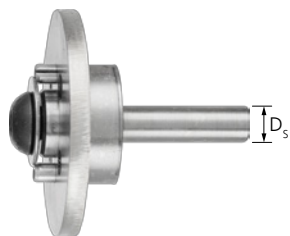

### Drive arbors for M-BRAD® disc brushes

Enables use of composite disc brushes with arbor holes. Suitable for stationary applications with threaded cup brushes on CNC machines, automated centers and robots.

**Special features:**

- Machined metal components for accurate fit.

D <sub>s</sub> [Inch]	Suitable for brush arbor hole dia. [Inch]	Number of drive pins	Drive pin dia. [Inch]	Bolt circle dia. [Inch]		Item no.	EDP no.
3/4	3-4	2	1/4	1-1/4	1	79183982	83982
	5-6	2	1/4	1-1/4	1	79183983	83983
	7-8	3	1/4	3	1	79183984	83984
	9-10	3	1/4	3	1	79183985	83985
1	3-4	2	1/4	1-1/4	1	79183978	83978
	5-6	2	1/4	1-1/4	1	79183979	83979
	7-8	3	1/4	3	1	79183980	83980
	9-10	3	1/4	3	1	79183981	83981

## Adapters



### Arbor hole adapters

PFERD offers various arbor hole adapters for wheel brushes.

**Special features:**

- Enables the use of brushes on all power tools as the hole diameter is adjusted to the required dimension.
- Machined metal components for accurate fit.

Suitable for brush arbor hole dia. [Inch]	Adapter hole dia. D <sub>A</sub>		Item no.	EDP no.
2	1-1/4 Inch, 20 mm, 18 mm, 14 mm, 12 mm	1	79184666	84666
	1-1/4, 1, 7/8, 3/4, 5/8, 1/2 Inch	1	79184665	84665



### Adapter pairs Style C

The adapter pair Style C is suitable for wheel brushes with a brush diameter from 6" in the wide and composite versions.

**Contents:**

The Style C adapter set contains 1 adapter pair.

**Special features:**

- Enable the use of brushes on all tool drives as the hole diameter is adjusted to the required dimension.
- Machined metal components for accurate fit.

Suitable for brush arbor hole dia. [Inch]	Adapter hole dia. D <sub>A</sub> [Inch]		Item no.	EDP no.
2	1	1	79184632	84632
	1/2	1	79184628	84628
	1 1/2	1	79184634	84634
	1-1/4	1	79184633	84633
	3/4	1	79184630	84630
	5/8	1	79184629	84629
	7/8	1	79184631	84631

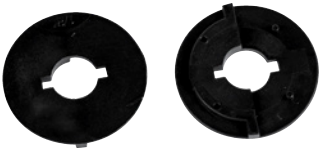

### Adapter pairs Style A

The adapter pair Style A is suitable for wheel brushes with a brush diameter from 6" in the narrow version.

**Contents:**

The Style A adapter set contains 1 adapter pair.

**Special features:**

- Enables the use of brushes on all power tools as the hole diameter is adjusted to the required dimension.
- Machined metal components for accurate fit.

Suitable for brush arbor hole dia. [Inch]	Adapter hole dia. D <sub>A</sub> [Inch]		Item no.	EDP no.
1-1/4	1/2	1	79184605	84605
	5/8	1	79184606	84606
	3/4	1	79184607	84607
	7/8	1	79184608	84608
	1	1	79184609	84609

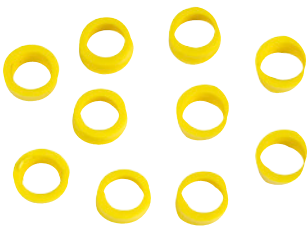

### Adapter Style D

PFERD offers various adapters for wheel brushes with holes.

**Special features:**

- Enables the use of brushes on all power tools as the hole diameter is adjusted to the required dimension.

- Machined metal components for accurate fit.

Suitable for brush arbor hole dia. [Inch]	Adapter hole dia. D <sub>A</sub>		Item no.	EDP no.
3/8	1/4	10	79184600	84600
1/2	1/4	10	79184601	84601
	3/8	10	79184602	84602
5/8	1/2	10	79184603	84603



### Adapter set Style E

For crimped wheel brushes EZmount®.

**Special features:**

- Enables the use of brushes on all power tools as the hole diameter is adjusted to the required dimension.
- Machined metal components for accurate fit.

Suitable for brush arbor hole dia. [Inch]	Adapter hole dia. D <sub>A</sub>		Item no.	EDP no.
2	1, 3/4, 5/8, 1/2	1	79184615	84615

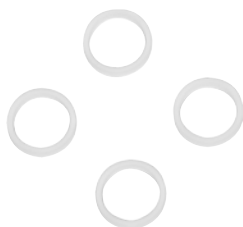

### Adapter Style F

PFERD offers various adapters for wheel brushes with holes.

**Special features:**

- Enables the use of brushes on all power tools as the hole diameter is adjusted to the required dimension.
- Machined metal components for accurate fit.

Suitable for brush arbor hole dia. [Inch]	Adapter hole dia. D <sub>A</sub>		Item no.	EDP no.
5/8	1/2	10	79184636	84636
	3/8	10	79184637	84637
	1/4	10	79184638	84638
1/2	3/8	10	79184639	84639
	1/4	10	79184640	84640
3/8	1/4	10	79184641	84641



### Adapter pairs Style G

PFERD offers various adapters for wheel brushes with holes.

**Contents:**

The Style G adapter set contains 1 adapter pair.

**Special features:**

- Enables the use of brushes on all power tools as the hole diameter is adjusted to the required dimension.
- Machined metal components for accurate fit.

Suitable for brush arbor hole dia. [Inch]	Adapter hole dia. D <sub>A</sub> [Inch]		Item no.	EDP no.
4-1/4	2	1	79184670	84670
5-1/4	2	1	79184671	84671



### Adapter pairs Style H

The adapter pair Style H is suitable for wheel brushes with a brush diameter from 6" in the narrow version.

**Contents:**

The Style H adapter set contains 1 adapter pair.

**Special features:**

- Enables the use of brushes on all power tools as the hole diameter is adjusted to the required dimension.
- Machined metal components for accurate fit.

Suitable for brush arbor hole dia. [Inch]	Adapter hole dia. D <sub>A</sub> [Inch]		Item no.	EDP no.
1-1/4	3/4	1	79184612	84612
	7/8	1	79184613	84613
	1	1	79184614	84614

## Thread adapters



### Thread adapters

Machined metal components for accurate fit.

**Special features:**

- Allows threaded brushes to be adapted to common thread sizes.

Suitable for brush thread	Suitable for spindle thread		Item no.	EDP no.
5/8-11	M10x1.25	5	79184996	84645P
			79184645	84645
	M10x1.50	5	79184997	84646P
			79184646	84646
	3/8-24	5	79184998	84647P
			79184647	84647



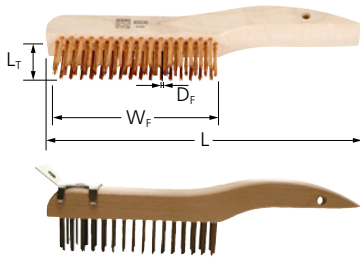

### Shoe handle, hardwood

Designed for all light cleaning and derusting work.

**Special features:**

- Secure anchoring of filament material through the use of hardwood.
- Ergonomic curved handle.

Rows	L <sub>T</sub> [Inch]	L [Inch]	W <sub>F</sub> [Inch]	Filament material	D <sub>F</sub> [Inch]		Item no.	EDP no.
<b>with scraper</b>								
4	1-3/16	10-1/4	5	Steel wire (ST)	.012	12	79185034	85034
<b>without scraper</b>								
2	1-3/16	10	5	Steel wire (ST)	.012	12	79185030	85030
				Stainless steel wire (INOX)	.012	12	79185031	85031
4	1-3/16	10-1/4	5	Bronze	.010	12	79185036	85036
				Steel wire (ST)	.012	12	79185033	85033
				Stainless steel wire (INOX)	.012	12	79185035	85035



### Straight handle with scraper

Aggressive brush with scraper.

**Special features:**

- Scraper for removing heavy dirt.

Rows	L <sub>T</sub> [Inch]	L [Inch]	W <sub>F</sub> [Inch]	D <sub>F</sub> [Inch]		Item no.	EDP no.
<b>Steel wire (ST)</b>							
4	1-1/2	11	4-1/2	.012	12	79185071	85071



### Shoe handle, synthetic

Designed for all light cleaning and derusting work.

**Special features:**

- Synthetic block will not splinter, crack, or rot.
- Ergonomic curved handle.

Rows	L <sub>T</sub> [Inch]	L [Inch]	W <sub>F</sub> [Inch]	D <sub>F</sub> [Inch]		Item no.	EDP no.
<b>Steel wire (ST)</b>							
4	1-3/16	10-1/4	5	.012	12	79185037	85037
<b>Stainless steel wire (INOX)</b>							
4	1-3/16	10-1/4	5	.012	12	79185039	85039

# Scratch brushes

## Scratch brushes

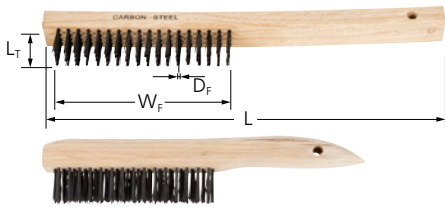

### Shoe handle, hardwood

Designed for all light cleaning and derusting work. Specially developed for semi-professional use and for DIY'ers.

#### Special features:

- Synthetic block will not splinter, crack, or rot.
- Ergonomic curved handle.

Rows	L <sub>T</sub> [Inch]	L [Inch]	W <sub>F</sub> [Inch]	D <sub>F</sub> [Inch]		Item no.	EDP no.
<b>Steel wire (ST)</b>							
3	1-3/16	13-3/4	6	.012	12	79185045	85045
4	1-3/16	10	5	.012	12	79185051	85051
		13-3/4	6	.012	12	79185048	85048
<b>Stainless steel wire (INOX)</b>							
3	1-3/16	13-3/4	6	.012	12	79185047	85047
4	1-3/16	10	5	.012	12	79185053	85053
		13-3/4	6	.012	12	79185050	85050

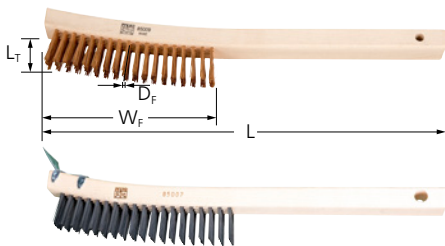

### Curved handle, hardwood

Designed for all light cleaning and derusting work.

#### Special features:

- Secure anchoring of filament material through the use of hardwood.
- Ergonomic curved handle.

Rows	L <sub>T</sub> [Inch]	L [Inch]	W <sub>F</sub> [Inch]	Filament material	D <sub>F</sub> [Inch]		Item no.	EDP no.
<b>without scraper</b>								
3	1-3/16	13-3/4	6-1/4	Bronze	.010	12	79185005	85005
				Steel wire (ST)	.012	12	79185002	85002
				Stainless steel wire (INOX)	.012	12	79185004	85004
4	1-3/16	13-3/4	6-1/4	Bronze	.010	12	79185009	85009
				Steel wire (ST)	.012	12	79185006	85006
				Stainless steel wire (INOX)	.012	12	79185008	85008
<b>with scraper</b>								
3	1-3/16	13-3/4	6-1/4	Steel wire (ST)	.012	12	79185003	85003
4	1-3/16	13-3/4	6-1/4	Steel wire (ST)	.012	12	79185007	85007



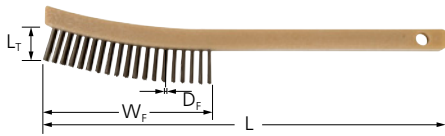

### Shoe handle, synthetic

Designed for cleaning, derusting, and cleaning weld seams and surfaces. Extra-long handle.

#### Special features:

- Synthetic block will not splinter, crack, or rot.

Rows	L <sub>T</sub> [Inch]	L [Inch]	W <sub>F</sub> [Inch]	D <sub>F</sub> [Inch]		Item no.	EDP no.
<b>Steel wire (ST)</b>							
3	1-1/2	13-3/4	6-1/4	.012	12	79185012	85012
4	1-3/16	13-3/4	6-1/4	.012	12	79185016	85016
<b>Stainless steel wire (INOX)</b>							
3	1-1/2	13-3/4	6-1/4	.012	12	79185014	85014
4	1-3/16	13-3/4	6-1/4	.012	12	79185018	85018



### V-Groove

Suitable for cleaning and derusting fillet welds and V-shaped welds due to the V shape.



#### Special features:

- Packaged for retail.

Rows	L <sub>T</sub> [Inch]	L [Inch]	W <sub>F</sub> [Inch]	D <sub>F</sub> [Inch]		Item no.	EDP no.
<b>Steel wire (ST)</b>							
3	1-1/2	13-3/4	5-1/4	.012	12	79185010	85010
<b>Stainless steel wire (INOX)</b>							
3	1-1/2	13-3/4	5-1/4	.012	12	79185011	85011

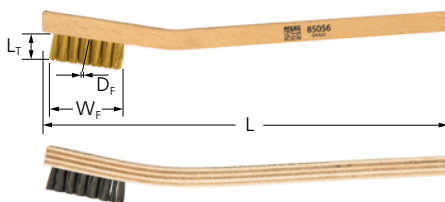

### Welder`s toothbrush, wooden handle

Ideal for cleaning spark plugs, small workpieces and tools.

#### Special features:

- Excellent for the precise cleaning of small weld seams.

Rows	L <sub>T</sub> [Inch]	L [Inch]	W <sub>F</sub> [Inch]	D <sub>F</sub> [Inch]		Item no.	EDP no.
<b>Steel wire (ST)</b>							
3	1/2	7-1/2	1-1/2	.006	36	79185058	85058
						79185054	85054
<b>Stainless steel wire (INOX)</b>							
3	1/2	7-1/2	1-1/2	.006	36	79185059	85059
						79185055	85055
<b>Brass wire</b>							
3	1/2	7-1/2	1-1/2	.006	36	79185056	85056

# Scratch brushes

## Scratch brushes

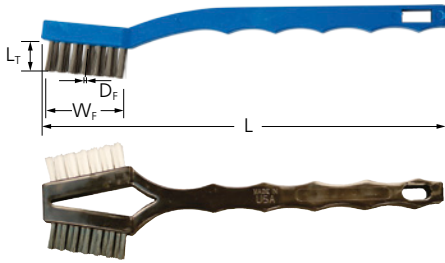

### Welder`s toothbrush, plastic handle

Ideal for cleaning spark plugs, small workpieces and tools. The twin-head version has a side with plastic filament and one with wire filament.

#### Special features:

- Excellent for spot-cleaning small welds and molds.
- Synthetic block will not splinter, crack, or rot.

Rows	L <sub>T</sub> [Inch]	L [Inch]	W <sub>F</sub> [Inch]	D <sub>F</sub> [Inch]		Item no.	EDP no.
<b>Stainless steel wire (INOX)</b>							
3	1/2	7-1/2	1-1/2	.006	36	79185060	85060
						79185063	85063
<b>Brass wire</b>							
3	1/2	7-1/2	1-1/2	.006	36	79185061	85061
						79185064	85064
<b>Nylon plastic filament</b>							
3	1/2	7-1/2	1-1/2	.012	36	79185062	85062



### Small cleaning, curved handle

Ideal for cleaning spark plugs, small workpieces and tools.

#### Special features:

- Ideal for cleaning small weld seams and fillet welds due to narrow filament width.

Rows	L <sub>T</sub> [Inch]	L [Inch]	W <sub>F</sub> [Inch]	D <sub>F</sub> [Inch]		Item no.	EDP no.
<b>Stainless steel wire (INOX)</b>							
2	1/2	8-5/8	2-1/2	.006	36	79185065	85065
<b>Brass wire</b>							
2	1/2	8-5/8	2-1/2	.008	36	79185067	85067

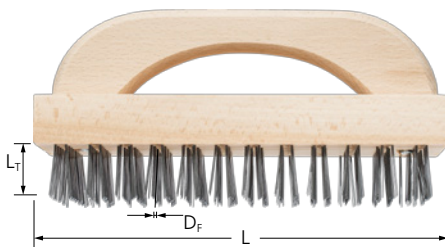

### Hand scrub brushes

Robust block brush made from wood for heavy-duty cleaning work.

#### Special features:

- Excellent for cleaning concrete forms.
- Ergonomic curved handle.

Rows	L <sub>T</sub> [Inch]	L [Inch]	W <sub>F</sub> [Inch]	D <sub>F</sub> [Inch]		Item no.	EDP no.
<b>Steel wire (ST)</b>							
8	1-1/4	9-1/4	3-3/4	.105	12	79185094	85094



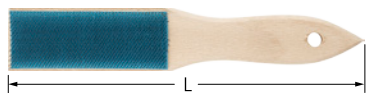

### File card and brush

The file brush easily cleans chips from a loaded file.

**Special features:**

- Packaged for retail.

Rows	L <sub>T</sub> [Inch]	L [Inch]	W <sub>F</sub> [Inch]	D <sub>F</sub> [Inch]		Item no.	EDP no.
<b>Steel wire (ST)</b>							
1	9/32	9-1/8	1-1/2	.012	5	12601000	17146

## Platers and molders brushes

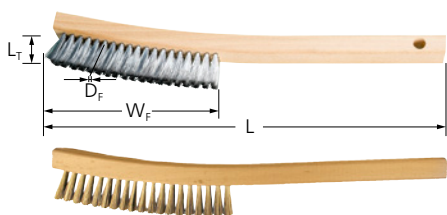

### Curved handle

Fine filament, curved handle brushes designed for gentle brushing action.

**Special features:**

- Light brushing action, removes excess coating in plating applications without altering surface finish.

Rows	L <sub>T</sub> [Inch]	L [Inch]	W <sub>F</sub> [Inch]	D <sub>F</sub> [Inch]		Item no.	EDP no.
<b>Steel wire (ST)</b>							
3	1	13	5-1/2	.006	12	79189542	89542
4	1	13	5-1/2	.005	12	79189543	89543
<b>Stainless steel wire (INOX)</b>							
3	1	13	5-1/2	.006	12	79189546	89546
4	1	13	5-1/2	.005	12	79189547	89547
<b>Brass wire</b>							
3	1	13	5-1/2	.005	12	79189544	89544
4	1	13	5-1/2	.005	12	79189545	89545
<b>Tampico</b>							
4	1	13	5-1/2	-	12	79189540	89540

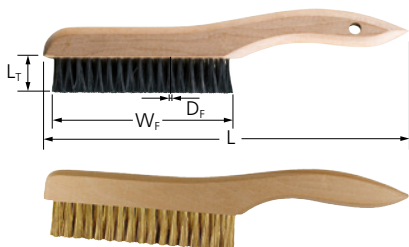

### Shoe handle

Fine filament, curved handle brushes designed for gentle brushing action.

**Special features:**

- Light brushing action, removes excess coating in plating applications without altering surface finish.
- Ergonomic curved handle.

Rows	L <sub>T</sub> [Inch]	L [Inch]	W <sub>F</sub> [Inch]	D <sub>F</sub> [Inch]		Item no.	EDP no.
<b>Steel wire (ST)</b>							
3	1	10	5	.005	12	79189550	89550
4	1	10	5	.005	12	79189551	89551

Continued on next page

# Scratch brushes

## Platers and molders brushes



Rows	L <sub>T</sub> [Inch]	L [Inch]	W <sub>F</sub> [Inch]	D <sub>F</sub> [Inch]		Item no.	EDP no.
<b>Stainless steel wire (INOX)</b>							
4	1	10	5	.006	12	79189539	89539
<b>Brass wire</b>							
3	1	10	5	.005	12	79189552	89552
4	1	10	5	.005	12	79189553	89553
<b>Tampico</b>							
4	1	10	5	-	12	79189548	89548
<b>Nylon plastic filament</b>							
4	1	10	5	.012	12	79189549	89549

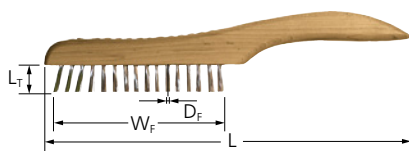

### Shoe handle, narrow face

Fine filament, curved handle brushes designed for gentle brushing action.

#### Special features:

- Light brushing action, removes excess coating in plating applications without altering surface finish.
- Ideal for cleaning narrow grooves.
- Ergonomic curved handle.

Rows	L <sub>T</sub> [Inch]	L [Inch]	W <sub>F</sub> [Inch]	D <sub>F</sub> [Inch]		Item no.	EDP no.
<b>Steel wire (ST)</b>							
1	3/4	10	4-3/4	.006	12	79189555	89555
<b>Stainless steel wire (INOX)</b>							
1	3/4	10	4-3/4	.006	12	79189556	89556

## Block brushes

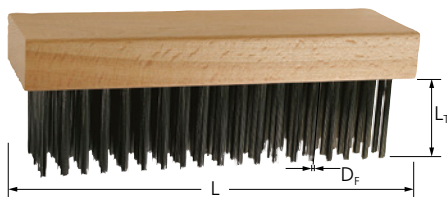

### Standard

Robust block brush made from wood for heavy-duty cleaning work.

#### Special features:

- Excellent for cleaning concrete forms.
- Available in the Curved version with curved handle for ergonomic working.



Rows	L <sub>T</sub> [Inch]	L [Inch]	W <sub>F</sub> [Inch]	D <sub>F</sub> [Inch]		Item no.	EDP no.
<b>Steel wire (ST)</b>							
5	1-3/16	4-1/2	1-1/2	.012	12	79185081	85081
6	1-3/4	7-1/4	2-1/4	.012	12	79185082	85082
9	1-3/16	7-7/8	2-3/8	.012	12	79185084	85084
<b>Stainless steel wire (INOX)</b>							
6	1-3/4	7-1/4	2-1/4	.012	12	79185083	85083

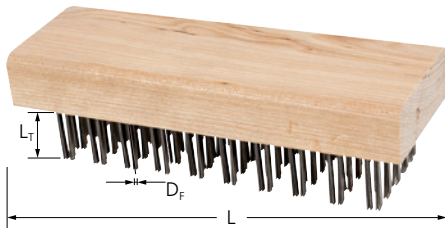

**Flat wire**

Robust block brush made from wood for extremely heavy-duty cleaning work.

**Special features:**

- Flat wire type for aggressive brushing action.
- Ideal for cleaning concrete structures.

Rows	L <sub>T</sub> [Inch]	L [Inch]	W <sub>F</sub> [Inch]	D <sub>F</sub> [Inch]		Item no.	EDP no.
<b>Stainless steel wire (INOX)</b>							
5	1-1/4	7-3/4	2-5/8	.105	12	79185092	85092

# Maintenance brushes

## Chip brushes



### Pipeline dauber brush

Oval-head tampico brushes for hand-applying pipe coatings.

**Special features:**

- High retention improves productivity.

$L_T$ [Inch]	$L$ [Inch]	$W$ [Inch]		Item no.	EDP no.
<b>Wooden block</b>					
2-1/4	17	3-1/2	12	79185100	85100



### Chip brushes

High volume, cost-effective brushes feature natural fiber for painting, gluing, and applying coatings.



**Special features:**

- White filament clearly visible on dark coatings, allowing for easy inspection.

$D$ [Inch]	$W_F$ [Inch]	$L_T$ [Inch]	Filament material		Item no.	EDP no.
<b>Standard thickness</b>						
1/2	1/4	1-1/2	White natural bristles	36	79189695	89695
1	5/16	1-1/2	White natural bristles	36	79189696	89696
1-1/2	5/16	1-1/2	White natural bristles	36	79189697	89697
2	3/8	1-1/2	White natural bristles	24	79189698	89698
2-1/2	3/8	1-1/2	White natural bristles	24	79189699	89699
3	3/8	1-1/2	White natural bristles	24	79189700	89700
4	3/8	1-1/2	White natural bristles	12	79189701	89701







**Metal made chip brushes**

Small, stiff wire brushes for brushing metal chips.



**Special features:**

- 100% metal construction will not burn or melt in high-temperature environments.

L [Inch]	W <sub>F</sub> [Inch]	L <sub>T</sub> [Inch]	Filament material		Item no.	EDP no.
<b>Loop handle</b>						
5-1/2	1-1/4	1-5/8	Steel wire (ST)	12	79185124	85124
			Stainless steel wire (INOX)	12	79185138	85138



**Acid brushes**

Small, high-quality brushes for applying flux film and other coatings.

**Special features:**

- Natural horsehair fibers minimize contamination in brazing and soldering applications.

L [Inch]	W <sub>F</sub> [Inch]	L <sub>T</sub> [Inch]	Filament material		Item no.	EDP no.
<b>Tin handle</b>						
6	1/4	3/4	Horsehair	144	79189601	89601
	3/8	7/8	Horsehair	144	79189602	89602
	1/2	7/8	Horsehair	144	79189603	89603
	9/16	1	Horsehair	144	79189622	89622
	3/4	1	Horsehair	144	79189604	89604

# Maintenance brushes

## Chip brushes



### Chip brushes

Staple-set round carbon steel wire for cleaning chips and shavings.



#### Special features:

- Ideal for cleaning chips from hard-to-reach places.

Rows	L [Inch]	W <sub>F</sub> [Inch]	L <sub>T</sub> [Inch]	Filament material		Item no.	EDP no.
<b>Wooden handle</b>							
4	5-3/4	2-3/4	2-3/8	Steel wire (ST)	12	79189559	89559

## Floor sweeps



### FlexSweep brown plastic fill

The special broom handle bracket provides additional flexibility for challenging brushing tasks. Broom made of sanded hardwood with spliced plastic filament.



#### Special features:

- Handles flex on impact to absorb repetitive shock, making broom handles virtually unbreakable.
- Eliminates need for handle braces, improving accessibility in tight spaces.

L [Inch]	L <sub>T</sub> [Inch]		Item no.	EDP no.
16	5-1/4	1	79185348	85348



### FlexSweep stiff palmyra fill

The special broom handle bracket provides additional flexibility for challenging brushing tasks. Broom made of painted hardwood. Stiff Palmyra fibres for wet or dry brushing on rough concrete or wooden floors.

#### Special features:

- Handles flex on impact to absorb repetitive shock, making broom handles virtually unbreakable.
- Eliminates need for handle braces, improving accessibility in tight spaces.

L [Inch]	L <sub>T</sub> [Inch]		Item no.	EDP no.
18	4	1	79185320	85320



### FlexSweep black synthetic fill

Flexible broom handle bracket for demanding brushing tasks. Broom made of painted hardwood. Excellent for use in workshops and halls. Oil-resistant, washable black synthetic filament with wavy filament in the middle and straight filament around the edge.

**Special features:**

- Handles flex on impact to absorb repetitive shock, making broom handles virtually unbreakable.
- Eliminates need for handle braces, improving accessibility in tight spaces.

L [Inch]	L <sub>T</sub> [Inch]		Item no.	EDP no.
24	3	1	79185236	85236



### FlexSweep brown plastic fill, flagged casing

Street broom made of painted hardwood with brown plastic filament. The combination of spliced and non-spliced filament makes it possible to brush up both coarse dirt as well as dust and grit. For very dirty smooth or rough floors.

**Special features:**

- Handles flex on impact to absorb repetitive shock, making broom handles virtually unbreakable.
- Eliminates need for handle braces, improving accessibility in tight spaces.

L [Inch]	L <sub>T</sub> [Inch]		Item no.	EDP no.
24	3	1	79185241	85241



### Fine sweeping, horsehair/nylon mix

Broom made of painted hardwood. High-quality broom for cleaning fine dirt on smooth floors. Mixed filament made of horsehair and nylon filament.

**Special features:**

- The fine, dense filament ensures a clean surface finish.

L [Inch]	L <sub>T</sub> [Inch]		Item no.	EDP no.
18	3	12	79189214	89214
24	3	12	79189215	89215
36	3	12	79189217	89217



### Fine sweeping, silver flagged-tip plastic

Broom made of painted hardwood. Spliced plastic filament for brushing mirror polished floors and smooth concrete. Even brushes up very fine dust and grit.

**Special features:**

- The fine, dense filament ensures a clean surface finish.

L [Inch]	L <sub>T</sub> [Inch]		Item no.	EDP no.
18	3	12	79189222	89222
24	3	12	79189231	89231
36	3	12	79189225	89225

#### Pre-drilled for compatibility with FlexSweep handle

24	3	12	79189223	89223
30	3	12	79189224	89224

# Maintenance brushes

## Floor sweeps



### Medium sweeping, black synthetic fill

Broom for medium-duty brushing tasks. Broom made of painted hardwood. Excellent for use in workshops and halls. Oil-resistant, washable black synthetic filament with wavy filament in the middle and straight filament around the edge.

#### Special features:

- Good for sweeping both heavy debris and fine dirt like sawdust and shop waste.

L [Inch]	L <sub>T</sub> [Inch]		Item no.	EDP no.
18	3	12	79189234	89234
36	3	12	79189239	89239
<b>Pre-drilled for compatibility with FlexSweep handle</b>				
24	3	12	79189236	89236



### Medium sweeping, brown plastic fill, flagged plastic casing

Broom for medium-duty brushing tasks. Broom made of painted hardwood. The filament rows in the middle brush up coarse pieces of dirt, while the spliced plastic filament around the edge brushes up fine dust and grit.

#### Special features:

- Good for sweeping both heavy debris and fine dirt like sawdust and shop waste.

L [Inch]	L <sub>T</sub> [Inch]		Item no.	EDP no.
24	3	12	79189241	89241
36	3	12	79189243	89243



### Medium sweeping, black tampico fill

Broom for medium-duty brushing tasks. Broom made of painted hardwood. Spliced filament for brushing highly polished floors and smooth concrete. Even brushes up very fine dust and grit.

#### Special features:

- Good for sweeping both heavy debris and fine dirt like sawdust and shop waste.

L [Inch]	L <sub>T</sub> [Inch]		Item no.	EDP no.
18	2-5/8	12	79189249	89249
	3	12	79189250	89250
24	3	12	79189253	89253
30	3	12	79189255	89255
<b>Pre-drilled for compatibility with FlexSweep handle</b>				
24	2-5/8	12	79189252	89252





**Medium sweeping, black tampico fill, horsehair casing**

Broom for medium-duty brushing tasks. Painted hardwood body. With black Tampico filament in the middle, surrounded by soft horsehair.

**Special features:**

- Good for sweeping both heavy debris and fine dirt like sawdust and shop waste.

L [Inch]	L <sub>T</sub> [Inch]		Item no.	EDP no.
18	3	12	79189260	89260
24	3	12	79189261	89261
36	3	12	79189263	89263



**Medium sweeping, black synthetic fill, foam block**

Broom for medium-duty brushing tasks. Body made of foamed plastic with thread. Black plastic bristles for wet or dry brushing of smooth or rough surfaces.

**Special features:**

- Good for sweeping both heavy debris and fine dirt like sawdust and shop waste.

L [Inch]	L <sub>T</sub> [Inch]		Item no.	EDP no.
18	3	12	79189273	89273
24	3	12	79189274	89274



**Medium sweeping, yellow synthetic fill**

Broom for medium-duty brushing tasks. Body made of foamed plastic with thread. Dense, yellow plastic filament. For wet or dry brushing. Extremely versatile: for brushing fine dust or construction rubble.

**Special features:**

- Good for sweeping both heavy debris and fine dirt like sawdust and shop waste.

L [Inch]	L <sub>T</sub> [Inch]		Item no.	EDP no.
24	3	12	79189278	89278

# Maintenance brushes

## Floor sweeps



### Heavy sweeping, brown/red plastic fill

Broom for the most heavy-duty brushing tasks on concrete and other rough surfaces. Broom made of painted hardwood. Water-resistant brown plastic fibres can be used for wet or dry brushing. Oil-resistant and easy to clean.



#### Special features:

- Coarse, long filament, ideal for brushing construction rubble, such as gravel and grit.

L [Inch]	L <sub>T</sub> [Inch]		Item no.	EDP no.
18	3	12	79189285	89285
36	3	12	79189289	89289
<b>Pre-drilled for compatibility with FlexSweep handle</b>				
24	3	12	79189287	89287



### Heavy sweeping, stiff palmyra fill

Broom for the most heavy-duty brushing tasks on concrete and other rough surfaces. Broom made of painted hardwood. Stiff Palmyra fibres for wet or dry brushing on rough concrete or wooden floors.

#### Special features:

- Coarse, long filament, ideal for brushing construction rubble, such as gravel and grit.

L [Inch]	L <sub>T</sub> [Inch]		Item no.	EDP no.
36	4	12	79189325	89325
<b>Pre-drilled for compatibility with FlexSweep handle</b>				
18	4	12	79189320	89320
24	4	12	79189322	89322



### Heavy sweeping, stiff black polypropylene

Broom for the most heavy-duty brushing tasks on concrete and other rough surfaces. Painted hardwood. The stiff black polypropylene filament is grease-resistant and oil-resistant. For wet or dry brushing on rough concrete or asphalt.

#### Special features:

- Coarse, long filament, ideal for brushing construction rubble, such as gravel and grit.

L [Inch]	L <sub>T</sub> [Inch]		Item no.	EDP no.
18	4	12	79189326	89326





### Street brooms, brown polypropylene fill

For challenging applications, in the workshop, garage or street. High-performance street broom. Sanded hardwood. Durable, stiff synthetic fibers with widened end for a long service life.

**Special features:**

- Stiff filament with long trim for sweeping very rough surfaces and debris.
- Can be used for texturing concrete.

L [Inch]	L <sub>T</sub> [Inch]		Item no.	EDP no.
<b>Pre-drilled for compatibility with FlexSweep handle</b>				
16	5-1/4	12	79189348	89348



### Street brooms, red dyed palmyra fill

For challenging applications, in the workshop, garage or street. The angled arrangement of the filament material makes it very well-suited for brushing hard-to-access areas, such as curbs. Made of sanded hardwood with red palmyra filament.

**Special features:**

- Stiff filament with long trim for sweeping very rough surfaces and debris.
- Can be used for texturing concrete.

L [Inch]	L <sub>T</sub> [Inch]		Item no.	EDP no.
16	6-1/4	12	79189351	89351



### Street brooms, safety orange polypropylene fill

For challenging applications, in the workshop, garage or street. Street broom made of sanded hardwood with orange plastic filament. The plastic filament is moisture-resistant and retains its cleaning effect even in wet conditions.

**Special features:**

- Stiff filament with long trim for sweeping very rough surfaces and debris.
- Can be used for texturing concrete.
- The signal orange color of the plastic filament ensures high visibility in the work area.

L [Inch]	L <sub>T</sub> [Inch]		Item no.	EDP no.
16	5	12	79189353	89353
24	5	12	79189355	89355



### Strip brooms, medium synthetic fill

Value-priced metal frame broom for fine sweeping.

**Special features:**

- High-quality synthetic bristles for a long service life.

L [Inch]	L <sub>T</sub> [Inch]		Item no.	EDP no.
24	3-1/4	12	79189315	89315

# Maintenance brushes

## Floor sweeps



### Wire brooms, round steel wire, black tampico border

Steel wire broom for use in industrial environments, e.g. foundries. Broom made of painted hardwood with wire in the middle, surrounded by Tampico filament.

**Special features:**

- Secure anchoring of filament material through the use of hardwood.
- High temperature resistance.

L [Inch]	L <sub>T</sub> [Inch]		Item no.	EDP no.
18	2-7/8	12	79189362	89362
24	2-7/8	12	79189363	89363



### Wire brooms, tempered carbon steel wire, flat

Steel wire broom for use in industrial environments, e.g. foundries. Made of sanded hardwood with hardened flat wire filament. For removing stubborn dirt on uneven and rough services, such as roads and concrete.

**Special features:**

- Secure anchoring of filament material through the use of hardwood.
- High temperature resistance.

L [Inch]	L <sub>T</sub> [Inch]		Item no.	EDP no.
14	5	12	79189370	89370
16	5	12	79189381	89381



### Contractor brooms, silver flagged-tip plastic fill

The special mounting prevents high loads on the broom handle. Painted hardwood. Fine broom for mirror polished floors and smooth concrete. Brushes up very fine dust and grit.



**Special features:**

- Wide range of brooms for fine to coarse sweeping.

L [Inch]	L <sub>T</sub> [Inch]		Item no.	EDP no.
24	3	1	79189295	89295



### Contractor brooms, coarse brown plastic with silver flagged-tip border

The special mounting prevents high loads on the broom handle. Painted hardwood. Core made of stiff brown plastic filament, surrounded by fine spliced filament. For dry brushing on heavily soiled smooth or rough floors.

**Special features:**

- Wide range of brooms for fine to coarse sweeping.

L [Inch]	L <sub>T</sub> [Inch]		Item no.	EDP no.
24	3	1	79189301	89301
30	3	1	79189302	89302





**Contractor brooms, brown palmyra fill**

The special mounting prevents high loads on the broom handle. Painted hardwood. Coarse broom with robust palmyra filament for wet or dry brushing on rough or smooth concrete.

**Special features:**

- Wide range of brooms for fine to coarse sweeping.

L [Inch]	L <sub>T</sub> [Inch]		Item no.	EDP no.
24	4	1	79189304	89304



**Contractor brooms, coarse brown plastic fill**

The special mounting prevents high loads on the broom handle. Street broom for demanding tasks. Sanded hardwood. Coarse broom for wet or dry brushing on concrete and asphalt. Also ideal for industrial brushing tasks.

**Special features:**

- Wide range of brooms for fine to coarse sweeping.

L [Inch]	L <sub>T</sub> [Inch]		Item no.	EDP no.
24	3	1	79189308	89308

**Upright and whisk brooms**



**Upright broom, bass fiber, chisel end**

Traditional broom for general cleaning work. Slim broom for heavy-duty brushwork. This broom has a steel chisel stem for hard-to-remove debris, such as chewing gum. Reinforced with wire band.

**Special features:**

- Available in a variety of natural fibers.

Handle type	L [Inch]	W <sub>F</sub> [Inch]		Item no.	EDP no.
1-1/8" dia. x 39"	55	10	6	79189374	89374



**Upright broom, corn fill**

Traditional broom for general cleaning work. Specially selected corn filament for light brushwork on smooth floors. Compact triple-bound broom with reinforcement wire for a long service life.

**Special features:**

- Available in a variety of natural fibers.

Handle type	L [Inch]	W <sub>F</sub> [Inch]		Item no.	EDP no.
7/8" dia. x 37"	56	10	1	79189376	89376
1-1/8" dia. x 37"	56	11	1	79189377	89377

# Maintenance brushes

## Upright and whisk brooms



### Whisk broom, corn fill

Traditional hand brush for general cleaning work. Metal cap with hanger ring. For removing dust, fluff and fine dirt. Bound three times.

**Special features:**

- Available in a variety of natural fibers.

Handle type	L [Inch]	W <sub>F</sub> [Inch]		Item no.	EDP no.
Metal cap with ring	10	4-1/2	12	79189378	89378



### Whisk broom, palmyra fill

Traditional hand brush for general cleaning work. Wire loop handle made of steel. Cost-efficient broom for brushing up dust. With a reinforcement wire.

**Special features:**

- Available in a variety of natural fibers and handle types.

Handle type	L [Inch]	W <sub>F</sub> [Inch]		Item no.	EDP no.
Wire loop handle	10	4-1/2	12	79189379	89379



### Whisk broom, stiff natural fill

Traditional hand brush for general cleaning work. With wooden handle and a reinforcement wire.

**Special features:**

- Available in a variety of natural fibers and handle types.

Handle type	L [Inch]	W <sub>F</sub> [Inch]		Item no.	EDP no.
Wood grip handle	9-3/4	4-1/2	12	79189380	89380

## Squeegees



### Floor squeegees, heavy duty

For removing dirt and liquid from flat surfaces.

**Special features:**

- Red rubber lip for high flexibility.

L [Inch]	L <sub>T</sub> [Inch]	W <sub>F</sub> [Inch]	Blade material	Frame plating		Item no.	EDP no.
18	2	3/16	Red rubber	Steel	12	79189471	89471
24	2	3/16	Red rubber	Steel	12	79189472	89472



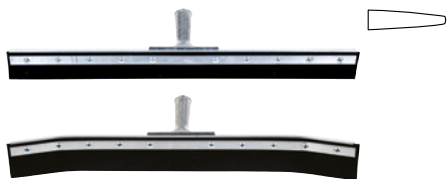

### Floor squeegees, heavy duty

Squeegee for industrial use.



**Special features:**

- Neoprene blade can be used for chemical and petroleum cleaning.

L [Inch]	L <sub>T</sub> [Inch]	W <sub>F</sub> [Inch]	Blade material	Frame plating		Item no.	EDP no.
<b>Heavy duty</b>							
18	2	1/4	Neoprene	Cadmium steel	12	79189473	89473
24	2	1/4	Neoprene	Cadmium steel	12	79189474	89474
30	2	1/4	Neoprene	Cadmium steel	12	79189475	89475
36	2	1/4	Neoprene	Cadmium steel	12	79189476	89476
<b>Heavy duty, curved end</b>							
24	2	1/4	Neoprene	Cadmium steel	12	79189478	89478
30	2	1/4	Neoprene	Cadmium steel	12	79189479	89479
36	2	1/4	Neoprene	Cadmium steel	12	79189480	89480

## Handles and accessories



### Wood handles

Wooden handles made of smooth, lacquered hardwood. Threaded handles feature 3/4" standard acme threaded tips.

**Special features:**

- Easily attach to push brooms.

L [ft]	D [Inch]		Item no.	EDP no.
<b>Wood threads</b>				
5	15/16	12	79189883	89883
6	1-1/8	12	79189887	89887
<b>Tapered end</b>				
4-1/2	1-1/8	12	79189897	89897
5	1-1/8	12	79189899	89899

# Maintenance brushes

## Handles and accessories



### Wood handles

Wooden handles made of smooth, lacquered hardwood. Threaded handles feature 3/4" standard acme threaded tips.

**Special features:**

- Easily attach to push brooms.

L [ft]	D [Inch]		Item no.	EDP no.
<b>Metal threads</b>				
5	15/16	12	79189889	89889
	1-1/8	12	79189891	89891



### Flexible handles

The special broom handle bracket provides additional flexibility for challenging brushing tasks.



**Special features:**

- Handles flex on impact to absorb repetitive shock, making broom handles virtually unbreakable.
- Eliminates need for handle braces, improving accessibility in tight spaces.
- Includes necessary mounting hardware.

L [ft]	D [Inch]		Item no.	EDP no.
<b>FlexSweep handle</b>				
5-1/2	1-1/8	3	79189930	89930



### Fiberglass handles

Broom handles made of glass reinforced plastic with standard thread tip.

**Special features:**

- Lightweight broomstick with long service life.
- Available in the "Flo-Thru" version with water shaft for wash brushes.

L [ft]	D [Inch]		Item no.	EDP no.
<b>Fiberglass handle</b>				
5	15/16	12	79189915	89915
<b>"Flo-Thru" handle</b>				
5	7/8	12	79189919	89919





### Special-purpose handles

Broom handles for special applications.

**Special features:**

- Quick and easy attachment to special connection systems on floor sweeps.

L [ft]	D [Inch]		Item no.	EDP no.
<b>Contractor handle</b>				
5	1-1/8	12	79189901	89901
<b>Strip broom handle</b>				
5	1-1/8	12	79189903	89903



### Handle tip

Converts tapered poles to 3/4" acme threaded poles.

**Special features:**

- Comes with clamping screw for easy attachment.

D [Inch]		Item no.	EDP no.
<b>Metal threads</b>			
15/16	1	79189925	89925



### Handle brace

Reusable galvanized steel braces for use on push brooms.



**Special features:**

- Reinforcement provides added strength and control.

	Item no.	EDP no.
<b>Standard</b>		
1	79189921	89921
<b>Heavy-duty</b>		
1	79189922	89922

# Maintenance brushes

## Dust pans



### Dust pans

Robust enamel-coated metal dustpan.

**Special features:**

- Black enamel allows for a long service life and easy cleaning.

D [Inch]		Item no.	EDP no.
<b>Metal hand dust pan</b>			
12	12	79189876	89876
16	12	79189877	89877

## Utility brushes



### Counter dusters

Hand brush for comfortable, light cleaning and brushing of surfaces, such as counters, tabletops and work surfaces. Available with a wooden or plastic body depending on the version.



**Special features:**

- Fine, dense fill allows for a cleaner surface.

L [Inch]	L <sub>T</sub> [Inch]	Block material	Filament material		Item no.	EDP no.
<b>Premium Line</b>						
9	2-1/4	Wood	Horsehair	12	79189394	89394
<b>Heavy-duty line</b>						
8	2-1/2	Plastic	Black tampico filament	12	79189400	89400





### Wash brushes

Fine filament set in plastic block for washing vehicles, windows, and other surfaces.



#### Special features:

- Soft, flagged synthetic filament will not scratch surfaces.

D [Inch]	L <sub>T</sub> [Inch]	Block material	Filament material		Item no.	EDP no.
<b>Window brush, round</b>						
4-1/2	2-1/2	Plastic	Soft grey flagged synthetic fill	6	79189449	89449



### Wash brushes

Fine filament set in plastic block for washing vehicles, windows, and other surfaces.

#### Special features:

- Soft, flagged synthetic filament will not scratch surfaces.

L [Inch]	L <sub>T</sub> [Inch]	Block material	Filament material		Item no.	EDP no.
<b>Car/truck wash brush, rectangular</b>						
10	2-1/4	Plastic	Black and white flagged synthetic fill	6	79189456	89456

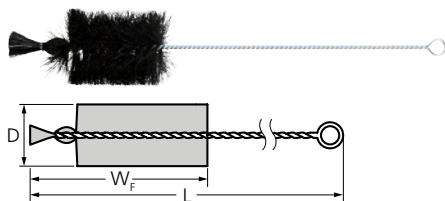

### Hand bottle brushes

For deep cleaning of bottles and narrow, hard-to-reach interiors.

#### Special features:

- Thorough side and bottom cleaning in hard-to-reach places.

D [Inch]	W <sub>F</sub> [Inch]	L [Inch]	Filament material		Item no.	EDP no.
<b>Twisted-in-wire handle</b>						
2-3/4	6-1/2	18	Horsehair	12	79189434	89434
3	6-1/4	18	Horsehair	12	79189435	89435

# Maintenance brushes

## Utility brushes

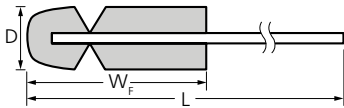

### Can swabbing brush

Wood handle, spiral-wound tampico brush designed for cleaning multi-gallon cans and other containers.

**Special features:**

- Long wooden handle for deep, efficient cleaning.

D [Inch]	W <sub>F</sub> [Inch]	L [Inch]	Filament material		Item no.	EDP no.
<b>Wood handle</b>						
3-3/8	7	25	Grey Tampico	12	79189438	89438



### Deck brushes

Coarse filament set in hardwood block. For scrubbing floors made of wood, composite material, and concrete.

**Special features:**

- Short trim for aggressive cleaning.

L [Inch]	W [Inch]	L <sub>T</sub> [Inch]	Block material	Filament material		Item no.	EDP no.
<b>Regular fill, 6 x 18 rows</b>							
10	2-3/4	2	Hardwood	Polypropylene	12	79189517	89517
				Palmyra	12	79189514	89514
12	2-3/4	1-7/8	Hardwood	Palmyra	12	79189515	89515



### Hand scrub brushes

Wooden hand and nail brush.

**Special features:**

- Plastic filament for a longer service life.

L [Inch]	W [Inch]	L <sub>T</sub> [Inch]	Block material	Filament material		Item no.	EDP no.
5	1-1/2	3/4	Hardwood	Plastic filament	12	79189532	89532







**Fender brushes**

Comfort-grip handle brushes. For general purpose scrubbing and cleaning.



**Special features:**

- Ergonomic handle for improved comfort.

L [Inch]	L <sub>r</sub> [Inch]	Block material	Filament material		Item no.	EDP no.
<b>Long handle</b>						
21-1/2	2	Plastic	Synthetic filament	12	79189439	89439
			White Tampico	12	79189443	89443
<b>Short handle</b>						
10	2	Plastic	Synthetic filament	12	79189444	89444
			White Tampico	12	79189447	89447

**Internal cleaning brushes**

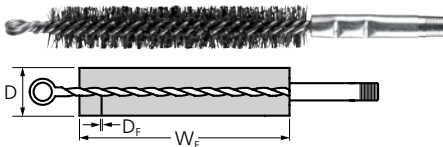

**Condenser tube brushes**

Double stem, double spiral brushes with internal threaded end for handle attachment.

**Special features:**

- Loop end for easy use.

D [Inch]	W <sub>f</sub> [Inch]	Internal thread	External thread	D <sub>f</sub> [Inch]		Item no.	EDP no.
<b>Steel wire (ST)</b>							
1/2	4-1/2	5/16-18	1/8" NPT	.010	1	79189643	89643
5/8	4-1/2	5/16-18	1/8" NPT	.010	1	79189644	89644
3/4	4-1/2	5/16-18	1/8" NPT	.010	1	79189645	89645
7/8	4-1/2	5/16-18	1/8" NPT	.010	1	79189646	89646
1	4-1/2	5/16-18	1/8" NPT	.010	1	79189647	89647

# Maintenance brushes

## Internal cleaning brushes

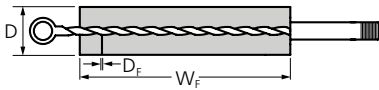

### Flue brushes

Double stem, double spiral brushes with internal threaded end for handle attachment.

#### Special features:

- Loop end for easy use.

D [Inch]	W <sub>F</sub> [Inch]	Internal thread	External thread	D <sub>F</sub> [Inch]		Item no.	EDP no.
<b>Steel wire (ST)</b>							
3/4	4-1/2	1/4" NPT	2-1/2" NPT	.010	1	79189649	89649
1	4-1/2	1/4" NPT	2-1/2" NPT	.010	1	79189651	89651
1-1/4	4-1/2	1/4" NPT	2-1/2" NPT	.010	1	79189652	89652
1-1/2	4-1/2	1/4" NPT	2-1/2" NPT	.010	1	79189653	89653
1-3/4	4-1/2	1/4" NPT	2-1/2" NPT	.010	1	79189654	89654
2	4-1/2	1/4" NPT	2-1/2" NPT	.010	1	79189655	89655
2-1/4	4-1/2	1/4" NPT	2-1/2" NPT	.010	1	79189656	89656
2-1/2	4-1/2	1/4" NPT	2-1/2" NPT	.010	1	79189657	89657
2-3/4	4-1/2	1/4" NPT	2-1/2" NPT	.010	1	79189658	89658
3	4-1/2	1/4" NPT	2-1/2" NPT	.010	1	79189659	89659
3-1/4	4-1/2	1/4" NPT	2-1/2" NPT	.010	1	79189660	89660
3-1/2	4-1/2	1/4" NPT	2-1/2" NPT	.010	1	79189661	89661
3-3/4	4-1/2	1/4" NPT	2-1/2" NPT	.010	1	79189662	89662



### Wire handles

Designed for work with tube brushes with a thread.

#### Special features:

- Optimal access to hard-to-reach areas.
- For a longer overall length, combine the IBUS wire stem with the IBUS extensions.

Thread		Item no.	EDP no.
1/4" NPT	1	79189650	89650



### IBUV extension

Designed for work with tube brushes with a thread.

#### Special features:

- Optimal access to hard-to-reach areas.
- For a longer overall length, combine the IBUV extensions with the IBUS wire stems or with the SWG quick-change handles.

L [Inch]	Thread		Item no.	EDP no.
<b>Galvanized wire handles</b>				
60	1/4" NPT	1	79189648	89648



### Parts cleaning brushes

Pointed-end brushes for removing dust and debris. Synthetic tapered handle.

**Special features:**

- Easy reach into confined areas.

D [Inch]	W <sub>F</sub> [Inch]	Filament material		Item no.	EDP no.
<b>Pointed end</b>					
1	2-3/4	Polypropylene	12	79189612	89612
1-1/16	3	Polypropylene	12	79189613	89613
1-1/4	3	Tampico	12	79189610	89610
<b>Flat end</b>					
1	2-3/4	Polypropylene	12	79189614	89614



### Dome trim brushes

Cleaning brush with curved filament. Optimal for cleaning motors, fans and other small parts.

**Special features:**

- Easy reach into confined areas.

D [Inch]	W <sub>F</sub> [Inch]	Filament material		Item no.	EDP no.
<b>Black bristle filament</b>					
1	2-1/2	Bristle, black	12	79189615	89615
<b>Nylon filament</b>					
1-1/4	2-3/4	Nylon	12	79189616	89616



### Sidewall brushes

For cleaning tire side walls.

**Special features:**

- The smooth hardwood handle provides a comfortable hold.

W <sub>F</sub> [Inch]	L [Inch]	L <sub>T</sub> [Inch]		Item no.	EDP no.
<b>Brass wire</b>					
2-1/2	8-3/4	5/8	12	79189620	89620

# Maintenance brushes

## Paint brushes



### Wall brushes, red plastic handle, natural bristles

Paint brushes with natural bristles are ideal for use with oil-based paints and varnishes.

**Special features:**

- Brush with natural bristles for excellent performance, longevity, and versatile use.

W [Inch]	W <sub>F</sub> [Inch]	L <sub>T</sub> [Inch]		Item no.	EDP no.
1/2	1/4	1-3/4	20	79189711	89711
1-1/4	3/8	1-3/4	20	79189712	89712
2	3/8	1-3/4	20	79189714	89714
2-1/2	3/8	2	12	79189715	89715
3	1/2	1-3/4	10	79189716	89716
4	1/2	2-1/4	10	79189717	89717



### Wall brushes, yellow plastic handle, natural bristles

Paint brushes with natural bristles are ideal for use with oil-based paints and varnishes.

**Special features:**

- Paint brushes with natural bristles are ideal for use with oil-based paints and varnishes.

W [Inch]	W <sub>F</sub> [Inch]	L <sub>T</sub> [Inch]		Item no.	EDP no.
1-1/4	3/8	2	20	79189718	89718
2	1/2	2-1/4	20	79189719	89719
3	1/2	2-1/2	10	79189720	89720
4	5/8	2-3/4	10	79189721	89721



### Wall brushes, wooden handle, natural bristles

Paint brushes with natural bristles are ideal for use with oil-based paints and varnishes.

**Special features:**

- Brush with natural bristles for excellent performance, longevity, and versatile use.



W [Inch]	W <sub>F</sub> [Inch]	L <sub>T</sub> [Inch]		Item no.	EDP no.
2	3/4	3	10	79189724	89724
3	7/8	3-1/4	5	79189725	89725
4	7/8	3-1/2	5	79189726	89726





### Wall brushes, green plastic handle, synthetic bristles

Polyester bristle wall brushes for use with synthetic paints and coatings such as latex paint.

**Special features:**

- Synthetic bristles provide long, durable service life and easy cleaning.

W [Inch]	W <sub>F</sub> [Inch]	L <sub>T</sub> [Inch]		Item no.	EDP no.
1/2	1/4	1-3/4	20	79189734	89734
1-1/4	3/8	1-3/4	20	79189735	89735
2	3/8	2	20	79189737	89737
3	1/2	2	10	79189739	89739
4	1/2	2-1/4	10	79189740	89740



### Wall brushes, yellow plastic handle, synthetic bristle

Polyester bristle wall brushes for use with synthetic paints and coatings such as latex paint.

**Special features:**

- Synthetic bristles provide long, durable service life and easy cleaning.

W [Inch]	W <sub>F</sub> [Inch]	L <sub>T</sub> [Inch]		Item no.	EDP no.
1-1/4	3/8	2	20	79189741	89741
2	1/2	2-1/4	20	79189742	89742
3	1/2	2-1/2	10	79189743	89743
4	5/8	2-3/4	10	79189744	89744



### Wall brushes, wood handle, synthetic bristles

Polyester bristle wall brushes for use with synthetic paints and coatings such as latex paint.

**Special features:**

- Synthetic bristles provide long, durable service life and easy cleaning.

W [Inch]	W <sub>F</sub> [Inch]	L <sub>T</sub> [Inch]		Item no.	EDP no.
1-1/4	1/2	2-1/4	20	79189745	89745
2	5/8	2-1/2	20	79189746	89746
3	3/4	3	10	79189747	89747
4	7/8	3-1/4	10	79189748	89748



### Angular wall brushes, synthetic bristles

Angled trim designed for "cutting in" when painting corners and edges.

**Special features:**

- Synthetic bristles provide long, durable service life and easy cleaning.

W [Inch]	W <sub>F</sub> [Inch]	L <sub>T</sub> [Inch]		Item no.	EDP no.
1-1/2	1/2	2-1/8	10	79189729	89729
2	5/8	2-5/8	10	79189730	89730



# Maintenance brushes

## Paint brushes



### Fitch marking brushes

Natural camel hair bristle brush set in seamless metal ferrule.

**Special features:**

- Versatile, value-priced brushes for use in painting, marking, and dusting.

W <sub>F</sub> [Inch]	Size	L <sub>T</sub> [Inch]		Item no.	EDP no.
9/64	1	5/8	6	79189839	89839
5/32	2	3/4	6	79189840	89840
3/16	3	7/8	6	79189841	89841
1/4	5	1-1/16	6	79189843	89843
9/32	6	1-1/8	6	79189844	89844

## Miscellaneous painters brushes



### Stencil brushes

Stencilling brush for the even application of paint through a stencil.

**Special features:**

- The high filament density and the short, stiff filament prevents color from running under the stencil edges.

W <sub>F</sub> [Inch]	Size	L <sub>T</sub> [Inch]		Item no.	EDP no.
1	6	1-1/8	12	79189860	89860
1-1/4	8	1-1/2	12	79189861	89861
1-1/2	10	1-5/8	12	79189862	89862



### Sash brushes, round

Brush with natural bristles for painting, cleaning, and applying coatings.

**Special features:**

- Versatile brush for cost-efficient use.

W <sub>F</sub> [Inch]	Size	L <sub>T</sub> [Inch]		Item no.	EDP no.
7/8	6	2-1/8	12	79189665	89665
1	8	2-1/8	12	79189666	89666
1-1/8	10	2-1/2	12	79189667	89667



### Sash brushes, oval

Paint brushes with natural bristles are ideal for use with oil-based paints and varnishes.

**Special features:**

- Versatile brush for cost-efficient use.

W <sub>F</sub> [Inch]	Size	L <sub>T</sub> [Inch]		Item no.	EDP no.
1/2	2	1-13/16	12	79189674	89674
13/16	4	2	12	79189675	89675
1	6	2-1/16	12	79189677	89677
1-1/8	8	2-1/4	12	79189678	89678
1-1/4	10	2-1/4	12	79189679	89679



### Economy roller refills

Paint rollers with PVC core for cost-efficient application.

L [Inch]	L <sub>T</sub> [Inch]		Item no.	EDP no.
9	3/8	30	79189753	89753



### General purpose roller refills

Knitted roller refills available in a wide range of pile heights.



#### Special features:

- Provide great coverage with a good surface finish.
- Versatile rollers for a wide range of surface roughnesses.

L [Inch]	L <sub>T</sub> [Inch]		Item no.	EDP no.
3	1/4	20	79189768	89768
4	3/8	20	79189770	89770
9	1/4	30	79189755	89755
	3/8	25	79189756	89756
	1/2	20	79189757	89757
	3/4	16	79189758	89758



### Lint-free roller refills

For use with semi-gloss and high-gloss paints on smooth surfaces.

#### Special features:

- Shed-resistant roller will not contaminate surface finish on smooth surfaces.

L [Inch]	L <sub>T</sub> [Inch]		Item no.	EDP no.
9	1/4	25	79189796	89796



### Time-Trimmer roller refills

Woven fabric rollers for painting in tight spots. Ideal for quick painting jobs on most surfaces.

**Special features:**

- Small diameter gets into tight spots and corners.
- Great surface finish.

L [Inch]	L <sub>T</sub> [Inch]		Item no.	EDP no.
4	7/16	100	79189779	89779
6	7/16	100	79189780	89780



### Economy roller cage

For use with economy roller refills.

**Special features:**

- Value-priced roller cage.

L [Inch]	D [Inch]		Item no.	EDP no.
9	1-1/2	10	79189772	89772



### Trim roller cage

For use with general-purpose trim rollers (3"–4").

**Special features:**

- Handle features internal thread for use with handle extension pole.

L [Inch]	D [Inch]		Item no.	EDP no.
3	1-1/2	24	79189774	89774
4	1-1/2	24	79189775	89775



### Time-Trimmer roller cage

For use with "Time-Trimmer" roller refills.

**Special features:**

- Threaded handle accommodates standard threaded poles.

Frame length [Inch]	Suitable for roll diameter [Inch]		Item no.	EDP no.
12	4–6	20	79189782	89782





**Metal paint tray**

2 qt. capacity tray, for use with all rollers 9" or less.

**Special features:**

- Galvanized metal for long service life.

Capacity [qt]	Dimensions L x W x H [Inch]		Item no.	EDP no.
2	15-3/4 x 11-3/4 x 3	10	79189776	89776



**Time-Trimmer paint tray**

6" width tray to fit "Time Trimmer" rollers. 1 quart capacity.

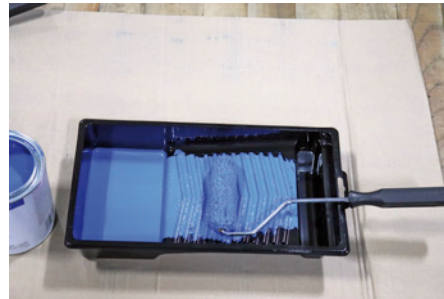

**Special features:**

- Solvent-resistant material.

Capacity [qt]	Dimensions L x W x H [Inch]		Item no.	EDP no.
1	12-3/4 x 6-7/8 x 2-1/4	20	79189784	89784



**Super paint tray**

Professional-grade tray with 4 quart capacity.

**Special features:**

- Solvent-resistant material.
- Impact resistant.
- Disposable liners save cleanup time and mess.

Capacity [gal.]	Dimensions L x W x H [mm]		Item no.	EDP no.
1	15 x 11-1/2 x 3-3/4	10	79189777	89777
		25	79189778	89778



Files



Milling, holemaking and deburring products



Mounted points



Fine grinding and finishing products



Diamond and CBN tools



Cut-off wheels, flap discs and grinding wheels



Cut-off wheels for stationary applications



Industrial power brushes



Power tools



Cutting tools for stationary applications

## New additions to the PFERD product range



Stay up to date and discover our new products digitally and online. Our new products have **blue** item numbers in the Tool Manual.