



Fine grinding and finishing products

Fine grinding and finishing products

Table of contents



Fine grinding and finishing products

■ Highlights from the PFERD range	4
■ General information	5
■ Quick product selection guide	7
■ Coated abrasives	9



COMBICLICK®	
■ Fibre discs	14
■ Non-woven discs	19
■ POLICLEAN® discs	20
■ Felt discs	21
■ Backing pad	21
■ COMBICLICK® set	22



Fibre discs	
■ Fibre discs	24
■ Backing pad	29
■ Stand	30



PSA discs	
■ PSA discs	31
■ PSA disc holders	32

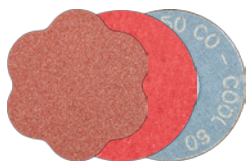

COMBIDISC®	
■ Mini-POLIFAN® CD, CDR	34
■ Drive arbors	35
■ Abrasive discs CD, CDR	36
■ POLICLEAN® discs CD, CDR	46
■ Non-woven discs CD, CDR	47
■ Felt discs CD, CDR	50
■ Abrasive disc backing pad	50
■ COMBIDISC® set	51



Flexible abrasives	
■ File belts	54
■ Belts and accessories for pneumatic drums	59
■ Pneumatic drum	60
■ Benchstand and Backstand Belts	60
■ Cloth-backed abrasive sheets BG	64
■ Paper-backed sheets, general-purpose	65
■ Hand pads	67
■ Sanding sponges	68
■ Arbor	68
■ Shop rolls	69
■ Shop rolls and holders	71
■ Non-woven shop rolls	72
■ Abrasive cord	72
■ Hook and loop-backed abrasive discs	73



Abrasive spiral bands	
■ Abrasive spiral bands	75
■ Rubber drum holder	78



POLIROLL® cartridge rolls	
■ POLIROLL® cartridge rolls	79
■ Drive arbor	81



POLICAP®	
■ POLICAP® Cylindrical, shape A	83
■ Matching POLICAP® abrasive cap holder in cylindrical shape A	83
■ POLICAP® set, cylindrical, shape A	84
■ POLICAP® Cylindrical with radius end, shape C	84
■ Matching POLICAP® abrasive cap holder in cylindrical shape C with radius end	85
■ POLICAP® set, cylindrical with radius end, shape C	86
■ POLICAP® Cylindrical with pointed cone end, shape G	86
■ Matching POLICAP® abrasive cap holder in tapered shape G with radius end	87
■ POLICAP® set, cylindrical with pointed cone end, shape G	87
■ POLICAP® Tapered with radius end, shape L	88
■ Matching POLICAP® abrasive cap holder in conical shape L with radius end	89
■ POLICAP® sets	89
■ POLICAP® abrasive cones, conical shape L	90

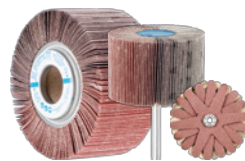

Flap wheels	
■ Mounted flap wheels	93
■ Threaded mounted flap wheel	98
■ Mounted flap wheel – bore polisher	99
■ Unmounted flap wheels and accessories	100
■ Arbor	101
■ Flap wheels for angle grinders	102
■ Flap drums	103
■ General information – POLIFLAP® system	104
■ POLISTAR-TUBE	105
■ Arbor for POLISTAR and POLISTAR-TUBE	106



Non-woven products

■ POLINOX® unitized wheels	110
■ POLINOX® unitized discs	112
■ POLINOX® convolute wheels	114
■ Reducing flanges for POLINOX® convolute wheels	115
■ POLINOX® mounted flap wheels	115
■ POLINOX® cross buffs	118
■ POLINOX® unmounted flap wheels	119
■ POLINOX® unmounted flap wheels, threaded	121
■ POLINOX® grinding discs	122
■ POLINOX® finishing drums	123
■ Accessories	125
■ POLIVLIES® flap discs	126
■ Hook and loop disc holders	128
■ POLICLEAN® products	129



Poliflex® finishing products

■ Rubber bond	133
■ Leather bond	134
■ TX bond	136

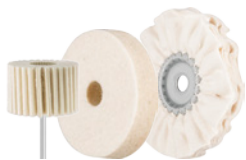

Polishing tools

■ Felt points	137
■ Mounted felt flap wheels	139
■ Felt wheels	140
■ Felt flap discs	140
■ Cloth rings	141
■ Arbor	142
■ Cloth ring drum	142



Grinding and polishing pastes

■ Polishing paste bars and grinding pastes	143
■ Diamond polishing pastes	144
■ Cleaner	144



Fine grinding and finishing products

Highlights from the PFERD range



COMBICLICK®

The COMBICLICK® system consists of a specially developed backing pad and a rugged mounting system at the back of the disc. The backing pad allows COMBICLICK® discs to be used on most available angle grinders. The special geometry of the cooling slots ensures high air throughput, which considerably reduces the thermal load on the abrasive material and the workpiece. The quick-mounting system, rugged fixture, secure attachment of the disc and optimized cooling system help to provide up to 30% lower workpiece temperature, up to 25% increased stock removal, up to 30% longer disc life and improved utilization of the abrasive.

Scan the QR code to find out more about the COMBICLICK® product line.



VICTOGRAIN®

VICTOGRAIN® abrasive material is used to make some of the most effective grinding products in the world. PFERD's triangular, precision-formed grain achieves ultimate performance. The **VICTOGRAIN®** abrasive grain triangles are identical in shape and size and their cutting edges are applied to the workpiece at the optimum angle, meaning the grain needs very little energy to penetrate the workpiece. As a result, the user experiences superior productivity due to: extremely high stock removal, a long service life, and reduced heat build-up in the workpiece.

By combining all these properties together, users benefit from optimal, consistent performance, cool grinding and an extremely long service life with uniform workpiece surface roughness. Scan the QR code to find out more about the **VICTOGRAIN®** products.

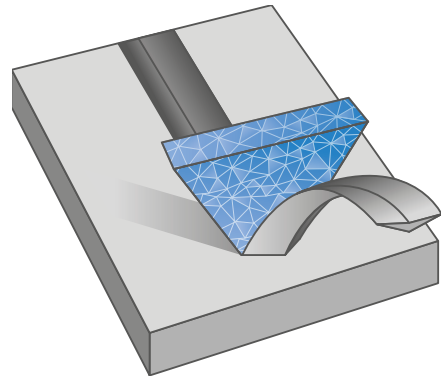

Non-woven products

The use of non-woven abrasives begins where other grinding products reach their limits or no longer achieve the desired results. The elastic properties of the polyamide fibres and the positive effect of the non-woven abrasives result in finishing products which produce outstanding results yet work gently. Non-woven abrasives are water-tight, washable and very durable. They don't load, leave no rust behind on surfaces and are non-conductive.

Non-woven abrasive can be used to outstanding effect for deburring, cleaning and for work on the surfaces of many metals, including aluminum, brass, copper, nickel, stainless steel (INOX) and titanium. It is also ideal for work on other materials which are difficult to grind, such as ceramic, glass and plastic. Non-woven abrasive can be used for wet or dry grinding.



Find additional in-depth information online

Scan the QR code to find out a wide range of tool and application knowledge relating to PFERD's high-quality tools and their huge variety of materials.

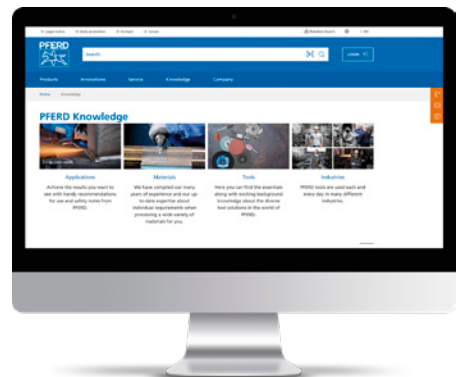

Custom-made products

If you cannot find the solution for your particular application in our extensive catalogue range, we can produce fine grinding and polishing products to meet your requirements in premium PFERD quality specifically for your application upon request. Contact your local sales representatives who will be happy to assist you.



Factors influencing surface roughness:

Factors influencing surface roughness:

- The larger the grit, the rougher the surface finish will be.
- The softer the material to be ground, the coarser the finished surface will be when using the same grit sizes.
- Increasing the peripheral speed slightly improves the surface quality.
- Reducing the speed of the feed rate makes the surface quality slightly finer.



There is a differentiation between the following roughness depths:

- The individual roughness depth R_{zi} is the sum of the height of the largest profile peak and the depth of the largest profile trough within an individual measuring section.
- The roughness depth R_z is the largest individual roughness depths (R_{zi}) of consecutive individual measuring sections.
- The roughness depth R_{max} is the largest individual roughness depth within the overall measuring section.
- The average roughness value R_a is the arithmetic mean value of the sum of all profile values within the roughness profile.

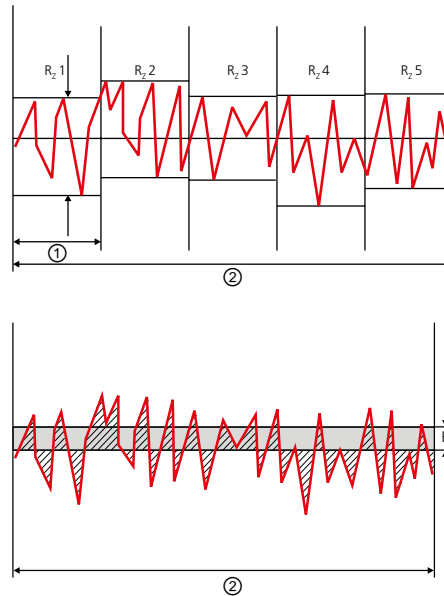

① Individual measuring section
② Overall measuring section

Application	Roughness depth
Coarse stock removal: Grit sizes 24 to 150	$R_a = 0.70$ to $12 \mu\text{m}$ (25 to $270 \mu\text{in}$)
Fine finishing: Grit sizes 180 to 400	$R_a = 0.20$ to $0.70 \mu\text{m}$ (8 to $25 \mu\text{in}$)
Very fine finishing: Grit sizes 500 to 1200	$R_a = 0.05$ to $0.20 \mu\text{m}$ (2 to $8 \mu\text{in}$)
Pharmaceutical grade	$R_a = 0.20$ to $0.70 \mu\text{m}$ (8 to $25 \mu\text{in}$)
Sanitary food grade/ directional matte finish	$R_a = 0.10$ to $0.70 \mu\text{m}$ (4 to $25 \mu\text{in}$)
Polishing: Step 1:	$R_a = 0.10$ to $0.20 \mu\text{m}$ (4 to $8 \mu\text{in}$)
Step 2:	$R_a = 0.04$ to $0.10 \mu\text{m}$ (2 to $4 \mu\text{in}$)
Step 3:	$R_a < 0.01 \mu\text{m}$ ($< 1 \mu\text{in}$)

Reference values for roughness depths in the case of different applications





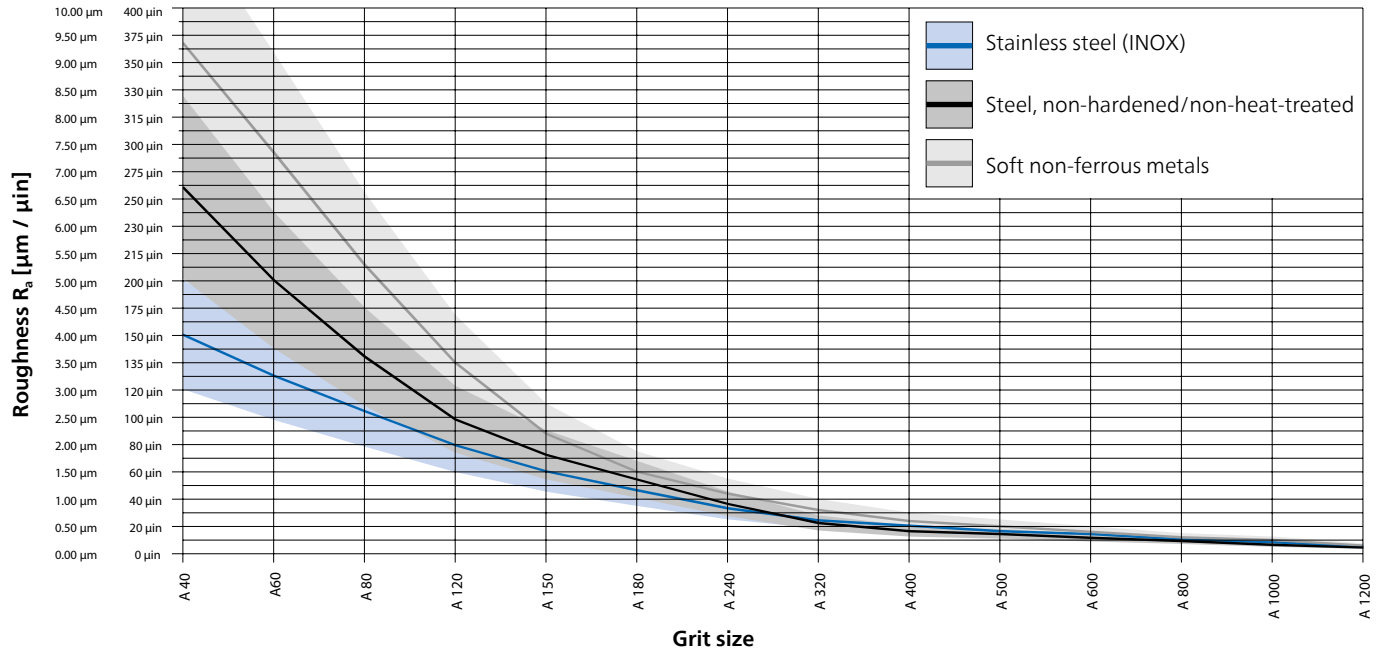



Fine grinding and finishing products

General information



Surface roughness of different materials after machining with products using coated abrasives

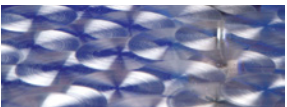











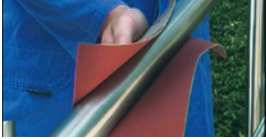







































<p>Work type ▶</p> <p>Work steps ▼</p>	<p>Face-down grinding Products with backing pad</p> 	<p>Belt grinding Products for belt sanders</p> 	
<p>Changing geometrical profiles</p> 	<p>COMBIDISC® ■ Abrasive discs ■ Diamond abrasive discs</p> <p>COMBIDISC® mini fibre discs</p> <p>COMBIDISC® Mini-POLIFAN®</p>	<p>Self-adhesive discs</p> <p>Fibre discs</p> <p>COMBICLICK® fibre discs</p>	<p>Short abrasive belts</p> <p>Long abrasive belts</p>
<p>Step-by-step fine grinding Reducing roughness depths</p> 	<p>COMBIDISC® ■ Abrasive discs ■ Non-woven discs</p> <p>Poliflex® finishing wheels</p> <p>COMBICLICK® non-woven discs</p> <p>POLINOX® unitized discs</p> <p>POLINOX® discs ■ PNL ■ PNZ</p>	<p>Self-adhesive discs</p> <p>PSA discs</p> <p>Velcro-backed abrasive discs</p> <p>Fibre disc</p> <p>COMBICLICK® fibre discs</p>	<p>Short abrasive belts</p> <p>Long abrasive belts</p>
<p>Fine grinding Very fine grinding</p> 	<p>COMBIDISC® ■ Abrasive discs ■ Non-woven discs</p> <p>Poliflex® finishing wheels</p> <p>POLINOX® unitized discs</p>	<p>Fibre discs</p> <p>PSA discs</p> <p>COMBICLICK® fibre discs</p>	<p>Short abrasive belts</p> <p>Long abrasive belts</p> <p>Short surface conditioning belts, non-woven</p>
<p>Cleaning</p> 	<p>COMBIDISC® non-woven discs</p> <p>COMBIDISC® POLICLEAN® PLUS discs</p> <p>COMBICLICK® non-woven discs</p>	<p>POLIVLIES® hook and loop discs</p> <p>POLICLEAN® PLUS discs</p>	<p>Short surface conditioning belts, non-woven</p>
<p>Creating visual effects</p> 	<p>COMBIDISC® non-woven discs</p> <p>POLIVLIES® flap discs</p> <p>POLINOX® discs ■ PNL ■ PNZ</p>	<p>POLIVLIES® hook and loop discs</p> <p>COMBICLICK® non-woven discs</p>	<p>Short surface conditioning belts, non-woven</p>
<p>Polishing</p> 	<p>COMBIDISC® felt discs</p> <p>COMBICLICK® felt discs</p>	<p>Felt flap discs</p>	<p>Short polishing belts, felt</p>



Fine grinding and finishing products

Quick product selection guide



Work type ▶ Work steps ▼	Peripheral grinding Mounted/unmounted products 		Manual grinding 
Changing geometrical profiles 	 Abrasive spiral bands	 POLICAP® seamless abrasive caps	
Step-by-step fine grinding Reducing roughness depths 	 Abrasive spiral bands	 Unmounted flap wheels	 Abrasive sheets Cloth/paper
	 POLIROLL® cartridge rolls	 Unmounted flap wheels for angle grinders	 Shop rolls Cloth/paper
	 POLICAP® seamless abrasive caps	 Flap drums	
	 Mounted flap wheels	 POLISTAR-TUBE	
Fine grinding Very fine grinding 	 POLIROLL® cartridge rolls		 Abrasive sheets Cloth/paper
	 Poliflex® fine grinding points		 Shop rolls Cloth/paper
	 POLINOX® unitized/convolute wheels		 Abrasive cord
Cleaning 	 POLINOX® mounted flap wheels	 POLICLEAN® PLUS wheels	 Abrasive sheets Cloth/paper
	 POLINOX® unmounted flap wheels	 POLICLEAN® PLUS mounted wheels	 POLINOX® hand pads
	 POLINOX® cross buffs		 Shop rolls Cloth/paper
	 POLINOX® finishing drums		 Non-woven shop rolls
Creating visual effects 	 POLINOX® mounted flap wheels	 POLIFLAP® grinding wheel	 POLINOX® hand pads
	 POLINOX® unmounted flap wheels	 Flap drums	 Non-woven shop rolls
	 POLINOX® finishing drums		 High-strength masking tape
Polishing 	 Felt points	 Mounted felt flap wheels	 Diamond polishing pastes
	 Felt wheels	 Cloth rings	 Polishing paste bars
	 Buffing drums		 Grinding pastes

Abrasive grain

PFERD supplies a wide range of products with coated abrasives for machining a variety of workpiece geometries and materials:

- ① Backing material
- ② Base bond
- ③ Coating bond
- ④ Abrasive grain
- ⑤ Active grinding layer

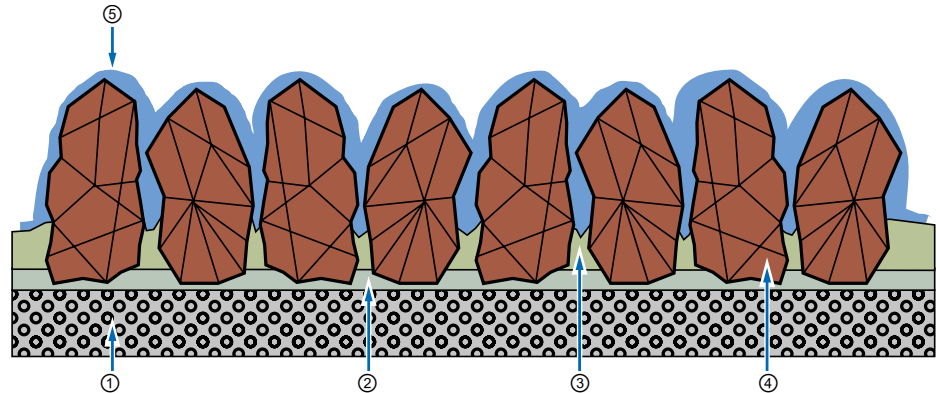

① Backing material

Paper

The main areas of application for coated abrasives with a paper base are in the wood-working industry and in trade, e.g. among carpenters, painters and decorators.

Cloth

Coated abrasives with a cloth base are predominantly used for metalworking.

Vulcanized fibre

When adapted to the corresponding applications, vulcanized fibre in various thicknesses is predominantly used for making fibre grinding discs. Vulcanized fibre is a very sturdy, robust backing material, and also very wear-resistant.

② + ③ bond

When manufacturing coated abrasives, different resin bonds are used to fix the abrasive grain to the backing material. First, the backing material is coated with the base bond ②. After this, the abrasive grain is evenly scattered over the surface and aligned to achieve higher aggressiveness with the help of special procedures. The coating bond ③ ensures that the abrasive grain is fixed in place and protects the grain against the forces and loads resulting from the grinding process.

④ Abrasive grain

Choosing the right abrasive grain has a significant influence on surface quality and productivity. The most common materials for abrasive grain are:

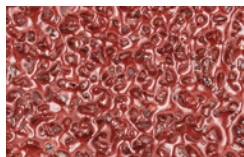

Aluminum oxide A

Numerous types of aluminum oxide are used as abrasives. These may be present in molten or sintered form. The hardness and toughness can be influenced by special manufacturing procedures or additives. Standard types of aluminum oxide and a "sharp-edged" grain shape are predominantly used for coated abrasives.



Silicon carbide SiC

Silicon carbide is synthetically manufactured abrasive grain which has very sharp edges, with low toughness and very high hardness. It is recommended for work on titanium, aluminum, bronze, stone and plastics. Ideally suited for use in the aeronautical industry, especially where SiC is the only approved abrasive, e.g. for use on engine components.



Zirconia, Z

Zirconia alumina is a fused mixture of aluminum oxide and zirconium oxide. In comparison to aluminum oxides, zirconia alumina exhibits lower hardness but greater toughness. The high proportion of zirconium oxide results in an extremely powerful self-sharpening effect and contributes to outstanding stock removal rates with cool grinding and a long service life.



Fine grinding and finishing products

Coated abrasives

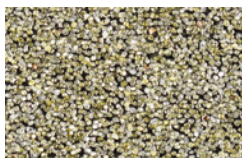

Diamond grain D

Diamond grain is the hardest abrasive. It consists of pure carbon in a crystalline structure. For grinding products, the diamonds used are generally synthetic, produced at very high temperatures and under high pressure. The properties of diamond grain can be adapted for use in grinding products through various synthesis conditions.



Compact grain CK

In the case of compact grain, individual grains are built up as granulate with a bond system. Each individual grain of granulate is one solid unit, in which numerous abrasive grains made from aluminum oxide or silicon carbide (SiC) are joined together. Used abrasive grains are torn out of this compound structure by the forces resulting from the grinding, and expose sharp abrasive points in doing so. This guarantees a long service life with a constant surface quality.

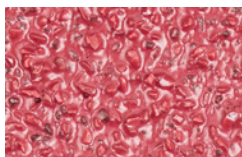

Ceramic CO

For sintered aluminum oxides, a differentiation is made between sintered bauxite aluminum oxides and sol-gel aluminum oxides. Sol-gel aluminum oxides are predominantly used for coated abrasives in the form of abrasive ceramic grain. This state-of-the-art abrasive is used for numerous applications due to its high toughness and good self-sharpening qualities.



VICTOGRAIN®

VICTOGRAIN® abrasive material is used to make some of the most effective grinding products in the world. PFERD's triangular, precision-formed grain achieves ultimate performance. Due to the slim design, VICTOGRAIN® offers an extremely large chip space for maximum cutting efficiency. The structure of the triangular VICTOGRAIN® is specially engineered to maximize results. The very fine crystalline structure ensures optimal wear characteristics as sharp cutting edges are always exposed, with the minimum amount of abrasive breaking off from the triangle. By combining all these properties together, users benefit from optimal, consistent performance, cool grinding and an extremely long service life with uniform workpiece surface roughness.

4

Grit sizes

The various grit sizes for coated abrasives are specified in ISO 6344 and have been adopted for FEPA standards:



Coarse

P 12 – 16 – 20 – 24 – 36 – 40 – 50 – 60 – 80



Medium

P 100 – 120 – 150 – 180 – 220 – 240 – 281



Fine

P 320 – 360 – 400 – 500 – 600



Superfine

P 800 – 1,000 – 1,200 – 1,500

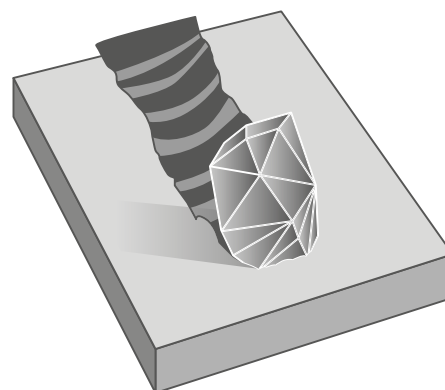

⑤ Active grinding layer

The use of an active grinding layer considerably increases the stock removal rate and reduces the workpiece temperature. This is especially advantageous for materials with poor heat-conducting properties, such as stainless steel (INOX). PFERD products with an active grinding layer feature the additional "COOL" label in their item description.





System

Very easy and comfortable to use.



Clamping

Extremely quick and easy disc changes reduce process costs.

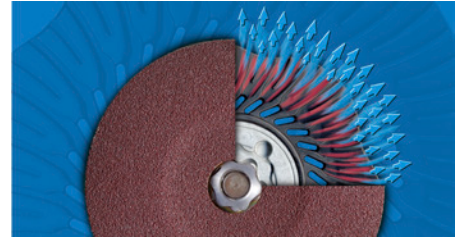

Cooling effect

Very good cooling of the disc and workpiece.



Flexible grinding

Soft and flexible grinding performance during face-down grinding with fibre disc dia. 5 Inch.

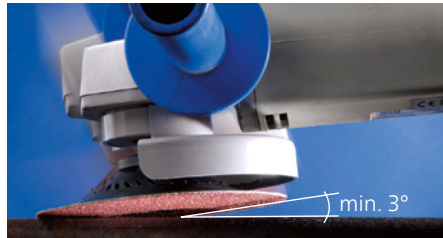

COMBICLICK® can be used at extremely low grinding angles

With COMBICLICK®, scratches caused by protruding clamping parts are prevented and very high utilization of the available abrasive is attained.

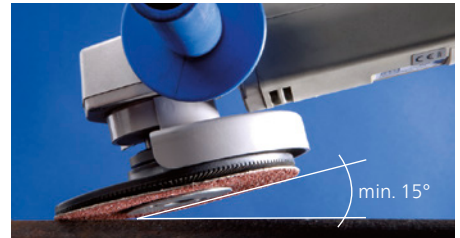

The contact angle for fibre discs is much steeper.

Quick product selection guide

			Abrasive ▶								
Material group ▼			Aluminum oxide A	Zirconia alumina Z	Ceramic oxide grain CO	VICTOGRAIN®	Silicon carbide SiC	Aluminum oxide A-COOL	Ceramic oxide grain CO-COOL	Ceramic oxide grain CO-ALU	VICTOGRAIN®-COOL
Steel, cast steel	Non-hardened, non-heat-treated steels	Construction steels, carbon steels, tool steels, non-alloyed steels, cast steel	●	○	●	●					○
	Hardened, heat-treated steels	Tool steels, tempering steels, alloyed steels, cast steel	○	●	●	●					○
Stainless steel (INOX)	Rust and acid-resistant steels	Austenitic and ferritic stainless steels		○		○		●	●		●
Non-ferrous metals	Soft non-ferrous metals, non-ferrous metals	Soft aluminum alloys	○					●	○	○	
		Brass, copper, zinc	●	○	○					○	
	Hard non-ferrous metals	Hard aluminum alloys	●	○	○		○			○	
		Bronze, titanium		○	○	○	●		●		●
	High-temperature-resistant materials	Nickel-based and cobalt-based alloys		○	○	○		●	○	●	
Cast iron	Grey cast iron, white cast iron	Cast iron with flake graphite, with nodular graphite/nodular cast iron, white annealed cast iron, black annealed cast iron	●	○	●						
Plastics, other materials		Fibre-reinforced plastics, thermoplastics, wood, chipboard, paint	●				●				

● = highly recommended ○ = recommended

Safety notes

- The maximum permitted peripheral speed is 15,800 SFPM.
- For safety reasons, the maximum permitted rotational speed indicated must never be exceeded.



Wear eye protection!



Wear hearing protection!



Wear gloves!



Wear a dust mask!



Use backing pad!



Follow the safety instructions!



Not permitted for wet grinding!



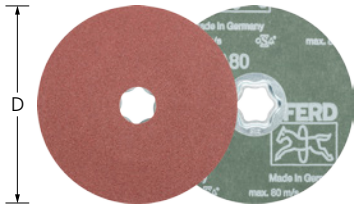

Aluminum oxide A

For universal grinding work from coarse to fine grinding in industry and professional trades.

Special features:

- Innovative quick-mounting system guarantees convenient handling and cool grinding
- High productivity due to long service life and very high stock removal rate. Consistent surface finish resulting from high-quality abrasives.
- Quick disc changes with the innovative COMBICLICK® quick-mounting system. Please order backing pad separately.

D [Inch]	Abrasive	Grit size	Max. RPM		Item no.	EDP no.
4-1/2	A	24	13,300	25	64190002	40091
		36	13,300	25	64190003	40092
		50	13,300	25	64190005	40093
		60	13,300	25	64190006	40094
		80	13,300	25	64190008	40095
		120	13,300	25	64190012	40097
5	A	24	12,200	25	64190102	40099
		36	12,200	25	64190103	40100
		50	12,200	25	64190105	40101
		60	12,200	25	64190106	40102
		80	12,200	25	64190108	40103
		120	12,200	25	64190112	40105



Zirconia alumina Z

For universal coarse grinding with high stock removal and long service life.

Special features:

- Innovative quick-mounting system guarantees convenient handling and cool grinding
- High productivity due to long service life and very high stock removal rate. Consistent surface finish resulting from high-quality abrasives.
- Quick disc changes with the innovative COMBICLICK® quick-mounting system. Please order backing pad separately.

D [Inch]	Abrasive	Grit size	Max. RPM		Item no.	EDP no.
4-1/2	Z	36	13,300	25	64290003	40131
		50	13,300	25	64290005	40132
		60	13,300	25	64290006	40133
		80	13,300	25	64290008	40134
		120	13,300	25	64290012	40136
5	Z	24	12,200	25	64290102	40137
		36	12,200	25	64290103	40138
		50	12,200	25	64290105	40139
		60	12,200	25	64290106	40140
		80	12,200	25	64290108	40141
		120	12,200	25	64290112	40143

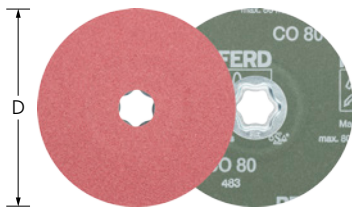

Ceramic oxide grain CO

For aggressive grinding with maximum stock removal; very long service life. Consistently high performance due to self-sharpening ceramic oxide grain, which is specifically designed for work on hard materials and layers.



Special features:

- Innovative quick-mounting system guarantees convenient handling and cool grinding
- High productivity due to long service life and very high stock removal rate. Consistent surface finish resulting from high-quality abrasives.
- Quick disc changes with the innovative COMBICLICK® quick-mounting system. Please order backing pad separately.

D [Inch]	Abrasive	Grit size	Max. RPM		Item no.	EDP no.
4-1/2	CO	24	13,300	25	64192002	40697
		36	13,300	25	64192003	40698
		50	13,300	25	64192005	40699
		60	13,300	25	64192006	40700
		80	13,300	25	64192008	40701
5	CO	24	12,200	25	64192102	40704
		36	12,200	25	64192103	40705
		50	12,200	25	64192105	40706
		60	12,200	25	64192106	40707
		80	12,200	25	64192108	40708

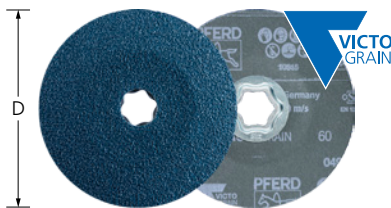

VICTOGRAIN®

For extremely aggressive grinding with an extremely high service life and an outstanding stock removal rate on steel and hard materials. Outstanding, constant high performance due to the VICTOGRAIN® abrasive grain.



Special features:

- Innovative quick-mounting system guarantees convenient handling and cool grinding
- High productivity due to long service life and very high stock removal rate. Consistent surface finish resulting from high-quality abrasives.
- Quick disc changes with the innovative COMBICLICK® quick-mounting system. Please order backing pad separately.

D [Inch]	Abrasive	Grit size	Max. RPM		Item no.	EDP no.
4-1/2	VICTOGRAIN	36	13,300	25	64111636	40371
		60	13,300	25	64111660	40374
		80	13,300	25	64111680	40377
5	VICTOGRAIN	36	12,200	25	64112636	40372
		60	12,200	25	64112660	40375
		80	12,200	25	64112680	40378
7	VICTOGRAIN	36	8,500	25	64118136	40373
		60	8,500	25	64118160	40376
		80	8,500	25	64118180	40379



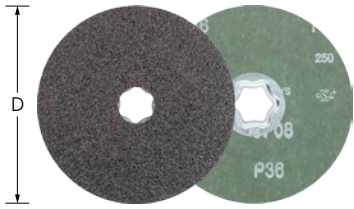

Silicon carbide SiC

For universal grinding work on components made from aluminum, copper, bronze, titanium and fibre-reinforced plastics. Particularly recommended for use on titanium alloys. Ideally suited to use in the aeronautical industry, especially where SiC is the only approved abrasive, e.g. for use on engine components.

Special features:

- Innovative quick-mounting system guarantees convenient handling and cool grinding
- High productivity due to long service life and very high stock removal rate. Consistent surface finish resulting from high-quality abrasives.

- Quick disc changes with the innovative COMBICLICK® quick-mounting system. Please order backing pad separately.

D [Inch]	Abrasive	Grit size	Max. RPM		Item no.	EDP no.
4-1/2	SiC	36	13,300	25	64294003	40021
		60	13,300	25	64294006	40022
		80	13,300	25	64294008	40023
		120	13,300	25	64294012	40024
5	SiC	36	12,200	25	64294103	40028
		60	12,200	25	64294106	40029
		80	12,200	25	64294108	40030
		120	12,200	25	64294112	40031

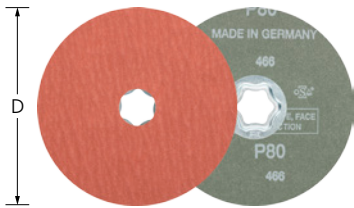

Aluminum oxide A-COOL

For universal grinding work from fine to very fine grinding on materials that do not conduct heat well, e.g. stainless steel (INOX) and aluminum. Active grinding additives in the coating substantially improve the stock removal rate, prevent loading, and result in cooler grinding.

Special features:

- Innovative quick-mounting system guarantees convenient handling and cool grinding
- High productivity due to long service life and very high stock removal rate. Consistent surface finish resulting from high-quality abrasives.

- Quick disc changes with the innovative COMBICLICK® quick-mounting system. Please order backing pad separately.

D [Inch]	Abrasive	Grit size	Max. RPM		Item no.	EDP no.
4-1/2	A-COOL	60	13,300	25	64191006	40302
		80	13,300	25	64191008	40303
		120	13,300	25	64191012	40305
		150	13,300	25	64191015	40306
		220	13,300	25	64191022	40308
5	A-COOL	50	12,200	25	64191105	40310
		60	12,200	25	64191106	40311
		80	12,200	25	64191108	40312
		120	12,200	25	64191112	40314
		150	12,200	25	64191115	40315
		180	12,200	25	64191118	40316
		220	12,200	25	64191122	40317

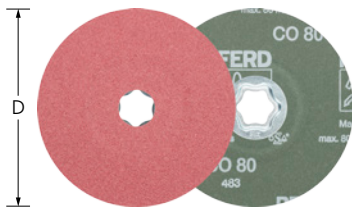

Ceramic oxide grain CO-COOL

Consistently high performance and aggressive grinding due to self-sharpening ceramic oxide grain. Active grinding additives improve the stock removal rate, prevent loading, and result in cooler grinding on hard materials which do not conduct heat well.



Special features:

- Innovative quick-mounting system guarantees convenient handling and cool grinding
- High productivity due to long service life and very high stock removal rate. Consistent surface finish resulting from high-quality abrasives.
- Quick disc changes with the innovative COMBICLICK® quick-mounting system. Please order backing pad separately.

D [Inch]	Abrasive	Grit size	Max. RPM		Item no.	EDP no.
4-1/2	CO-COOL	24	13,300	25	64193002	40725
		36	13,300	25	64193003	40726
		50	13,300	25	64193005	40727
		60	13,300	25	64193006	40728
		80	13,300	25	64193008	40729
		120	13,300	25	64193012	40731
5	CO-COOL	24	12,200	25	64193102	40732
		36	12,200	25	64193103	40733
		50	12,200	25	64193105	40734
		60	12,200	25	64193106	40735
		80	12,200	25	64193108	40736
		120	12,200	25	64193112	40738
7	CO-COOL	24	8,500	25	64193302	40746
		36	8,500	25	64193303	40747
		50	8,500	25	64193305	40748
		60	8,500	25	64193306	40749



Ceramic oxide grain CO-COOL-CONTOUR

Very flexible and adaptable outer contour that does not cut into the workpiece. Consistently high performance and aggressive grinding due to self-sharpening ceramic oxide grain. Active grinding additives improve the stock removal rate, prevent loading and result in cooler grinding.



Special features:

- Innovative quick-mounting system guarantees convenient handling and cool grinding
- High productivity due to long service life and very high stock removal rate. Consistent surface finish resulting from high-quality abrasives.
- Use the CC-GT backing pad with M14 or 5/8" thread to maintain flexibility at the edge of the fibre discs.

D [Inch]	Abrasive	Grit size	Max. RPM		Item no.	EDP no.
5	CO-COOL	60 CONTOUR	12,200	25	64112560	40800
		80 CONTOUR	12,200	25	64112580	40801
		120 CONTOUR	12,200	25	64112512	40802



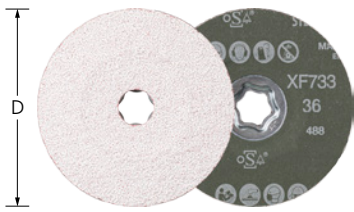

Ceramic oxide grain CO-ALU

For aggressive grinding with maximum stock removal on non-ferrous metals. Consistently high performance due to self-sharpening ceramic oxide grain. Adhesion-reducing additives in the coating prevent loading.

Special features:

- Innovative quick-mounting system guarantees convenient handling and cool grinding
- High productivity due to long service life and very high stock removal rate. Consistent surface finish resulting from high-quality abrasives.

- Quick disc changes with the innovative COMBICLICK® quick-mounting system. Please order backing pad separately.

D [Inch]	Abrasive	Grit size	Max. RPM		Item no.	EDP no.
4-1/2	CO-ALU	36	13,300	25	64194003	40756
		60	13,300	25	64194006	40757
		80	13,300	25	64194008	40758
5	CO-ALU	36	12,200	25	64194103	40759
		60	12,200	25	64194106	40760
		80	12,200	25	64194108	40761



VICTOGRAIN®-COOL

For maximum removal rates with an extremely long service life on steel and materials which are hard or have poor heat-conducting properties. Active grinding additives in the coating substantially improve the stock removal rate, prevent loading and result in cooler grinding.



Special features:

- Innovative quick-mounting system guarantees convenient handling and cool grinding
- High productivity due to long service life and very high stock removal rate. Consistent surface finish resulting from high-quality abrasives.
- Quick disc changes with the innovative COMBICLICK® quick-mounting system. Please order backing pad separately.

D [Inch]	Abrasive	Grit size	Max. RPM		Item no.	EDP no.
4-1/2	VICTOGRAIN-COOL	36	13,300	25	64111536	40380
		60	13,300	25	64111560	40383
		80	13,300	25	64111580	40386
5	VICTOGRAIN-COOL	36	12,200	25	64112536	40381
		60	12,200	25	64112506	40384
		80	12,200	25	64112508	40387
7	VICTOGRAIN-COOL	36	8,500	25	64118036	40382
		60	8,500	25	64118060	40385
		80	8,500	25	64118080	40388

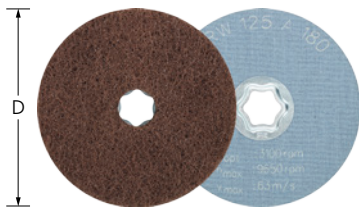

Finishing, soft type

Recommended for very fine grinding on small and medium-sized surfaces and contours, and for cleaning metal and painted surfaces. Achieve matte and satin-finished surfaces. Highly open structure.



Special features:

- Recommended for polishing with polishing paste bars, grinding pastes or diamond polishing pastes in face-down grinding on medium-sized and large surfaces.
- The open structure and high flexibility of the non-woven material prevents loading.
- Innovative quick-mounting system guarantees convenient handling and cool grinding. Please order COMBICLICK® backing pad separately.

D [Inch]	Abrasive	Grit size	Version	Opt. RPM	Max. RPM		Item no.	EDP no.
4-1/2	A	100	medium	3,300	10,500	10	42001052	48131
		180	fine	3,300	10,500	10	42001051	48132
		280	very fine	3,300	10,500	10	42001050	48133
5	A	100	medium	3,100	9,650	10	42001062	48135
		180	fine	3,100	9,650	10	42001061	48136
		280	very fine	3,100	9,650	10	42001060	48137



Surface conditioning, hard type

Designed for universal work on small and medium-sized metal surfaces, e.g. removing rough grinding traces, removing oxidation, and light deburring work. Achieve matte and satin-finished surfaces.



Special features:

- Recommended for polishing with polishing paste bars, grinding pastes or diamond polishing pastes in face-down grinding on medium-sized and large surfaces.
- Little wear due to high tear strength.
- Innovative quick-mounting system guarantees convenient handling and cool grinding. Please order COMBICLICK® backing pad separately.

D [Inch]	Abrasive	Grit size	Version	Opt. RPM	Max. RPM		Item no.	EDP no.
4-1/2	A	100 G	coarse, yellow-brown	3,300	10,500	10	42000052	48100
		180 M	medium, red-brown	3,300	10,500	10	42000051	48101
		240 F	fine, blue	3,300	10,500	10	42000050	48103
5	A	100 G	coarse, yellow-brown	3,100	9,650	10	42000062	48110
		180 M	medium, red-brown	3,100	9,650	10	42000061	48111
		240 F	fine, blue	3,100	9,650	10	42000060	48113





Unitized discs

For achieving a very fine, uniform surface finish which, depending on requirements, is a sufficient preparation for high-gloss polishing. Recommended for work on larger surfaces on components made of stainless steel (INOX).



Special features:

- Recommended for polishing with polishing paste bars, grinding pastes or diamond polishing pastes in face-down grinding on medium-sized and large surfaces.
- High edge strength due to extreme durability.
- Innovative quick-mounting system guarantees convenient handling and cool grinding. Please order COMBICLICK® backing pad separately.

D [mm]	Abrasive	Specification	Version	Grit size	Opt. RPM	Max. RPM		Item no.	EDP no.
4-1/2	SiC	2SF	W (soft)	fine	5,000	8,350	5	42002046	48150
		3SF	MW (medium-soft)	fine	5,000	8,350	5	42002086	48154
		6SF	MH (medium-hard)	fine	5,000	8,350	5	42002146	48158
	A	6AM	MH (medium-hard)	coarse	5,000	8,350	5	47700202	48176
		8AM	H (hard)	fine	5,000	8,350	5	42002182	48162
5	SiC	2SF	W (soft)	fine	4,500	7,650	5	42002056	48166
		3SF	MW (medium-soft)	fine	4,500	7,650	5	42002096	48170
		6SF	MH (medium-hard)	fine	4,500	7,650	5	42002156	48174
	A	6AM	MH (medium-hard)	coarse	4,500	7,650	5	47700203	48180
		8AM	H (hard)	fine	4,500	7,650	5	42002192	48178

POLICLEAN® discs



POLICLEAN® PLUS

POLICLEAN® is a coarsely structured, abrasive, non-woven cleaning fabric made from a special combination of synthetic fibres, resin and abrasive grain. For coarse cleaning work, such as removing paint, scale, heat discoloration, rust and adhesive residue in peripheral grinding on finer surfaces.

Special features:

- High flexibility and open structure mean optimal adaptation to contours and no loading of the product itself.
- The innovative quick-mounting system ensures convenient handling and cool grinding. Please order compatible arbor separately.
- High edge strength due to extreme durability.

D [Inch]	Abrasive	Version		Item no.	EDP no.
4-1/2	A	PCLD PLUS	5	44692275	48125
5	A	PCLD PLUS	5	44692276	48126



Felt discs

Designed for polishing with polishing paste bars, grinding pastes or diamond polishing pastes in face-down grinding on medium-sized and large surfaces.



Special features:

- Recommended for polishing with polishing paste bars, grinding pastes or diamond polishing pastes in face-down grinding on medium-sized and large surfaces.
- High productivity due to very long service life.
- Innovative quick-mounting system guarantees convenient handling and cool grinding. Please order COMBICLICK® backing pad separately.

D [Inch]	Opt. RPM	Max. RPM		Item no.	EDP no.
4-1/2	1,650	10,500	5	42003015	48705
5	1,500	9,650	5	42003025	48706



Backing pad



CC-GT (medium)

With this backing pad, COMBICLICK® products can be used on commercially available angle grinders. Various hardness levels for different applications and results.



Special features:

- Innovative quick-mounting system guarantees convenient handling with fast disc changes.
- The geometry of the cooling slots significantly reduces the thermal load. High productivity due to minimized disc change times.
- The different hardnesses are color-coded: CC-GT (medium) = black; CC-H-GT (hard) = blue; CC-S-GT (soft) = grey.

Suitable for tool diameter [Inch]	Thread	Hardness	Suitable for machine types	Max. RPM		Item no.	EDP no.
4 1/2 and 5	5/8-11	medium	Angle grinders 4-1/2" / 5", spindle 5/8-11"	13,300	1	44890160	69470
5	5/8-11	medium	Angle grinders 5", spindle 5/8-11"	12,200	1	44890161	69472
7	5/8-11	medium	Angle grinders 7", spindle 5/8-11"	8,500	1	44890180	69474

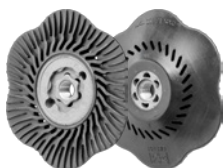

CC-S-GT (soft)

This backing pad allows COMBICLICK® products to be used on commercially available angle grinders.

Special features:

- Innovative quick-mounting system guarantees convenient handling with fast disc changes.
- The geometry of the cooling slots significantly reduces the thermal load. High productivity due to minimized disc change times.

Suitable for tool diameter [Inch]	Thread	Hardness	Suitable for machine types	Max. RPM		Item no.	EDP no.
4 1/2 and 5	5/8-11	soft	Angle grinders 4-1/2" / 5", spindle 5/8-11"	13,300	1	44890163	69469



CC-H-GT (hard)

This backing pad allows COMBICLICK® products to be used on commercially available angle grinders.

Special features:

- Innovative quick-mounting system guarantees convenient handling with fast disc changes.
- The geometry of the cooling slots significantly reduces the thermal load. High productivity due to minimized disc change times.

Suitable for tool diameter [Inch]	Thread	Hardness	Suitable for machine types	Max. RPM		Item no.	EDP no.
4 1/2 and 5	5/8-11	hard	Angle grinders 4-1/2" / 5", spindle 5/8-11"	13,300	1	64199012	69478
5	5/8-11	hard	Angle grinders 5", spindle 5/8-11"	12,200	1	44890162	69473

4

COMBICLICK® set



COMBICLICK® sets

COMBICLICK® sets include a wide variety of coated and non-woven materials to test performance and surface finish results to help determine the right product selections for your applications prior to bulk purchases. The included discs provide solutions for rough grinding, fine grinding, surface conditioning, prepolish and polishing to a mirror finish.

Contents:

Contents - 3 pcs. each of COMBICLICK® fibre discs: CO-COOL 36 grit, CO-COOL 120 grit, A-COOL 220 grit. 1 pc. each of COMBICLICK® non-woven disc: Surface conditioning, hard type, 240 F fine, Surface conditioning, hard type, 180 M medium, Surface conditioning, hard type, 100 C coarse, Finishing, soft type, 280 very fine, Finishing, soft type, 180 fine, Finishing, soft type, 100 medium, Unitized disc SiC W soft. 1 pc. each of: Universal polishing paste, COMBICLICK® felt disc, COMBICLICK® backing pad - CC-GT 5/8-11.

Special features:

- Innovative quick-mounting system guarantees convenient handling with fast disc changes.
- Getting to know and testing the comprehensive system.
- Curated selection of the most common versions.

Diameter [Inch]	Thread		Item no.	EDP no.
4-1/2	5/8-11	1	49350073	48192
5	5/8-11	1	49350074	48194

Quick product selection guide

			Abrasive ▶								
			Aluminum oxide A	Zirconia Alumina Z	Ceramic oxide grain CO	VICTOGRAIN®	Aluminum oxide A-COOL	Zirconia Alumina Z-COOL	Ceramic oxide grain CO-COOL	Ceramic oxide grain CO-ALU	VICTOGRAIN®- COOL
Material group ▼											
Steel, cast steel	Non-hardened, non-heat-treated steels	Construction steels, carbon steels, tool steels, non-alloyed steels, cast steel	•	○	•	•					○
	Hardened, heat-treated steels	Tool steels, tempering steels, alloyed steels, cast steel	○	•	•	•					○
Stainless steel (INOX)	Rust and acid-resistant steels	Austenitic and ferritic stainless steels		○		○	•	•	•		•
Non- ferrous metals	Soft non-ferrous metals, non-ferrous metals	Soft aluminum alloys	○				•	○	○	○	
		Brass, copper, zinc	•	○	○					○	
	Hard non-ferrous metals	Hard aluminum alloys	•	○	○					○	
		Bronze, titanium		○	○	○		•	•		•
	High-temperature- resistant materials	Nickel-based and cobalt-based alloys		○	○	○		•	•	○	•
Cast iron	Grey cast iron, white cast iron	Cast iron with flake graphite, with nodular graphite/nodular cast iron, white annealed cast iron, black annealed cast iron	•	○	•						
Plastics, other materials		Fibre-reinforced plastics, thermoplastics, wood, chipboard, paintwork	•								

• = highly recommended ○ = recommended

Safety notes

- The maximum permitted peripheral speed is 15,800 SFPM.
- For safety reasons, the maximum permitted rotational speed indicated must never be exceeded.



Wear eye protection!



Wear hearing protection!



Wear gloves!



Wear a dust mask!



Use backing pad!



Follow the safety instructions!



Not permitted for wet grinding!



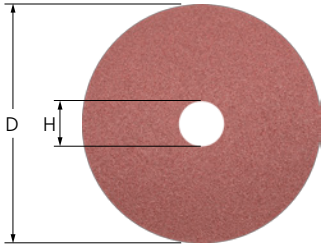

Aluminum oxide A

For universal grinding work from coarse to fine grinding in industry and professional trades.



Special features:

- High productivity due to long service life and very high stock removal rate.
- Consistent surface finish due to high-quality abrasives. Highly flexible, enabling optimal adjustment to the contour.
- Optimal adjustment to the contour in conjunction with the matching backing pad. Please order backing pad separately.

4

D [Inch]	H [Inch]	Abrasive	Grit size	Max. RPM		Item no.	EDP no.
4-1/2	7/8	A	16	13,300	25	69401036	62451
			24	13,300	25	69401017	62452
			36	13,300	25	69401035	62453
			50	13,300	25	69401066	62454
			60	13,300	25	69401011	62455
			80	13,300	25	69401034	62456
			100	13,300	25	69401028	62457
			120	13,300	25	69401084	62458
5	7/8	A	16	12,200	25	69401111	62501
			24	12,200	25	69401022	62502
			36	12,200	25	69401018	62503
			50	12,200	25	69401064	62504
			60	12,200	25	69401020	62505
			80	12,200	25	69401010	62506
			100	12,200	25	69401021	62507
			120	12,200	25	69401025	62508
7	7/8	A	16	8,500	25	69401029	62701
			24	8,500	25	69401004	62702
			36	8,500	25	69401005	62703
			50	8,500	25	69401039	62704
			60	8,500	25	69401001	62705
			80	8,500	25	69401006	62706

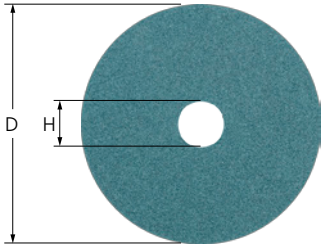

Zirconia alumina Z

For universal coarse grinding with high stock removal and long service life.

Special features:

- High productivity due to long service life and very high stock removal rate.
- Consistent surface finish due to high-quality abrasives. Highly flexible, enabling optimal adjustment to the contour.
- Optimal adjustment to the contour in conjunction with the matching backing pad. Please order backing pad separately.

D [Inch]	H [Inch]	Abrasive	Grit size	Max. RPM		Item no.	EDP no.
4-1/2	7/8	Z	24	13,300	25	69401138	62462
			36	13,300	25	69401143	62463
			50	13,300	25	69401130	62464
			60	13,300	25	69401146	62465
			80	13,300	25	69401131	62466
5	7/8	Z	24	12,200	25	69401075	62522
			36	12,200	25	69401145	62523
			50	12,200	25	69401079	62524
			60	12,200	25	69401080	62525
			80	12,200	25	69401081	62526
7	7/8	Z	24	8,500	25	69401147	62712
			36	8,500	25	69401048	62713
			50	8,500	25	69401148	62714
			60	8,500	25	69401073	62715
			80	8,500	25	69401149	62716

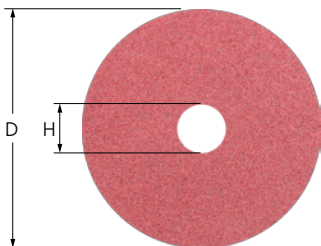

Ceramic oxide grain CO

For aggressive grinding with maximum stock removal; very long service life. Consistently high performance due to self-sharpening ceramic oxide grain, which is specifically designed for work on hard materials and layers.

Special features:

- High productivity due to long service life and very high stock removal rate.
- Consistent surface finish due to high-quality abrasives. Highly flexible, enabling optimal adjustment to the contour.
- Optimal adjustment to the contour in conjunction with the matching backing pad. Please order backing pad separately.

D [Inch]	H [Inch]	Abrasive	Grit size	Max. RPM		Item no.	EDP no.
4-1/2	7/8	CO	24	13,300	25	69401253	62410
			36	13,300	25	69401254	62411
			60	13,300	25	69401256	62413
			80	13,300	25	69401257	62414
5	7/8	CO	24	12,200	25	69401275	62510
			36	12,200	25	69401276	62511
7	7/8	CO	24	8,500	25	69401292	62743
			36	8,500	25	69401293	62744
			50	8,500	25	69401294	62745



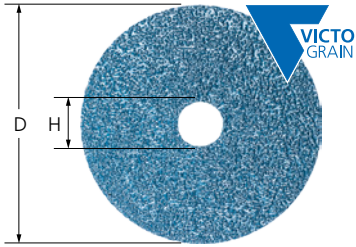

VICTOGRAIN®

For extremely aggressive grinding with an extremely high service life and an outstanding stock removal rate on steel and hard materials. Outstanding, constant high performance due to the VICTOGRAIN® abrasive grain.



Special features:

- High productivity due to long service life and very high stock removal rate.
- Consistent surface finish due to high-quality abrasives. Highly flexible, enabling optimal adjustment to the contour.
- Optimal adjustment to the contour in conjunction with the matching backing pad. Please order backing pad separately.



D [Inch]	H [Inch]	Abrasive	Grit size	Max. RPM		Item no.	EDP no.
4-1/2	7/8	VICTOGRAIN	60	13,300	25	69401661	40355
			80	13,300	25	69401662	40358
5	7/8	VICTOGRAIN	36	12,200	25	64279016	40337
			60	12,200	25	69401663	40356
			80	12,200	25	69401664	40359
7	7/8	VICTOGRAIN	60	8,500	25	69401665	40357
			80	8,500	25	69401666	40360

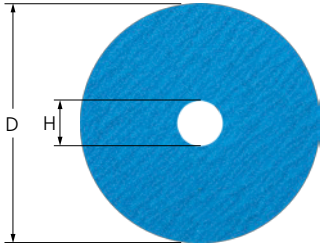

Zirconia alumina Z-COOL

For coarse grinding work with a high stock removal rate and cool grinding. Active grinding additives substantially improve the stock removal rate, prevent loading, and result in cooler grinding.

Special features:

- High productivity due to long service life and very high stock removal rate.
- Consistent surface finish due to high-quality abrasives. Highly flexible, enabling optimal adjustment to the contour.
- Optimal adjustment to the contour in conjunction with the matching backing pad. Please order backing pad separately.

D [Inch]	H [Inch]	Abrasive	Grit size	Max. RPM		Item no.	EDP no.
4-1/2	7/8	Z-COOL	36	13,300	25	69401113	62468
			50	13,300	25	69401114	62469
			60	13,300	25	69401164	62470
5	7/8	Z-COOL	36	12,200	25	69401118	62528
			60	12,200	25	69401120	62530
			80	12,200	25	69401121	62531
7	7/8	Z-COOL	36	8,500	25	69401123	62718
			50	8,500	25	69401124	62719
			60	8,500	25	69401125	62720
			80	8,500	25	69401126	62721

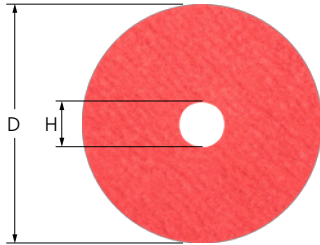

Ceramic oxide grain CO-COOL

Consistently high performance and aggressive grinding due to self-sharpening ceramic oxide grain. Active grinding additives improve the stock removal rate, prevent clogging and result in cooler grinding on hard materials which do not conduct heat well.



Special features:

- High productivity due to long service life and very high stock removal rate.
- Consistent surface finish due to high-quality abrasives. Highly flexible, enabling optimal adjustment to the contour.
- Optimal adjustment to the contour in conjunction with the matching backing pad. Please order backing pad separately.

D [Inch]	H [Inch]	Abrasive	Grit size	Max. RPM		Item no.	EDP no.
4-1/2	7/8	CO-COOL	24	13,300	25	69401259	62416
			36	13,300	25	69401203	62417
			50	13,300	25	69401261	62418
			60	13,300	25	69401262	62419
			80	13,300	25	69401263	62420
			120	13,300	25	69401264	62421
5	7/8	CO-COOL	24	12,200	25	69401281	62516
			36	12,200	25	69401282	62517
			50	12,200	25	69401283	62518
			60	12,200	25	69401284	62519
			80	12,200	25	69401285	62520
			120	12,200	25	69401286	62521
7	7/8	CO-COOL	24	8,500	25	69401298	62749
			36	8,500	25	69401299	62750
			50	8,500	25	69401300	62751
			60	8,500	25	69401301	62752
			80	8,500	25	69401302	62753
			120	8,500	25	69401303	62754



Fibre discs

Fibre discs

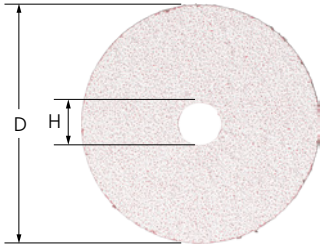

Ceramic oxide grain CO-ALU

For aggressive grinding with maximum stock removal rate for machining non-ferrous metals. Consistently high performance due to self-sharpening ceramic oxide grain. Adhesion-reducing additives in the coating significantly reduce the chip adhesion and therefore reduce loading of the fibre discs.



Special features:

- High productivity due to long service life and very high stock removal rate.
- Consistent surface finish due to high-quality abrasives. Highly flexible, enabling optimal adjustment to the contour.
- Optimal adjustment to the contour in conjunction with the matching backing pad. Please order backing pad separately.

4

D [Inch]	H [Inch]	Abrasive	Grit size	Max. RPM		Item no.	EDP no.
4-1/2	7/8	CO-ALU	36	13,300	25	64282136	40771
			60	13,300	25	64282160	40772
			80	13,300	25	64282180	40773
5	7/8	CO-ALU	36	12,200	25	64282236	40774
			60	12,200	25	64282260	40775
			80	12,200	25	64282280	40776
7	7/8	CO-ALU	36	8,500	25	64282836	40777
			60	8,500	25	64282860	40778
			80	8,500	25	64282880	40779

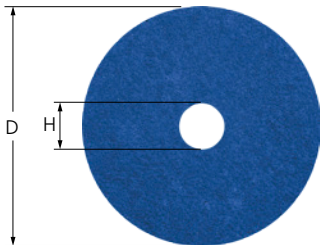

VICTOGRAIN®-COOL

For maximum removal rates with an extremely long service life on steel and materials which are hard or have poor heat-conducting properties. Active grinding additives in the coating substantially improve the stock removal rate, prevent loading and result in cooler grinding.

Special features:

- High productivity due to long service life and very high stock removal rate.
- Consistent surface finish due to high-quality abrasives. Highly flexible, enabling optimal adjustment to the contour.
- Optimal adjustment to the contour in conjunction with the matching backing pad. Please order backing pad separately.

D [Inch]	H [Inch]	Abrasive	Grit size	Max. RPM		Item no.	EDP no.
4-1/2	7/8	VICTOGRAIN-COOL	36	10,500	25	69401649	40340
			60	10,500	25	69401667	40343
			80	10,500	25	69401668	40346
5	7/8	VICTOGRAIN-COOL	36	9,650	25	69401650	40341
			60	9,650	25	69401669	40344
			80	9,650	25	69401670	40347
7	7/8	VICTOGRAIN-COOL	36	8,500	25	69401651	40342
			60	8,500	25	69401671	40345
			80	8,500	25	69401672	40348



Rubber backing pads

Backing pad for fibre discs for optimum adaptation to contours due to high flexibility. Complies with ISO 15636.

Special features:

- Backing pads for fibre discs used on commercially available angle grinders.

Suitable for tool diameter [Inch]	Thread	Version	Suitable for machine types	Max. RPM		Item no.	EDP no.
4 1/2	5/8-11	M (medium)	Angle grinders 4-1/2" / 5", spindle 5/8-11"	13,300	1	67901008	69455
5	5/8-11	M (medium)	Angle grinders 5", spindle 5/8-11"	12,200	1	84900046	69525
7	5/8-11	W (soft)	Angle grinders 7", spindle 5/8-11"	10,200	1	84900048	69704
		M (medium)	Angle grinders 7", spindle 5/8-11"	8,500	1	84900049	69705
		H (hard)	Angle grinders 7", spindle 5/8-11"	8,500	1	84900050	69706



High-performance backing pads

High-performance backing pad for fibre discs with a long service life due to abrasion-resistant, fibreglass-reinforced plastic. Particularly cool grinding due to radially arranged cooling fins, and high fibre-disc stock removal rate due to sturdy, rigid design.

Special features:

- Backing pads for fibre discs used on commercially available angle grinders.

Suitable for tool diameter [Inch]	Thread	Suitable for machine types	Max. RPM		Item no.	EDP no.
4 1/2	5/8-11	Angle grinders 4-1/2" / 5", spindle 5/8"	13,300	1	47601221	69481
5	5/8-11	Angle grinders 5", spindle 5/8-11"	12,200	1	47601222	69484
7	5/8-11	Angle grinders 7", spindle 5/8-11"	8,500	1	47601122	69487



Temperature-resistant backing pads

Temperature-resistant backing pad with a long service life due to the highly temperature-resistant material. High-precision work with flexible density. Maximum stock removal with hard density.

Special features:

- Backing pads for fibre discs used on commercially available angle grinders.

Suitable for tool diameter [Inch]	Thread	Version	Suitable for machine types	Max. RPM		Item no.	EDP no.
4 1/2	5/8-11	(F) Flexible	Angle grinders 4-1/2" / 5", spindle 5/8-11"	13,300	1	47601211	69480
		H (hard)	Angle grinders 4-1/2" / 5", spindle 5/8-11"	13,300	1	47601593	69482
5	5/8-11	(F) Flexible	Angle grinders 5", spindle 5/8-11"	12,200	1	47601212	69483
		H (hard)	Angle grinders 5", spindle 5/8-11"	12,200	1	47601594	69485
7	5/8-11	(F) Flexible	Angle grinders 7", spindle 5/8-11"	8,500	1	47601213	69486
		H (hard)	Angle grinders 7", spindle 5/8-11"	8,500	1	47601595	69488



Fibre discs

Backing pad

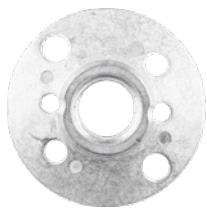

Fibre disc backing pad accessories

Fibre disc backing pad accessories, including clamping nuts and spanner wrench.

Special features:

- Matching center hole distances for standard commercial spanner wrench.

Thread	Suitable for machine types		Item no.	EDP no.
5/8-11	Angle grinder 4-1/2" / 5", spindle 5/8"-11	1	84900020	69107
	Angle grinder 7" – 9", spindle 5/8"-11	1	84900022	69108
	Angle grinder 4-1/2" – 7", spindle 5/8"-11	1	47601220	42071

4



Spanner wrench

Face pin spanner (STL) for securely fastening clamping flanges.

Special features:

- Generally suitable for all clamping flanges.

- Offset face pin spanners for angle grinders.

	Item no.	EDP no.
1	84900027	69115

Stand



Fibre disc storage device

Fibre disc storage device made from impact-resistant plastic. Device helps maintain fibre disc shape and prevents curling. The storage device can be stood upright, as well as mounted to walls.

Special features:

- Excellent storage for fibre grinding discs.
- With quick adjustment device and attachment holes on the base.
- Suitable for fibre disc diameters of 4" to 9".

	Item no.	EDP no.
1	44858015	47245

Safety notes

- The maximum permitted peripheral speed is 5,000 SFPM.
- For safety reasons, the maximum permitted rotational speed indicated must never be exceeded.



Wear eye protection!



Wear hearing protection!



Wear gloves!



Wear a dust mask!



Follow the safety instructions!



PSA discs

4



Aluminum oxide A

For universal grinding work from coarse to fine grinding in industry and professional trades.



Special features:

- Conforms to contours due to high flexibility.
- Disc securely held on the holder with high-quality adhesive connection.
- Quick and easy product change. Please order abrasive disc holder separately.

D ₁ [Inch]	Abrasive	Grit size	Opt. RPM	Max. RPM		Item no.	EDP no.
5	A	36	4,600	4,850	50	47201683	47361
		40	4,600	4,850	50	47201684	47362
		50	4,600	4,850	50	47201685	47363
		60	4,600	4,850	50	47201686	47364
		80	4,600	4,850	50	47201687	47365
		100	4,600	4,850	50	47201688	47366
		120	4,600	4,850	50	47201689	47367
		150	4,600	4,850	50	47201690	47368
		180	4,600	4,850	50	47201691	47369
		220	4,600	4,850	50	47201692	47370
		240	4,600	4,850	50	47201693	47371
		320	4,600	4,850	50	47201694	47372
6	A	36	3,800	4,100	50	47201696	47374
		40	3,800	4,100	50	47201697	47375
		50	3,800	4,100	50	47201698	47376
		60	3,800	4,100	50	47201699	47377
		80	3,800	4,100	50	47201700	47378
		100	3,800	4,100	50	47201701	47379
		120	3,800	4,100	50	47201702	47380
		150	3,800	4,100	50	47201703	47381

Continued on next page

PSA discs

PSA discs



D ₁ [Inch]	Abrasive	Grit size	Opt. RPM	Max. RPM		Item no.	EDP no.
6	A	180	3,800	4,100	50	47201704	47382
		220	3,800	4,100	50	47201705	47383
		240	3,800	4,100	50	47201706	47384
		320	3,800	4,100	50	47201707	47385



Zirconia alumina Z

Designed for coarse grinding and high stock removal with a long service life.

Special features:

- Conforms to contours due to high flexibility.
- Disc securely held on the holder with high-quality adhesive connection.
- Quick and easy product change. Please order abrasive disc holder separately.

D ₁ [Inch]	Abrasive	Grit size	Opt. RPM	Max. RPM		Item no.	EDP no.
5	Z	36	4,600	4,850	50	47201802	47560
		40	4,600	4,850	50	47201803	47561
		60	4,600	4,850	50	47201805	47563
		80	4,600	4,850	50	47201806	47564
		120	4,600	4,850	50	47201808	47566
6	Z	36	3,800	4,100	50	47201809	47570
		40	3,800	4,100	50	47201810	47571
		60	3,800	4,100	50	47201812	47573
		80	3,800	4,100	50	47201813	47574
		120	3,800	4,100	50	47201815	47576

PSA disc holders

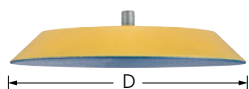

Threaded spindle

Backing pad for use with PSA discs. For threaded spindle (dual action machines).

Special features:

- Conforms to contours due to high flexibility.
- High-quality adhesive keeps disc secured to holder.
- Quick and easy product change.

D [Inch]	Thread	Max. RPM		Item no.	EDP no.
5	5/16-24	10,000	1	47601089	47266
6	5/16-24	10,000	1	47601090	47268

COMBIDISC® attachment system CD and CDR

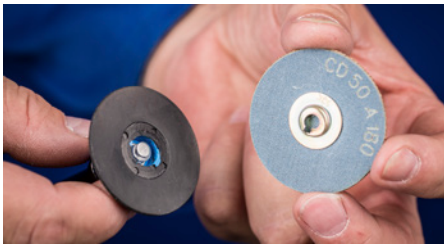

CD system

Disc side: Threaded connection with female thread (metal/plastic)

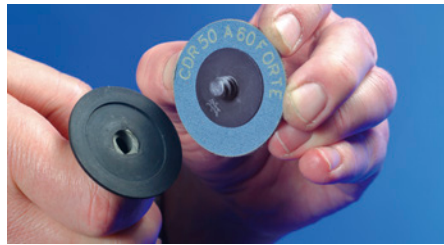

CDR system

Disc side: Threaded connection with male thread (plastic)



Quick product selection guide

Material group ▼		Abrasive ▶	Aluminum oxide A, A-PLUS, A-CONTOUR	Aluminum oxide A, compact grain	Zirconia alumina Z	Silicon carbide SiC	Aluminum oxide A-COOL	Ceramic oxide grain CO-COOL	VICTOGRAIN® -COOL	Abrasive discs Diamond	POLICLEAN® discs	Non-woven discs Soft type, Hard type, Unitized
Steel, cast steel	Non-hardened, non-heat-treated steels	Construction steels, carbon steels, tool steels, non-alloyed steels, cast steel	•		○			•	•		•	•
	Hardened, heat-treated steels	Tool steels, tempering steels, alloyed steels, cast steel	○	•	•			•	•		○	○
Stainless steel (INOX)	Rust and acid-resistant steels	Austenitic and ferritic stainless steels		•	○		•	•	•		•	•
Non-ferrous metals	Soft non-ferrous metals, non-ferrous metals	Soft aluminum alloys	○				•	○			•	•
		Brass, copper, zinc	•		○						•	•
	Hard non-ferrous metals	Hard aluminum alloys	•		○	○					•	•
		Bronze, titanium			○	•		•	•	•	○	•
	High-temperature-resistant materials	Nickel-based and cobalt-based alloys			○		•	•	•	○	•	
Cast iron	Grey cast iron, white cast iron	Cast iron with flake graphite, with nodular graphite/nodular cast iron, white annealed cast iron, black annealed cast iron	•		○						•	•
Plastics, other materials		Fibre-reinforced plastics, thermoplastics, wood, chipboard, paint	•			•				•	•	•

• = highly recommended ○ = recommended

Safety notes

- The maximum permitted peripheral speed is 9,800 SFPM.
- For safety reasons, the maximum permitted rotational speed indicated must never be exceeded.



Wear eye protection!



Wear hearing protection!



Wear gloves!



Wear a dust mask!



Follow the safety instructions!



4

Mini-POLIFAN® CD, CDR

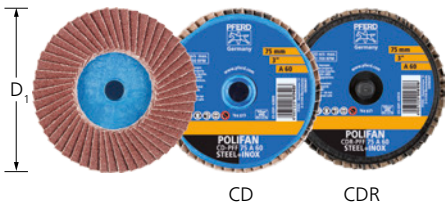



Aluminum oxide A

For universal coarse grinding work with high stock removal rates. Ideal for dressing weld seams in hard-to-reach places. Longer service life and higher stock removal rate when compared to abrasive discs.



Special features:

- Convenient to use due to simple handling and low-vibration working.
- No operational disruptions caused by sticking, slipping, or disengaging.
- Highly cost-effective as product can be changed quickly with innovative COMBIDISC® clamping system. Please order abrasive disc holder separately.

D ₁ [Inch]	Abrasive	Grit size	Opt. RPM		Item no.	EDP no.
CD system 						
2	A	40	12,000 – 14,000	10	42719104	42802
		60	12,000 – 14,000	10	42719106	42803
		80	12,000 – 14,000	10	42719108	42804
		120	12,000 – 14,000	10	42719112	42805
3	A	40	8,000 – 10,000	10	42719204	42808
		60	8,000 – 10,000	10	42719206	42809
		80	8,000 – 10,000	10	42719208	42810
		120	8,000 – 10,000	10	42719212	42811
CDR system 						
2	A	40	12,000 – 14,000	10	47202527	42912
		60	12,000 – 14,000	10	47202528	42913
		80	12,000 – 14,000	10	47202090	42914
		120	12,000 – 14,000	10	47202529	42915
3	A	40	8,000 – 10,000	10	47202530	42918
		60	8,000 – 10,000	10	47202531	42919
		80	8,000 – 10,000	10	47202091	42920
		120	8,000 – 10,000	10	47202532	42921

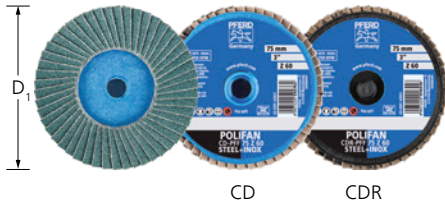

Zirconia alumina Z

For universal coarse grinding with high stock removal and long service life.



Special features:

- Convenient to use due to simple handling and low-vibration working.
- No operational disruptions caused by sticking, slipping, or disengaging.
- Highly cost-effective as product can be changed quickly with innovative COMBIDISC® clamping system. Please order abrasive disc holder separately.

D ₁ [Inch]	Abrasive	Grit size	Opt. RPM		Item no.	EDP no.
CD system						
2	Z	40	12,000 – 14,000	10	42719504	42814
		60	12,000 – 14,000	10	42719506	42815
		80	12,000 – 14,000	10	42719508	42816
		120	12,000 – 14,000	10	42719512	42817
3	Z	40	8,000 – 10,000	10	42719704	42820
		60	8,000 – 10,000	10	42719706	42821
		80	8,000 – 10,000	10	42719708	42822
		120	8,000 – 10,000	10	42719712	42823
CDR system						
2	Z	40	12,000 – 14,000	10	47202125	42924
		60	12,000 – 14,000	10	47202126	42925
		80	12,000 – 14,000	10	47202533	42926
		120	12,000 – 14,000	10	47202534	42927
3	Z	40	8,000 – 10,000	10	47202101	42930
		60	8,000 – 10,000	10	47202535	42931
		80	8,000 – 10,000	10	47202536	42932
		120	8,000 – 10,000	10	47202092	42933

Drive arbors

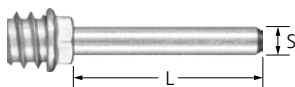

Drive arbors for Mini-POLIFAN® discs

Matching arbor for use with COMBIDISC® Mini-POLIFAN® discs with CD thread.

S [Inch]	L [Inch]	Suitable for		Item no.	EDP no.
1/4	1-1/2	for 2" Discs	1	47601160	42851
		for 3" Discs	1	47601078	42852



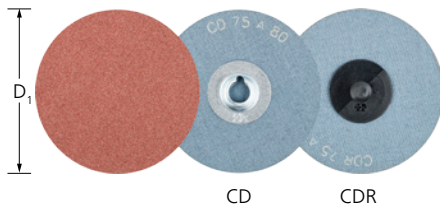



Aluminum oxide A

For universal coarse to fine grinding applications in industry and professional trades.



Special features:

- Convenient to use due to simple handling and low-vibration working.
- No operational disruptions caused by sticking, slipping, or disengaging.
- Highly cost-effective as product can be changed quickly with innovative COMBIDISC® clamping system. Please order abrasive disc holder separately.

D ₁ [Inch]	Abrasive	Grit size	Opt. RPM		Item no.	EDP no.		
CD system 								
1	A	60	15,000 – 26,000	100	42750306	42136		
		80	15,000 – 26,000	100	42750308	42137		
		120	15,000 – 26,000	100	42750312	42139		
		180	15,000 – 26,000	100	42750318	42141		
		320	15,000 – 26,000	100	42750332	42143		
1-1/2	A	36	10,000 – 16,000	100	42750403	42145		
		60	10,000 – 16,000	100	42750406	42148		
		80	10,000 – 16,000	100	42750408	42149		
		120	10,000 – 16,000	100	42750412	42151		
		320	10,000 – 16,000	100	42750432	42155		
2	A	36	8,000 – 13,000	100	42750503	42157		
		50	8,000 – 13,000	100	47201084	42159		
		60	8,000 – 13,000	100	42750506	42160		
		80	8,000 – 13,000	100	42750508	42161		
		120	8,000 – 13,000	100	42750512	42163		
		180	8,000 – 13,000	100	42750518	42165		
3	A	320	8,000 – 13,000	100	42750532	42167		
		36	5,000 – 9,000	50	42750703	42169		
		50	5,000 – 9,000	50	47201181	42171		
		60	5,000 – 9,000	50	42750706	42172		
		80	5,000 – 9,000	50	42750708	42173		
		120	5,000 – 9,000	50	42750712	42175		
1-1/2	A	180	5,000 – 9,000	50	42750718	42177		
		320	5,000 – 9,000	50	42750732	42179		
		CDR system 						
		1	A	60	15,000 – 26,000	100	42770306	42481
				80	15,000 – 26,000	100	42770308	42482
				120	15,000 – 26,000	100	42770312	42484
180	15,000 – 26,000			100	42770318	42486		
1-1/2	A	36	10,000 – 16,000	100	42770403	42490		
		60	10,000 – 16,000	100	42770406	42493		
		80	10,000 – 16,000	100	42770408	42494		
		120	10,000 – 16,000	100	42770412	42496		
		180	10,000 – 16,000	100	42770418	42498		
		320	10,000 – 16,000	100	42770432	42500		
2	A	36	8,000 – 13,000	100	42770503	42502		

Continued on next page

D ₁ [Inch]	Abrasive	Grit size	Opt. RPM		Item no.	EDP no.
2	A	50	8,000 – 13,000	100	47201280	42504
		60	8,000 – 13,000	100	42770506	42505
		80	8,000 – 13,000	100	42770508	42506
		120	8,000 – 13,000	100	42770512	42508
		180	8,000 – 13,000	100	42770518	42510
		320	8,000 – 13,000	100	42770532	42512
3	A	36	5,000 – 9,000	50	42770703	42514
		50	5,000 – 9,000	50	47201286	42516
		60	5,000 – 9,000	50	42770706	42517
		80	5,000 – 9,000	50	42770708	42518
		120	5,000 – 9,000	50	42770712	42520
		180	5,000 – 9,000	50	42770718	42522
		320	5,000 – 9,000	50	42770732	42524

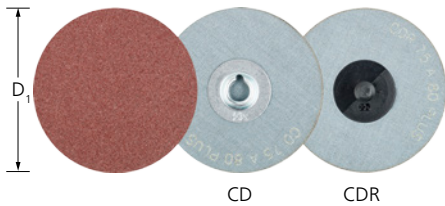



Aluminum oxide A-PLUS

For universal applications from coarse to fine grinding. Higher stock removal rate due to sturdy backing material. Excellent for edge grinding due to high tear strength.

Special features:

- Convenient to use due to simple handling and low-vibration working.
- No operational disruptions caused by sticking, slipping, or disengaging.
- Highly cost-effective as product can be changed quickly with innovative COMBIDISC® clamping system. Please order abrasive disc holder separately.

D ₁ [Inch]	Abrasive	Grit size	Opt. RPM		Item no.	EDP no.
CD system 						
2	A-PLUS	36	8,000 – 13,000	100	42755503	42330
		60	8,000 – 13,000	100	42755506	42331
		80	8,000 – 13,000	100	42755508	42332
		120	8,000 – 13,000	100	42755512	42333
3	A-PLUS	36	5,000 – 9,000	50	42755703	42335
		60	5,000 – 9,000	50	42755706	42336
		80	5,000 – 9,000	50	42755708	42337
		120	5,000 – 9,000	50	42755712	42338
CDR system 						
2	A-PLUS	36	8,000 – 13,000	100	42775503	42670
		60	8,000 – 13,000	100	42775506	42671
		80	8,000 – 13,000	100	42775508	42672
		120	8,000 – 13,000	100	42775512	42673
3	A-PLUS	36	5,000 – 9,000	50	42775703	42675
		60	5,000 – 9,000	50	42775706	42676
		80	5,000 – 9,000	50	42775708	42677
		120	5,000 – 9,000	50	42775712	42678



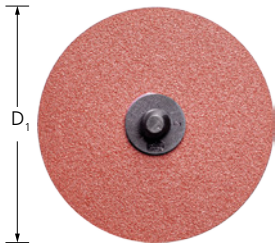



RS aluminum oxide A-PLUS

Outstandingly well suited for weld dressing of back-wards repair welds, e.g. in cases, slots and grooves on engines and for processing welded-on combustor plates.



Special features:

- Outstandingly well suited for weld dressing of back-wards repair welds, e.g. in cases, slots and grooves on engines and for processing welded-on combustor plates.
- Unlike on conventional abrasive discs, the abrasive coating is on the underside of the product which allows backwards working in hard-to-reach areas.
- Please order backing pad separately

D ₁ [Inch]	Abrasive	Grit size	Opt. RPM		Item no.	EDP no.
CDR system 						
1-1/2	A-PLUS	60	10,000 – 16,000	100	42799025	40600
		80	10,000 – 16,000	100	42799026	40601
		120	10,000 – 16,000	100	42799027	40602
2	A-PLUS	60	8,000 – 13,000	100	42799028	40603
		80	8,000 – 13,000	100	42799029	40604
		120	8,000 – 13,000	100	42799030	40605
3	A-PLUS	60	5,000 – 9,000	50	42799031	40606
		80	5,000 – 9,000	50	42799032	40607
		120	5,000 – 9,000	50	42799033	40608"

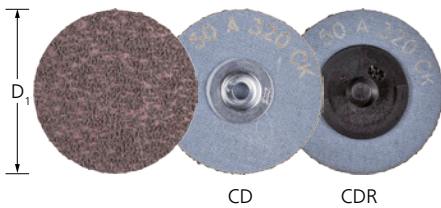



Aluminum oxide A compact grain

Extremely well suited to fine and very fine grinding, and for step-by-step preparations for polishing. The self-sharpening compact grain facilitates a very long service life and achieves consistent surface quality levels throughout the entire service life.

Special features:

- Convenient to use due to simple handling and low-vibration working.
- No operational disruptions caused by sticking, slipping, or disengaging.
- Please order backing pad separately

D ₁ [Inch]	Abrasive	Grit size	Opt. RPM		Item no.	EDP no.
CD system 						
2	A-CK	120	3,800 – 13,000	100	42755012	42936
		180	3,800 – 13,000	100	42755018	42937
		240	3,800 – 13,000	100	42755024	42938
		320	3,800 – 13,000	100	42755032	42939
		400	3,800 – 13,000	100	42755040	42940
		600	3,800 – 13,000	100	42755060	42941
		800	3,800 – 13,000	100	42755080	42942
		1000	3,800 – 13,000	100	42755100	42943
		1200	3,800 – 13,000	100	42755120	42944
3	A-CK	120	2,500 – 9,000	50	42757012	42945
		180	2,500 – 9,000	50	42757018	42946
		240	2,500 – 9,000	50	42757024	42947
		320	2,500 – 9,000	50	42757032	42948
		400	2,500 – 9,000	50	42757040	42949

Continued on next page

D ₁ [Inch]	Abrasive	Grit size	Opt. RPM		Item no.	EDP no.
3	A-CK	600	2,500 – 9,000	50	42757060	42950
		800	2,500 – 9,000	50	42757080	42951
		1000	2,500 – 9,000	50	42757100	42952
		1200	2,500 – 9,000	50	42757120	42953
CDR system						
2	A-CK	120	3,800 – 13,000	100	42795012	42954
		180	3,800 – 13,000	100	42795018	42955
		240	3,800 – 13,000	100	42795024	42956
		320	3,800 – 13,000	100	42795032	42957
		400	3,800 – 13,000	100	42795040	42958
		600	3,800 – 13,000	100	42795060	42959
		800	3,800 – 13,000	100	42795080	42960
		1000	3,800 – 13,000	100	42795100	42961
		1200	3,800 – 13,000	100	42795120	42962
3	A-CK	120	2,500 – 9,000	50	42797012	42963
		180	2,500 – 9,000	50	42797018	42964
		240	2,500 – 9,000	50	42797024	42965
		320	2,500 – 9,000	50	42797032	42966
		400	2,500 – 9,000	50	42797040	42967
		600	2,500 – 9,000	50	42797060	42968
		800	2,500 – 9,000	50	42797080	42969
		1000	2,500 – 9,000	50	42797100	42970
		1200	2,500 – 9,000	50	42797120	42971

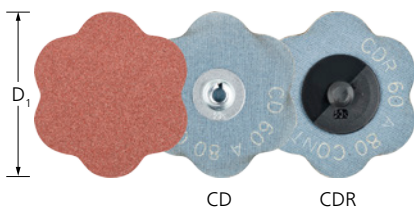

Aluminum oxide A-CONTOUR

Very flexible and adaptable due to scalloped-edge outer contour shape. Helps prevent cutting into the workpiece.



Special features:

- Convenient to use due to simple handling and low-vibration working.
- No operational disruptions caused by sticking, slipping, or disengaging.
- Highly cost-effective as product can be changed quickly with innovative COMBIDISC® clamping system. Please order abrasive disc holder separately.

D ₁ [Inch]	Abrasive	Grit size	Opt. RPM		Item no.	EDP no.
CD system						
2-3/8	A	60 CONTOUR	7,500 – 11,000	50	42759001	42117
		80 CONTOUR	7,500 – 11,000	50	42759002	42118
		120 CONTOUR	7,500 – 11,000	50	42759003	42119
		180 CONTOUR	7,500 – 11,000	50	42759004	42120
CDR system						
2-3/8	A	60 CONTOUR	7,500 – 11,000	50	42759005	42425
		80 CONTOUR	7,500 – 11,000	50	42759006	42426
		120 CONTOUR	7,500 – 11,000	50	42759007	42427
		180 CONTOUR	7,500 – 11,000	50	42759008	42428

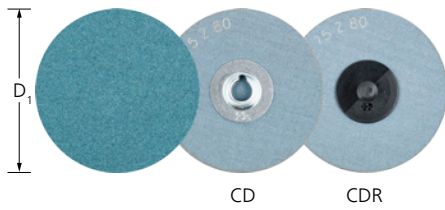



Zirconia alumina Z

For coarse grinding work with a high stock removal rate and a long service life. High stock removal rate in coarse grinding applications using grit sizes 36 and 60.



Special features:

- Convenient to use due to simple handling and low-vibration working.
- No operational disruptions caused by sticking, slipping, or disengaging.
- Highly cost-effective as product can be changed quickly with innovative COMBIDISC® clamping system. Please order abrasive disc holder separately.

D ₁ [Inch]	Abrasive	Grit size	Opt. RPM		Item no.	EDP no.
CD system 						
2	Z	36	3,800 – 13,000	100	42753503	42254
		50	3,800 – 13,000	100	47201220	42256
		60	3,800 – 13,000	100	42753506	42257
		80	3,800 – 13,000	100	42753508	42258
3	Z	36	2,500 – 9,000	50	42753703	42261
		50	2,500 – 9,000	50	47201224	42263
		60	2,500 – 9,000	50	42753706	42264
		80	2,500 – 9,000	50	42753708	42265
CDR system 						
2	Z	36	3,800 – 13,000	100	42773503	42593
		50	3,800 – 13,000	100	47201328	42595
		60	3,800 – 13,000	100	42773506	42596
		80	3,800 – 13,000	100	42773508	42597
3	Z	36	2,500 – 9,000	50	42773703	42600
		50	2,500 – 9,000	50	47201332	42602
		60	2,500 – 9,000	50	42773706	42603
		80	2,500 – 9,000	50	42773708	42604

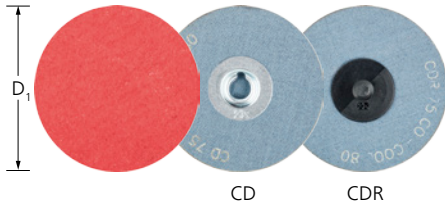

Ceramic oxide grain CO-COOL

Consistently high performance and aggressive grinding due to self-sharpening ceramic oxide grain. Active grinding additives improve the stock removal rate, prevent clogging and result in cooler grinding on hard materials which do not conduct heat well.



Special features:

- Convenient to use due to simple handling and low-vibration working.
- No operational disruptions caused by sticking, slipping, or disengaging.
- Highly cost-effective as product can be changed quickly with innovative COMBIDISC® clamping system. Please order abrasive disc holder separately.

D ₁ [Inch]	Abrasive	Grit size	Opt. RPM		Item no.	EDP no.
CD system						
2	CO-COOL	24	3,800 – 13,000	100	42756502	42280
		36	3,800 – 13,000	100	42756503	42289
		60	3,800 – 13,000	100	42756506	42292
		80	3,800 – 13,000	100	42756508	42293
		120	3,800 – 13,000	100	42756512	42295
3	CO-COOL	24	2,500 – 9,000	50	42756702	42281
		36	2,500 – 9,000	50	42756703	42296
		60	2,500 – 9,000	50	42756706	42299
		80	2,500 – 9,000	50	42756708	42300
		120	2,500 – 9,000	50	42756712	42302
CDR system						
2	CO-COOL	24	3,800 – 13,000	100	42776502	42619
		36	3,800 – 13,000	100	42776503	42628
		60	3,800 – 13,000	100	42776506	42631
		80	3,800 – 13,000	100	42776508	42632
		120	3,800 – 13,000	100	42776512	42634
3	CO-COOL	24	2,500 – 9,000	50	42776702	42620
		36	2,500 – 9,000	50	42776703	42635
		60	2,500 – 9,000	50	42776706	42638
		80	2,500 – 9,000	50	42776708	42639
		120	2,500 – 9,000	50	42776712	42641

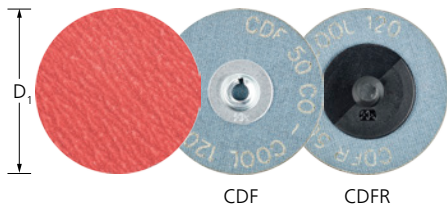

Ceramic oxide grain CO-COOL mini fibre discs

Consistently high performance and aggressive grinding due to self-sharpening ceramic oxide grain. Active grinding additives improve the stock removal rate, prevent clogging and result in cooler grinding on hard materials which do not conduct heat well.

Special features:

- Well-suited for surface and edge grinding. The fibre backing considerably strengthens the abrasive disc and improves stock removal.
- High economic efficiency as disc can be changed quickly. Very comfortable due to ease of use and low-vibration working.
- Please order arbors or disc backing pads separately.

D ₁ [Inch]	Abrasive	Grit size	Opt. RPM		Item no.	EDP no.
CD system						
2	CO-COOL	36	3,800 – 13,000	100	42749503	40492
		50	3,800 – 13,000	100	42749505	40494
		80	3,800 – 13,000	100	42749508	40496
		120	3,800 – 13,000	100	42749512	40497
3	CO-COOL	36	2,500 – 9,000	50	42749703	40499
		50	2,500 – 9,000	50	42749705	40501
		80	2,500 – 9,000	50	42749708	40503
		120	2,500 – 9,000	50	42749712	40504
CDR system						
2	CO-COOL	36	3,800 – 13,000	100	42778503	40632
		50	3,800 – 13,000	100	42778505	40634
		80	3,800 – 13,000	100	42778508	40636
		120	3,800 – 13,000	100	42778512	40637
3	CO-COOL	36	2,500 – 9,000	50	42778703	40639
		50	2,500 – 9,000	50	42778705	40641
		80	2,500 – 9,000	50	42778708	40643
		120	2,500 – 9,000	50	42778712	40644

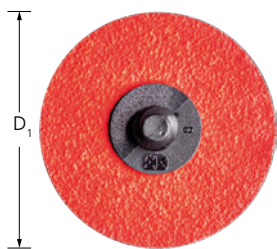

RS ceramic oxide grain CO-COOL mini fibre disc

Consistently high performance and aggressive grinding due to self-sharpening ceramic oxide grain. Active grinding additives improve the stock removal rate, prevent clogging and result in cooler grinding on hard materials which do not conduct heat well.



Special features:

- Outstandingly well suited for weld dressing of back-wards repair welds, e.g. in cases, slots and grooves on engines and for processing welded-on combustor plates.
- Unlike on conventional abrasive discs, the abrasive coating is on the underside of the product which allows backwards working in hard-to-reach areas.
- Please order backing pad separately

D ₁ [Inch]	Abrasive	Grit size	Opt. RPM		Item no.	EDP no.
CDR system						
1-1/2	CO-COOL	50	10,000 – 16,000	100	42799010	40570
		80	10,000 – 16,000	100	47201013	40571
		120	10,000 – 16,000	100	42799011	40572
2	CO-COOL	50	3,800 – 13,000	100	42799012	40573

Continued on next page

D ₁ [Inch]	Abrasive	Grit size	Opt. RPM		Item no.	EDP no.
2	CO-COOL	80	3,800 – 13,000	100	47201007	40574
		120	3,800 – 13,000	100	42799013	40575
3	CO-COOL	50	2,500 – 9,000	50	42799014	40576
		80	2,500 – 9,000	50	47201014	40577
		120	2,500 – 9,000	50	42799015	40578

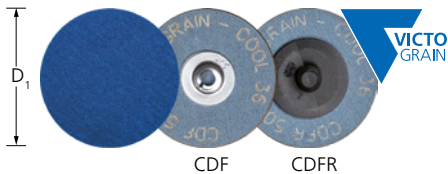



VICTOGRAIN®-COOL midget fibre discs

For maximum removal rates with an extremely long service life on steel and materials which are hard or have poor heat-conducting properties. Active grinding additives in the coating substantially improve the stock removal rate, prevent loading and result in cooler grinding.

Special features:

- Well-suited for surface and edge grinding. The fibre backing considerably strengthens the abrasive disc and improves stock removal.
- High economic efficiency as disc can be changed quickly. Very comfortable due to ease of use and low-vibration working.
- Please order arbors or disc backing pads separately.

D ₁ [Inch]	Abrasive	Grit size	Opt. RPM		Item no.	EDP no.
CD system						
2	VICTOGRAIN-COOL	36	3,800 – 13,000	100	42705036	42433
		60	3,800 – 13,000	100	42705060	42443
		80	3,800 – 13,000	100	42705080	42447
3	VICTOGRAIN-COOL	36	2,500 – 9,000	50	42707536	42434
		60	2,500 – 9,000	50	42707560	42444
		80	2,500 – 9,000	50	42707580	42448
CDR system						
2	VICTOGRAIN-COOL	36	3,800 – 13,000	100	42715036	42441
		60	3,800 – 13,000	100	42715060	42445
		80	3,800 – 13,000	100	42715080	42449
3	VICTOGRAIN-COOL	36	2,500 – 9,000	50	42717536	42442
		60	2,500 – 9,000	50	42717560	42446
		80	2,500 – 9,000	50	42717580	42450



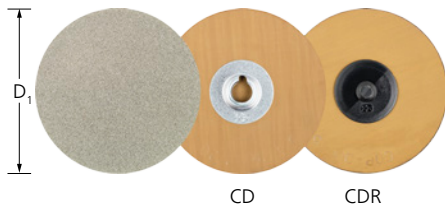



Diamond

Highly recommended for work on wear-resistant coatings and for hard facings made of tungsten carbide, chromium carbide, titanium carbide, etc. Recommended for work on materials used for aircraft engine construction, e.g. HASTELLOY®, INCONEL® and titanium/titanium alloys. Also highly recommended for work on extremely hard materials such as tungsten carbide, glass, ceramics, enamel, stone and carbon-reinforced plastic (CRP)/glass reinforced plastic (GRP).



Special features:

- High economic efficiency as disc can be changed quickly. Very comfortable due to ease of use and low-vibration working.
- Please order arbors or disc backing pads separately.
- The diamond grit sizes correspond to the following grit sizes according to ISO 6344: D 251 = P 60; D 126 = P 120; D 76 = P 220.

D ₁ [Inch]	Abrasive	Grit size [µm]	Opt. RPM		Item no.	EDP no.
CD system 						
1	DIA	251	7,500 – 15,000	10	42740001	40515
		126	7,500 – 15,000	10	42740002	40516
		76	7,500 – 15,000	10	42740003	40517
1-1/2	DIA	251	5,000 – 10,000	10	42740004	40518
		126	5,000 – 10,000	10	42740005	40519
		76	5,000 – 10,000	10	42740006	40520
2	DIA	251	3,800 – 7,500	10	42740007	40521
		126	3,800 – 7,500	10	42740008	40522
		76	3,800 – 7,500	10	42740009	40523
3	DIA	251	2,500 – 5,000	10	42740010	40524
		126	2,500 – 5,000	10	42740011	40525
		76	2,500 – 5,000	10	42740012	40526
CDR system 						
1	DIA	251	7,500 – 15,000	10	42758001	40655
		126	7,500 – 15,000	10	42758002	40656
1-1/2	DIA	251	5,000 – 10,000	10	42758004	40658
		76	5,000 – 10,000	10	42758006	40660
2	DIA	251	3,800 – 7,500	10	42758007	40661
		126	3,800 – 7,500	10	42758008	40662
		76	3,800 – 7,500	10	42758009	40663
3	DIA	126	2,500 – 5,000	10	42758011	40665
		76	2,500 – 5,000	10	42758012	40666

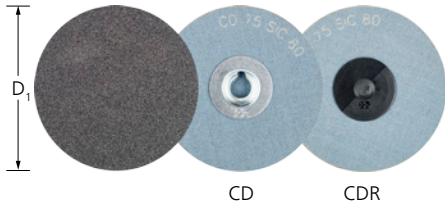

Silicon carbide SiC

For universal grinding work on components made from aluminum, copper, bronze, titanium and fibre-reinforced plastics. Particularly recommended for use on titanium alloys. Ideally suited to use in the aeronautical industry, especially where SiC is the only approved abrasive, e.g. for use on engine components.



Special features:

- Convenient to use due to simple handling and low-vibration working.
- No operational disruptions caused by sticking, slipping, or disengaging.
- Highly cost-effective as product can be changed quickly with innovative COMBIDISC® clamping system. Please order abrasive disc holder separately.

D ₁ [Inch]	Abrasive	Grit size	Opt. RPM		Item no.	EDP no.
CD system						
2	SiC	36	3,800 – 13,000	100	42754503	42415
		60	3,800 – 13,000	100	42754506	42416
		80	3,800 – 13,000	100	42754508	42417
		120	3,800 – 13,000	100	42754512	42418
		240	3,800 – 13,000	100	42754524	42419
3	SiC	36	2,500 – 9,000	50	42754703	42420
		60	2,500 – 9,000	50	42754706	42421
		80	2,500 – 9,000	50	42754708	42422
		120	2,500 – 9,000	50	42754712	42423
		240	2,500 – 9,000	50	42754724	42424
CDR system						
2	SiC	36	3,800 – 13,000	100	42774503	42750
		60	3,800 – 13,000	100	42774506	42751
		80	3,800 – 13,000	100	42774508	42752
		120	3,800 – 13,000	100	42774512	42753
		240	3,800 – 13,000	100	42774524	42754
3	SiC	36	2,500 – 9,000	50	42774703	42755
		60	2,500 – 9,000	50	42774706	42756
		80	2,500 – 9,000	50	42774708	42757
		120	2,500 – 9,000	50	42774712	42758
		240	2,500 – 9,000	50	42774724	42759

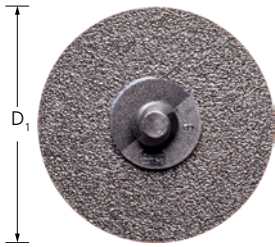



RS silicon carbide SiC

For universal grinding work on components made from aluminum, copper, bronze, titanium and fibre-reinforced plastics. Particularly recommended for use on titanium alloys. Ideally suited to use in the aeronautical industry, especially where SiC is the only approved abrasive, e.g. for use on engine components.



Special features:

- Outstandingly well suited for weld dressing of back-wards repair welds, e.g. in cases, slots and grooves on engines and for processing welded-on combustor plates.
- Unlike on conventional abrasive discs, the abrasive coating is on the underside of the product which allows backwards working in hard-to-reach areas.
- Please order backing pad separately

D ₁ [Inch]	Abrasive	Grit size	Opt. RPM		Item no.	EDP no.
CDR system 						
1-1/2	SiC	60	10,000 – 16,000	100	42799016	40585
		80	10,000 – 16,000	100	42799017	40586
		120	10,000 – 16,000	100	42799018	40587
2	SiC	60	3,800 – 13,000	100	42799019	40588
		80	3,800 – 13,000	100	42799020	40589
		120	3,800 – 13,000	100	42799021	40590
3	SiC	60	2,500 – 9,000	50	42799022	40591
		80	2,500 – 9,000	50	42799023	40592
		120	2,500 – 9,000	50	42799024	40593

POLICLEAN® discs CD, CDR

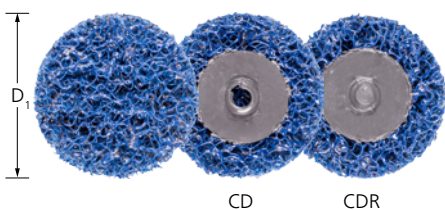



POLICLEAN® PLUS discs

For coarse cleaning work such as removing paint, scale, heat discoloration, rust and adhesive residues in face-down grinding. POLICLEAN® PLUS discs exhibit a higher stock removal rate with a very long service life.

Special features:

- Convenient to use due to simple handling and low-vibration working.
- No operational disruptions caused by sticking, slipping, or disengaging.
- Highly cost-effective as product can be changed quickly with innovative COMBIDISC® clamping system. Please order abrasive disc holder separately.

D ₁ [Inch]	Version	Abrasive	Opt. RPM		Item no.	EDP no.
CD system 						
2	PCLR PLUS	A	5,500 – 8,000	10	42780051	44840
3	PCLR PLUS	A	3,800 – 5,000	10	42780076	44841
CDR system 						
2	PCLR PLUS	A	5,500 – 8,000	10	42780052	44842
3	PCLR PLUS	A	3,800 – 5,000	10	42780077	44843

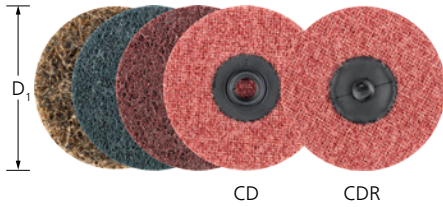



Surface conditioning, hard type

Designed for universal work on small and medium-sized metal surfaces, e.g. removing rough grinding traces, removing oxidation, and light deburring work. Achieve matte and satin-finished surfaces.



Special features:

- Convenient to use due to simple handling and low-vibration working.
- No operational disruptions caused by sticking, slipping, or disengaging.
- Highly cost-effective as product can be changed quickly with innovative COMBIDISC® clamping system. Please order abrasive disc holder separately.

D ₁ [Inch]	Abrasive	Grit size	Version	Opt. RPM		Item no.	EDP no.
CD system							
1-1/2	A	100 G	coarse, yellow-brown	7,000 – 10,000	50	47201919	43176
		180 M	medium, red-brown	7,000 – 10,000	50	47201920	43177
		240 F	fine, blue	7,000 – 10,000	50	47201921	43179
2	A	100 G	coarse, yellow-brown	5,500 – 7,500	50	47201797	43180
		180 M	medium, red-brown	5,500 – 7,500	50	47201798	43181
		240 F	fine, blue	5,500 – 7,500	50	47201799	43183
3	A	100 G	coarse, yellow-brown	3,800 – 5,000	25	47201922	43184
		180 M	medium, red-brown	3,800 – 5,000	25	47201923	43185
		240 F	fine, blue	3,800 – 5,000	25	47201924	43187
CDR system							
1-1/2	A	100 G	coarse, yellow-brown	7,000 – 10,000	50	47201925	43234
		180 M	medium, red-brown	7,000 – 10,000	50	47201926	43235
		240 F	fine, blue	7,000 – 10,000	50	47201927	43237
2	A	100 G	coarse, yellow-brown	5,500 – 7,500	50	47202021	43238
		180 M	medium, red-brown	5,500 – 7,500	50	47202022	43239
		240 F	fine, blue	5,500 – 7,500	50	47202023	43241
3	A	100 G	coarse, yellow-brown	3,800 – 5,000	25	47202024	43242
		180 M	medium, red-brown	3,800 – 5,000	25	47202025	43243
		240 F	fine, blue	3,800 – 5,000	25	47202026	43245
4	A	100 G	coarse, yellow-brown	2,850 – 4,000	25	47202033	43246
		180 M	medium, red-brown	2,850 – 4,000	25	47202134	43247
		240 F	fine, blue	2,850 – 4,000	25	47202162	43248



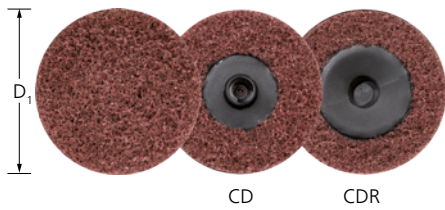



Finishing, Soft type

Designed for very fine grinding on small and medium-sized surfaces and contours, and for cleaning metal and painted surfaces. Achieve matte and satin-finished surfaces. Highly open structure.



Special features:

- Convenient to use due to simple handling and low-vibration working.
- No operational disruptions caused by sticking, slipping, or disengaging.
- Highly cost-effective as product can be changed quickly with innovative COMBIDISC® clamping system. Please order abrasive disc holder separately.

D ₁ [Inch]	Abrasive	Grit size	Version	Opt. RPM		Item no.	EDP no.
CD system 							
2	A	100	medium	5,500 – 7,500	50	42760502	43200
		180	fine	5,500 – 7,500	50	42760503	43201
		280	very fine	5,500 – 7,500	50	42760504	43203
3	A	100	medium	3,800 – 5,000	25	42760752	43204
		180	fine	3,800 – 5,000	25	42760753	43205
		280	very fine	3,800 – 5,000	25	42760754	43207
CDR system 							
2	A	100	medium	5,500 – 7,500	50	42780502	43258
		180	fine	5,500 – 7,500	50	42780503	43259
		280	very fine	5,500 – 7,500	50	42780504	43261
3	A	100	medium	3,800 – 5,000	25	42780752	43262
		180	fine	3,800 – 5,000	25	42780753	43263
		280	very fine	3,800 – 5,000	25	42780754	43265

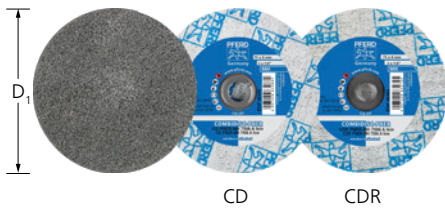



Unitized discs

For achieving a very fine, uniform surface finish which, depending on requirements, is a sufficient preparation for high-gloss polishing. Ideal for work on small and medium-sized surfaces of stainless steel (INOX) components.



Special features:

- Convenient to use due to simple handling and low-vibration working.
- No operational disruptions caused by sticking, slipping, or disengaging.
- Highly cost-effective as product can be changed quickly with innovative COMBIDISC® clamping system. Please order abrasive disc holder separately.

D ₁ [Inch]	Version	Abrasive	Grit size	Opt. RPM	Max. RPM		Item no.	EDP no.
CD system 								
2	W (soft)	A	G (coarse)	9,500	19,100	25	42759021	48431
		SiC	F (fine)	9,500	19,100	25	42759024	48430
	MH (medium-hard)	A	F (fine)	9,500	19,100	25	42759102	48435
			G (coarse)	9,500	19,100	25	47700204	48513
	H (hard)	A	G (coarse)	9,500	19,100	25	42759141	48439
			F (fine)	9,500	19,100	25	42759142	48438
3	W (soft)	A	G (coarse)	6,400	12,500	25	42759031	48441
		SiC	F (fine)	6,400	12,500	25	42759034	48440
	MH (medium-hard)	A	F (fine)	6,400	12,500	25	42759112	48445
			G (coarse)	6,400	12,500	25	47700205	48514
	H (hard)	A	F (fine)	6,400	12,500	25	42759114	48444
			G (coarse)	6,400	12,500	25	42759151	48449
			F (fine)	6,400	12,500	25	42759152	48448
	CDR system 							
2	W (soft)	A	G (coarse)	9,500	19,100	25	42779021	48451
		SiC	F (fine)	9,500	19,100	25	42779024	48450
	MH (medium-hard)	A	F (fine)	9,500	19,100	25	42779102	48455
			G (coarse)	9,500	19,100	25	47700206	48515
	H (hard)	A	G (coarse)	9,500	19,100	25	42779104	48454
			F (fine)	9,500	19,100	25	42779141	48459
		F (fine)	9,500	19,100	25	42779142	48458	
3	W (soft)	A	G (coarse)	6,400	12,500	25	42779031	48461
		SiC	F (fine)	6,400	12,500	25	42779034	48460
	MH (medium-hard)	A	F (fine)	6,400	12,500	25	42779112	48465
			G (coarse)	6,400	12,500	25	47700207	48516
	H (hard)	A	F (fine)	6,400	12,500	25	42779114	48464
			G (coarse)	6,400	12,500	25	42779151	48469
			F (fine)	6,400	12,500	25	42779152	48468





Felt discs

Designed for polishing with polishing paste bars, grinding pastes, or diamond polishing pastes in face-down grinding on small and medium-sized surfaces.



Special features:

- Convenient to use due to simple handling and low-vibration working.
- No operational disruptions caused by sticking, slipping, or disengaging.
- Highly cost-effective as product can be changed quickly with innovative COMBIDISC® clamping system. Please order abrasive disc holder separately.

	D ₁ [Inch]	Opt. RPM		Item no.	EDP no.
CD system					
	2	2,000 – 4,000	10	42770050	43215
	3	1,200 – 2,500	10	42770075	43216
CDR system					
	2	2,000 – 4,000	10	42003050	43213
	3	1,200 – 2,500	10	42003075	43214

Abrasive disc backing pad

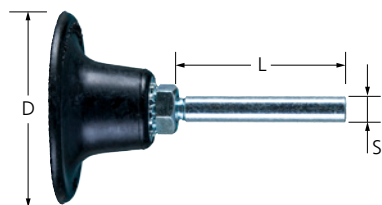

Backing pads

Matching arbors for COMBIDISC® grinding discs. Available in three different hardness grades.

Special features:

- High economic efficiency as disc can be changed quickly. Very comfortable due to ease of use and low-vibration working.
- No operational disruptions caused by sticking, slipping, or disengaging.

	D [Inch]	S [Inch]	L [Inch]	Hardness	Max. RPM		Item no.	EDP no.
CD system								
	1	1/4	1-1/2	M (medium)	40,000	1	47601068	42106
	1-1/2	1/4	1-1/2	W (soft)	20,000	1	47601069	42108
				M (medium)	25,000	1	47601070	42109
	2	1/4	1-1/2	H (hard)	30,000	1	47601071	42110
				W (soft)	20,000	1	47601072	42111
				M (medium)	25,000	1	47601073	42112
	3	1/4	1-1/2	H (hard)	30,000	1	47601074	42113
				W (soft)	12,000	1	47601075	42114
				M (medium)	20,000	1	47601076	42115
				H (hard)	20,000	1	47601077	42116
CDR system								
	1	1/4	1-1/2	M (medium)	40,000	1	47601107	42454
	1-1/2	1/4	1-1/2	W (soft)	20,000	1	47601132	42456
				M (medium)	25,000	1	47601112	42457
				H (hard)	30,000	1	47601105	42458

Continued on next page

D [Inch]	S [Inch]	L [Inch]	Hardness	Max. RPM		Item no.	EDP no.
2	1/4	1-1/2	W (soft)	20,000	1	47601108	42459
			M (medium)	25,000	1	47601113	42460
			H (hard)	30,000	1	47601066	42461
3	1/4	1-1/2	W (soft)	12,000	1	47601109	42462
			M (medium)	20,000	1	47601114	42463
			H (hard)	20,000	1	47601110	42464
4	4	1-1/2	M (medium)	10,000	1	47601199	42465



Adapter for spindle 1/4-20 UNC

The shank of the abrasive disc holders can be replaced by this adapter. SPV-20 CD 1/4-20 UNC, female thread 1/4-20 UNC, male thread 1/4-20 UNC.

Special features:

- With the adapter, the abrasive disc holder can be mounted directly to the drive spindle of the tool.
- Suitable for drives with spindle 1/4-20 UNC, e.g. for PW 3/120 DH.

	Item no.	EDP no.
1	87100727	95808



COMBIDISC® sets



COMBIDISC® prep-to-paint set

Set of various COMBIDISC® tools.

Contents:

Four each of the following abrasive discs: EDP 42506 - 2" CDR A/O 80 grit, EDP 43239 - 2" CDR surface conditioning disc medium. One each of the following: EDP 42913 - CDR mini-POLIFAN® disc A/O 60 grit, EDP 44842 - 2"

CDR POLICLEAN® PLUS disc, EDP 42460 - 2" CDR backing pad medium.

Special features:

- Getting to know and testing the comprehensive system.
- Curated selection of the most common versions.

Diameter [Inch]		Item no.	EDP no.
2	1	47201824	42789



COMBIDISC® mirror finish set

Set of various COMBIDISC® tools.

Contents:

Three each of the following abrasive discs: EDP 43239 - 2" CDR surface conditioning disc medium. Two each of the following: EDP 48454 - 2" CDR unitized disc medium hard SiC Fine. One each of the following: EDP 42913 - CDR mini-POLIFAN® disc A/O 60 grit, EDP 43213 - 2" CDR Felt disc, EDP 48765 - Polishing

paste SS/STL, EDP 42460 - 2" CDR backing pad medium.

Special features:

- Getting to know and testing the comprehensive system.
- Curated selection of the most common versions.

Diameter [Inch]		Item no.	EDP no.
2	1	47201826	42791



COMBIDISC® sanitary finish set

Set of various COMBIDISC® tools.

Contents:

Six each of the following abrasive discs: EDP 42506 - 2" CDR A/O 80 grit, EDP 43239 - 2" CDR surface conditioning disc medium. One each of the following: EDP 42913 - CDR mini-POLIFAN® disc A/O 60 grit, EDP 42460 - 2" CDR backing pad medium.

Special features:

- Getting to know and testing the comprehensive system.
- Curated selection of the most common versions.

Diameter [Inch]		Item no.	EDP no.
2	1	47201825	42790



Quick product selection guide

Material group ▾			Abrasive ▶									
			Rec. peripheral speeds for short and long belts [SPPM]	Aluminum oxide A	Aluminum oxide A compact grain	Zirconia alumina Z	Aluminum oxide A-COOL	Ceramic oxide grain CO	Ceramic oxide grain CO-COOL	VICTOGRAIN®-COOL	Non-woven material	Felt
Steel, cast steel	Non-hardened, non-heat-treated steels	Construction steels, carbon steels, tool steels, non-alloyed steels, cast steel	5,000–7,000	●		○		●		●	●	●
	Hardened, heat-treated steels	Tool steels, tempering steels, alloyed steels, cast steel	4,000–5,000	○	●	●		●		●	○	●
Stainless steel (INOX)	Rust and acid-resistant steels	Austenitic and ferritic stainless steels	3,000–5,000		●	○	●		●	●	●	●
Non-ferrous metals	Soft non-ferrous metals, non-ferrous metals	Soft aluminum alloys	5,000–8,000	○			●		○		●	●
		Brass, copper, zinc		●		○		○		●	●	
	Hard non-ferrous metals	Hard aluminum alloys Bronze, titanium	4,000–5,000	●		○		○		●	●	●
	High-temperature-resistant materials	Nickel-based and cobalt-based alloys	1,000–3,000			○		○		●	●	●
Cast iron	Grey cast iron, white cast iron	Cast iron with flake graphite, with nodular graphite/nodular cast iron, white annealed cast iron, black annealed cast iron	5,000–7,000	●		○		●			●	
Plastics, other materials		Fibre-reinforced plastics, thermoplastics, wood, chipboard, paintwork	2,000–5,000	●							●	●

● = highly recommended ○ = recommended

Safety notes

- Follow the safety notes from FEPA (Federation of European Producers of Abrasives) "Safety notes for correct use of abrasive belts". This information can be found in the download area on www.pferd.com.



Wear eye protection!



Wear hearing protection!



Wear gloves!



Wear a dust mask!



Follow the safety instructions!



Not permitted for wet grinding!

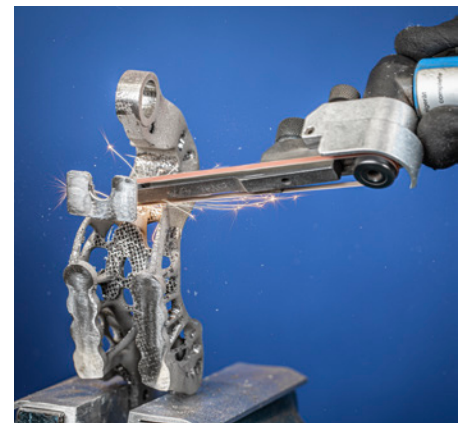

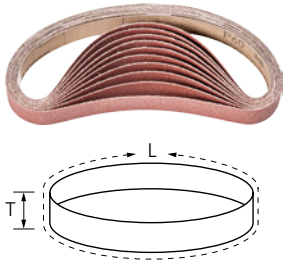

Aluminum oxide A

For universal applications from coarse to fine grinding.



Special features:

- Cost-effective due to high abrasive performance and durability.
- High tear strength with optimum flexibility.
- Consistent work results due to high grain adhesion.

L [Inch]	T [mm]	Abrasive	Grit size		Item no.	EDP no.
12	1/4	A	36	50	47501542	48960
			60	50	47501545	48963
			80	50	47501546	48964
			120	50	47501548	48966
	1/2	A	36	50	47500985	49024
			60	50	45002333	49027
			80	50	45002334	49028
			120	50	45002335	49030
15-1/2	3-1/2	A	40	10	47501171	49312
			60	10	47501173	49314
			80	10	47501174	49315
			100	10	47501175	49316
			120	10	47501176	49317
18	1/4	A	36	50	47500964	49000
			60	50	47500967	49003
			80	50	47500968	49004
			120	50	47500970	49006
	1/2	A	36	50	47500992	49032
			60	50	45002626	49035
			80	50	45002628	49036
			120	50	45002632	49038
	3/4	A	36	50	47501006	49048
			60	50	47501009	49051
			80	50	47501010	49052
			120	50	47501012	49054
21	3	A	40	10	45001104	49211
			60	10	45001106	49213
			80	10	45001108	49214
			100	10	45001110	49215
			120	10	45001112	49216
24	1/4	A	36	50	47500971	49008
			60	50	45002206	49011
			80	50	45002208	49012
			240	50	45002212	49014
	1/2	A	60	50	45002606	49043
			80	50	45002608	49044
			120	50	45002612	49046

Continued on next page

L [Inch]	T [mm]	Abrasive	Grit size		Item no.	EDP no.
24	1/2	A	36	50	47500999	49040
			36	50	47502855	49077
			60	50	47502856	49078
			80	50	47502857	49079
			120	50	47502858	49080
	3	A	40	10	45001134	49250
			60	10	45001136	49252
			80	10	45001138	49253
			100	10	45001140	49254
			120	10	45001142	49255
			4	A	40	10
	60	10			45001306	49362
	80	10			45001308	49363
	100	10			45001310	49364
	120	10			45001312	49365
	36	4	A	60	10	47501220
80				10	47501221	49376
120				10	47501223	49378

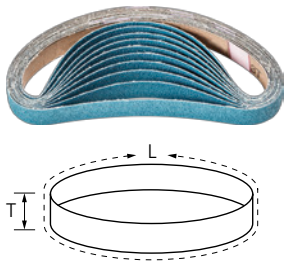

Zirconia alumina Z

For universal coarse grinding with high stock removal and long service life.

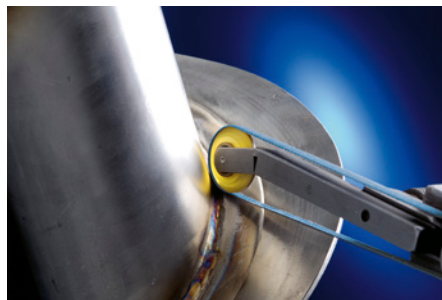

Special features:

- Cost-effective due to high abrasive performance and durability.
- High tear strength with optimum flexibility.
- Consistent work results due to high grain adhesion.

L [Inch]	T [mm]	Abrasive	Grit size		Item no.	EDP no.
12	1/4	Z	36	50	47502860	49682
			60	50	47502861	49683
			80	50	47502862	49684
			120	50	47502863	49685
			36	50	47501679	49712
	1/2	Z	60	50	47501682	49715
			80	50	47501683	49716
			120	50	47502859	49727
			120	50	47502868	49722
			36	50	47501669	49691
18	1/4	Z	60	50	47501672	49694
			80	50	47501673	49695
			36	50	47501298	49717
			60	50	47501301	49720
			80	50	47501302	49730
	1/2	Z	120	50	47502869	49731

Continued on next page

L [Inch]	T [mm]	Abrasive	Grit size		Item no.	EDP no.
18	3/4	Z	36	50	47501684	49740
			60	50	47501687	49743
			80	50	47501688	49744
			120	50	47502870	49745
24	1/4	Z	36	50	47501674	49696
			60	50	47501677	49699
			80	50	47501678	49700
			120	50	47502871	49706
	1/2	Z	36	50	47501303	49734
			60	50	45008206	49738
			80	50	45008208	49739
			120	50	47502872	49752
	3/4	Z	36	50	47502873	49754
			60	50	47502874	49755
			80	50	47502875	49756
			120	50	47502876	49757
36	4	Z	36	10	47501739	49879
			60	10	47501742	49882
			80	10	47501743	49883

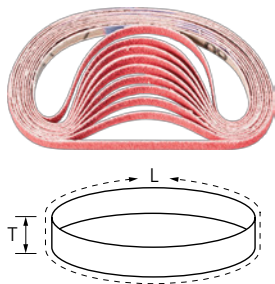

Ceramic oxide grain CO-COOL

Consistently high performance and aggressive grinding due to self-sharpening ceramic oxide grain. Active grinding additives improve the stock removal rate, prevent clogging and result in cooler grinding on hard materials which do not conduct heat well.



Special features:

- Cost-effective due to high abrasive performance and durability.
- High tear strength with optimum flexibility.
- Consistent work results due to high grain adhesion.

L [Inch]	T [mm]	Abrasive	Grit size		Item no.	EDP no.
12	1/4	CO-COOL	40	50	47502877	49492
			60	50	47502878	49493
			80	50	47502879	49494
			120	50	47502880	49495
	1/2	CO-COOL	40	50	47501589	49529
			60	50	47501591	49531
			80	50	47501592	49532
			120	50	47502881	49533
13	3/8	CO-COOL	40	50	47501585	49511
			60	50	47501587	49513
			80	50	47501588	49514
			120	50	79120769	49515
15-1/2	3-1/2	CO-COOL	40	10	47502175	49641

Continued on next page

L [Inch]	T [mm]	Abrasive	Grit size		Item no.	EDP no.	
15-1/2	3-1/2	CO-COOL	60	10	47502176	49642	
			80	10	47502177	49643	
18	1/4	CO-COOL	40	50	47501577	49497	
			60	50	47501579	49499	
			80	50	47501580	49500	
			120	50	47502886	49501	
			40	50	47501593	49536	
	1/2	CO-COOL	60	50	47501595	49538	
			80	50	47501596	49539	
			120	50	47502887	49540	
	3/4	CO-COOL	40	50	47501601	49560	
			60	50	47501603	49562	
			80	50	47501604	49563	
			120	50	47502888	49564	
20-1/2	3/4	CO-COOL	40	50	47501605	49567	
			60	50	47501607	49569	
			80	50	47501608	49570	
24	1/4	CO-COOL	40	50	47501581	49504	
			60	50	47501583	49506	
			80	50	47501584	49507	
			120	50	47502889	49508	
			40	50	47501597	49543	
	1/2	CO-COOL	60	50	47501599	49545	
			80	50	47501600	49546	
			120	50	47502890	49547	
			40	50	47502891	49723	
	3/4	CO-COOL	60	50	47502892	49724	
			80	50	47502893	49725	
			120	50	47502894	49726	
			40	10	47501657	49658	
	36	4	CO-COOL	60	10	47501659	49660
				80	10	47501660	49661
120				10	47502640	49662	



Flexible abrasives

File belts

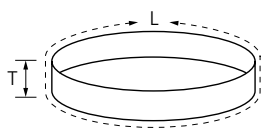
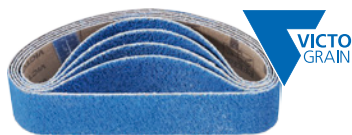

VICTOGRAIN®-COOL

For maximum removal rates with an extremely long service life on steel and materials which are hard or have poor heat-conducting properties. Active grinding additives in the coating substantially improve the stock removal rate, prevent loading and result in cooler grinding.



Special features:

- Cost-effective due to high abrasive performance and durability.
- High tear strength with optimum flexibility.
- Consistent work results due to high grain adhesion.

L [Inch]	T [mm]	Abrasive	Grit size		Item no.	EDP no.
21	3	VICTOGRAIN-COOL	36	10	47502966	49400
24	3	VICTOGRAIN-COOL	36	10	47502967	49401
	4	VICTOGRAIN-COOL	36	10	47502968	49402
36	4	VICTOGRAIN-COOL	36	10	47502969	49403

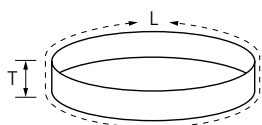

POLIVLIES® surface conditioning belts

Ideal for general work on surfaces such as metal tubular structures, e.g. removing rough grinding traces, removing oxidation and light deburring work. Achieve matt and satin-finished surfaces.



Special features:

- Cost-effective due to high abrasive performance and durability.
- High tear strength with optimum flexibility.
- Consistent work results due to high grain adhesion.

L [Inch]	T [Inch]	Abrasive	Grit size	Version		Item no.	EDP no.
12	1/4	A	100 G	coarse, yellow-brown	10	47202034	43634
			180 M	medium, red-brown	10	47202035	43635
			240 F	fine, blue	10	47202036	43636
	1/2	A	100 G	coarse, yellow-brown	10	47202043	43643
			180 M	medium, red-brown	10	47202044	43644
			240 F	fine, blue	10	47202045	43645
36	4	A	100 G	coarse, yellow-brown	10	47201586	43613
			180 M	medium, red-brown	10	47201587	43614
			240 F	fine, blue	10	47201588	43615
18	1/4	A	100 G	coarse, yellow-brown	10	47201523	43550
			180 M	medium, red-brown	10	47201524	43551
			240 F	fine, blue	10	47201525	43552
	1/2	A	100 G	coarse, yellow-brown	10	47201529	43556
			180 M	medium, red-brown	10	47201530	43557
			240 F	fine, blue	10	47201531	43558

Continued on next page

L [Inch]	T [Inch]	Abrasive	Grit size	Version		Item no.	EDP no.
18	3/4	A	100 G	coarse, yellow-brown	10	47201535	43562
			180 M	medium, red-brown	10	47201536	43563
			240 F	fine, blue	10	47201537	43564
20-1/2	3/4	A	100 G	coarse, yellow-brown	10	47201538	43565
			180 M	medium, red-brown	10	47201539	43566
			240 F	fine, blue	10	47201540	43567
24	1/4	A	100 G	coarse, yellow-brown	10	47201526	43553
			180 M	medium, red-brown	10	47201527	43554
			240 F	fine, blue	10	47201528	43555
	1/2	A	100 G	coarse, yellow-brown	10	47201532	43559
			180 M	medium, red-brown	10	47201533	43560
			240 F	fine, blue	10	47201534	43561
	3/4	A	100 G	coarse, yellow-brown	10	47202578	43666
			180 M	medium, red-brown	10	47202579	43667
			240 F	fine, blue	10	47202580	43668
36	4	A	100 G	coarse, yellow-brown	10	47202572	43660
			180 M	medium, red-brown	10	47202573	43661
			240 F	fine, blue	10	47202574	43662



Belts and accessories for pneumatic drums

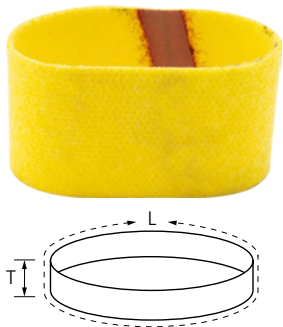

Felt polishing belt

Designed for polishing with polishing paste bars and grinding pastes on tubular constructions and railings.

Special features:

- High economic efficiency due to long service life.
- High tear strength with optimum flexibility.
- Consistent results due to outstanding polishing agent adhesion.

L [Inch]	T [mm]		Item no.	EDP no.
36	4	5	47502167	43659

Flexible abrasives

Pneumatic drum

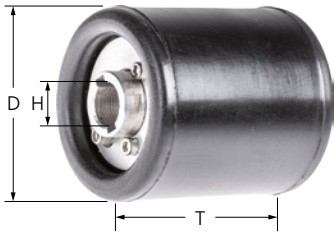

Pneumatic drum

The pneumatic grinding drum is suitable for short belts with a width of 100 mm and a length of 282 mm. The rubber tube yields with increased contact pressure, which is why the abrasive belt adapts very well to the surface to be machined and the contact area increases.

Special features:

- Cost-effective due to high abrasive performance and durability.
- The rubber pneumatic drum holder creates cushioned grinding and increases the service life of belts by reducing heat build-up and allowing more flexibility.

Suitable for short belts [Inch]	D [Inch]	T [Inch]	Max. RPM		Item no.	EDP no.
15-1/2 x 3-1/2	5	3-1/2	3,800	1	47600072	49985

4

Benchstand and Backstand Belts

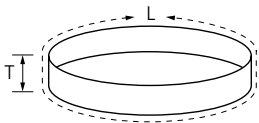

Aluminum oxide A

For universal applications from coarse to fine grinding.

Special features:

- Cost-effective due to high abrasive performance and durability.
- High tear strength with optimum flexibility.
- Consistent results due to outstanding grain adhesion.

L [Inch]	T [mm]	Abrasive	Grit size		Item no.	EDP no.
42	1	A	50	10	47501037	49094
			60	10	47501038	49095
			80	10	47501039	49096
			120	10	47501041	49098
48	2	A	36	10	47501061	49132
			50	10	47501063	49134
			60	10	47501064	49135
			80	10	47501065	49136
			120	10	47501067	49138
	6	A	36	10	47501255	49464
			50	10	47501257	49466
			60	10	47501258	49467
60	2-1/2	A	80	10	47501259	49468
			120	10	47501261	49470
			36	10	47501100	49179
			50	10	47501102	49181
132	2	A	60	10	47501103	49182
			80	10	47501104	49183
			36	10	47501083	49159

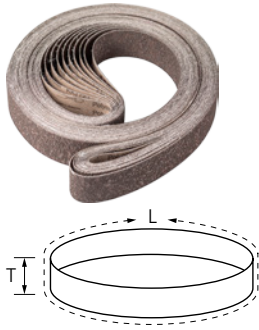

Aluminum oxide A compact grain

Extremely well suited to fine and very fine grinding, and for step-by-step preparations for polishing. The self-sharpening compact grain facilitates a very long service life and achieves consistent surface quality levels throughout the entire service life.



Special features:

- Cost-effective due to high abrasive performance and durability.
- High tear strength with optimum flexibility.
- Consistent work results due to high grain adhesion.

L [Inch]	T [mm]	Abrasive	Grit size		Item no.	EDP no.
72	2	A-CK	320	10	47502997	49823
			400	10	47502998	49824
			600	10	47502999	49825
			800	10	47503000	49826
132	2	A-CK	120	10	47502649	49810
			240	10	47502650	49811
			400	10	47502651	49812
			600	10	47502652	49813

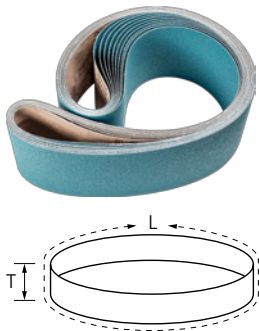

Zirconia alumina Z

For universal coarse grinding with high stock removal and long service life.



Special features:

- Cost-effective due to high abrasive performance and durability.
- High tear strength with optimum flexibility.
- Consistent work results due to high grain adhesion.

L [Inch]	T [mm]	Abrasive	Grit size		Item no.	EDP no.
48	2	Z	36	10	47501699	49786
			60	10	47501702	49789
			80	10	47501703	49790
	6	Z	36	10	47501331	49885
			60	10	47501334	49888
			80	10	47501335	49889
60	2	Z	36	10	47501704	49792
			60	10	47501707	49795
			80	10	47501708	49796
	2-1/2	Z	36	10	47501719	49828
			60	10	47501722	49831
			80	10	47501723	49832

Continued on next page



L [Inch]	T [mm]	Abrasive	Grit size		Item no.	EDP no.
72	2	Z	36	10	47501709	49798
			40	10	47501710	49799
			60	10	47501712	49801
			80	10	47501713	49802
			120	10	47502995	49803

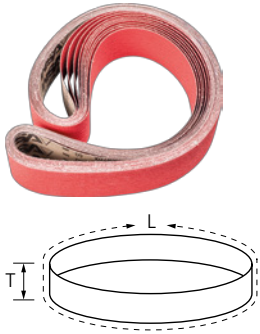

Ceramic oxide grain CO-COOL

Consistently high performance and aggressive grinding due to self-sharpening ceramic oxide grain. Active grinding additives improve the stock removal rate, prevent clogging and result in cooler grinding on hard materials which do not conduct heat well.



Special features:

- Cost-effective due to high abrasive performance and durability.
- High tear strength with optimum flexibility.
- Consistent work results due to high grain adhesion.

L [Inch]	T [mm]	Abrasive	Grit size		Item no.	EDP no.	
48	2	CO-COOL	40	10	47501617	49588	
			60	10	47501619	49590	
			80	10	47501620	49591	
			120	10	47502645	49592	
	6	CO-COOL	40	10	47501665	49672	
			120	10	47502648	49676	
			60	10	47501667	49674	
			80	10	47501668	49675	
60	2	CO-COOL	40	10	47501621	49595	
			60	10	47501623	49597	
			80	10	47501624	49598	
			120	10	47502646	49599	
	2-1/2	CO-COOL	40	10	47501633	49616	
			60	10	47501635	49618	
			80	10	47501636	49619	
			120	10	47502647	49620	
	72	2	CO-COOL	40	10	47501625	49602
				50	10	47501626	49603
				60	10	47501627	49604
				80	10	47501628	49605
120				10	47502996	49606	
132	2	CO-COOL	40	10	47502641	49687	
			80	10	47502643	49689	
			120	10	47502644	49690	

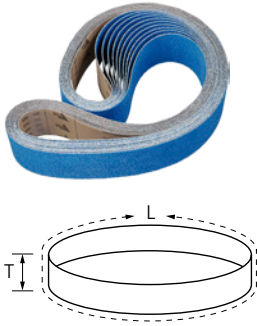

VICTOGRAIN®-COOL

For maximum removal rates with an extremely long service life on steel and materials which are hard or have poor heat-conducting properties. Active grinding additives in the coating substantially improve the stock removal rate, prevent loading and result in cooler grinding.

Special features:

- Cost-effective due to high abrasive performance and durability.
- High tear strength with optimum flexibility.
- Consistent work results due to high grain adhesion.

L [Inch]	T [mm]	Abrasive	Grit size		Item no.	EDP no.
48	2	VICTOGRAIN-COOL	36	10	47502970	49404
	6	VICTOGRAIN-COOL	36	10	47502971	49405
60	2	VICTOGRAIN-COOL	36	10	47502973	49407
	2-1/2	VICTOGRAIN-COOL	36	10	47502972	49406
72	2	VICTOGRAIN-COOL	36	10	47502679	49409
132	2	VICTOGRAIN-COOL	36	10	47502974	49408

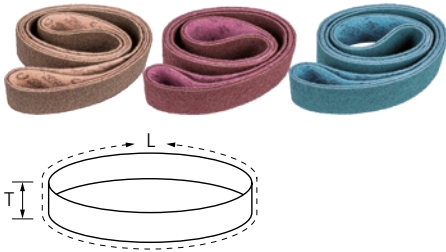

POLIVLIES® surface conditioning belts

Designed for universal work on metal surfaces in stationary applications, e.g. removing rough grinding traces, removing oxidation, and light deburring work. Achieve matte and satin-finished surfaces.

Special features:

- Cost-effective due to high abrasive performance and durability.
- High tear strength with optimum flexibility.
- Consistent work results due to high grain adhesion.

L [Inch]	T [Inch]	Abrasive	Grit size	Version		Item no.	EDP no.
48	2	A	100 G	coarse, yellow-brown	10	47202584	43672
			180 M	medium, red-brown	10	47202585	43673
			240 F	fine, blue	10	47202586	43674
	6	A	100 G	coarse, yellow-brown	10	47202593	43681
			180 M	medium, red-brown	10	47202594	43682
			240 F	fine, blue	10	47202595	43683
60	2	A	100 G	coarse, yellow-brown	10	47202590	43678
			180 M	medium, red-brown	10	47202591	43679
			240 F	fine, blue	10	47202592	43680
	2-1/2	A	100 G	coarse, yellow-brown	10	47202587	43675
			180 M	medium, red-brown	10	47202588	43676
			240 F	fine, blue	10	47202589	43677
72	2	A	100 G	coarse, yellow-brown	10	47201559	43586
			180 M	medium, red-brown	10	47201560	43587
			240 F	fine, blue	10	47201561	43588
132	2	A	100 G	coarse, yellow-brown	10	47202581	43669
			180 M	medium, red-brown	10	47202582	43670
			240 F	fine, blue	10	47202583	43671



Flexible abrasives

Cloth-backed abrasive sheets BG

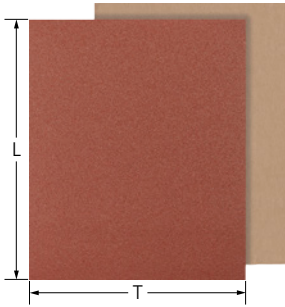

Cloth-backed sheets, heavy-duty

The brown cloth-backed sheet is ideal for universal, heavy-duty use on alloyed and non-alloyed steels, as well as non-ferrous metals.



Special features:

- High grain adhesion on very flexible cloth.
- High abrasive performance.
- Oil and kerosene-resistant.

L [Inch]	T [mm]	Abrasive	Grit size		Item no.	EDP no.
11	9	A	40	50	45013004	46912
			60	50	45013006	46913
			80	50	45013008	46914
			100	50	45013010	46915
			120	50	45013012	46916
			150	50	45013015	46917
			180	50	45013018	46918
			220	50	45013022	46919
			240	50	45013024	46920
			280	50	45013028	46921
			320	50	45013032	46922
			400	50	45013040	46924
			444	50	45013044	46925

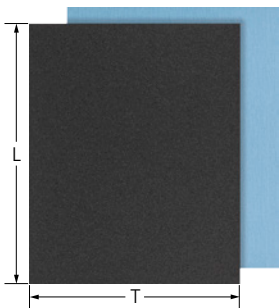

Cloth-backed sheets, standard-duty

The blue cloth-backed sheet is the low-cost alternative for normal workloads on painted wooden and metal surfaces.



Special features:

- High grain adhesion on very flexible cloth.
- Good abrasive performance.

L [Inch]	T [mm]	Abrasive	Grit size		Item no.	EDP no.
11	9	A	60	50	45012006	46901
			80	50	45012008	46902
			100	100	45012010	46903
			120	100	45012012	46904
			180	100	45012018	46906
			220	100	45012022	46907
			240	100	45012024	46908

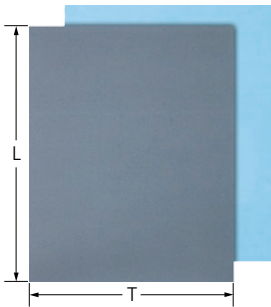

Waterproof (W) SiC version

The SiC abrasive enables use on paint and glass. Ideal for all wet grinding work on conventional painted surfaces.

Special features:

- High grain adhesion on very flexible and light paper.
- Maximum abrasive performance.
- Can be used for wet and dry grinding.

L [Inch]	T [mm]	Abrasive	Grit size		Item no.	EDP no.
11	9	SiC	100	50	45014010	46927
			120	50	45014012	46928
			150	50	45014015	46929
			180	50	45014018	46930
			220	50	45015022	46931
			240	50	45015024	46932
			280	50	45015028	46933
			320	50	45015032	46934
			360	50	45015036	46935
			400	50	45015040	46936
			500	50	45015050	46937
			600	50	45015060	46938
			800	50	45015080	46939
			1000	50	45015100	46940
1200	50	45015120	46941			

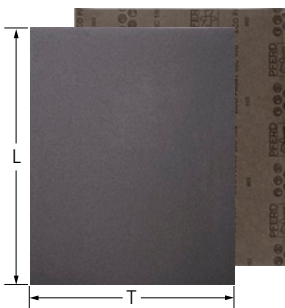

Waterproof (W) ECO SiC version

The ECO W version with silicon carbide (SiC) is a low-cost alternative for use on paint and glass. Particularly suitable for all wet grinding work on conventional painted constructions.

Special features:

- Good grain adhesion on very flexible and light paper.
- Maximum abrasive performance.
- Can be used for wet and dry grinding.

L [Inch]	T [mm]	Abrasive	Grit size		Item no.	EDP no.
11	3/4	SiC	60	50	45015254	46350
			80	50	45015255	46351
			100	50	45015256	46352
			120	50	45015257	46353
			150	50	45015258	46354
			180	50	45015259	46355
			220	50	45015260	46356
			240	50	45015261	46357
			320	50	45015262	46358
			400	50	45015263	46359
			600	50	45015264	46360

Continued on next page

Flexible abrasives

Paper-backed sheets, general-purpose



L [Inch]	T [mm]	Abrasive	Grit size		Item no.	EDP no.
11	3/4	SiC	800	50	45015265	46361
			1000	50	45015266	46362
			1200	50	45015267	46363
			2000	50	45015268	46364

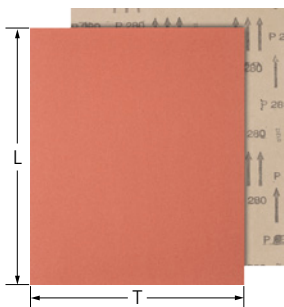

Aluminum oxide A

The aluminum oxide A abrasive is the low-cost alternative for normal workloads when working on painted wooden and metal surfaces.

Special features:

- Good grain adhesion on sturdy paper.
- Good abrasive performance.

L [Inch]	T [mm]	Abrasive	Grit size		Item no.	EDP no.
11	9	A	40	50	45015204	46942
			60	50	45015206	46943
			80	50	45015208	46944
			100	100	45015210	46945
			120	100	45015212	46946
			150	100	45015215	46947
			180	100	45015218	46948
			220	100	45015222	46949
			240	100	45015224	46950
			280	100	45015228	46951
			400	100	45015240	46952

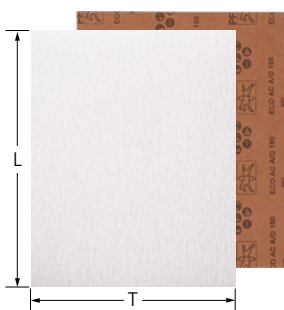

ECO AC version

The stearate coating is a non-stick coating (AC) that prevents the abrasive sheets from clogging. The ECO AC version with aluminum oxide A is a low-cost alternative for general grinding work in industry and professional trades.

Special features:

- High abrasive performance through very good grain adhesion.
- The non-stick coating (AC) prevents loading with low wear.

L [Inch]	T [mm]	Abrasive	Grit size		Item no.	EDP no.
11	9	A	60	50	45015241	46330
			80	50	45015242	46331
			100	50	45015243	46332
			120	50	45015244	46333
			150	50	45015245	46334
			180	50	45015246	46335
			220	50	45015247	46336
240	50	45015248	46337			

Continued on next page

L [Inch]	T [mm]	Abrasive	Grit size		Item no.	EDP no.
11	9	A	320	50	45015249	46338
			400	50	45015250	46339
			600	50	45015251	46340
			800	50	45015252	46341
			1000	50	45015253	46342

Hand pads

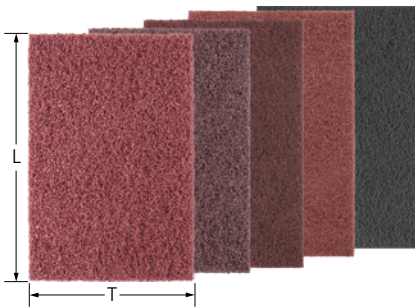

POLINOX® hand pads

Ideal for very fine grinding on small to large surfaces and contours, and for manually cleaning metal and painted surfaces. Achieve matt and satin-finished surfaces. Highly open structure. Available in the aluminum oxide A and silicon carbide SiC types.



Special features:

- Conforms to contours due to high flexibility.
- Access hard-to-reach areas.

L [Inch]	T [mm]	Abrasive	Grit size	Color code		Item no.	EDP no.
9	6	A	100	tan	20	47201625	44606
			180	maroon	20	47201623	44600
			240	green	20	47201628	44613
		SiC	400	grey	20	47201626	44609
			A	-	white	20	47201630



Flexible abrasives

Sanding sponges

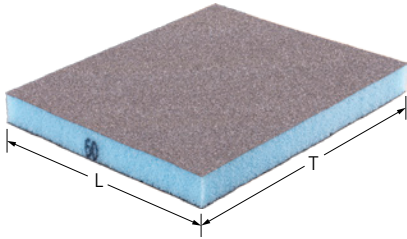

Aluminum oxide A

The sanding sponge is suitable for sanding down flat and irregular surfaces by hand. It is ideal for working on wood, paint and metal, drywall construction and for all types of small workpieces.

Special features:

- Good grain adhesion on the backing material for a long tool life.
- Washable, meaning it can be reused.
- Good abrasive performance.

L [Inch]	T [mm]	Grinding surfaces	Abrasive	Grit size		Item no.	EDP no.
2-3/4	4	4	A	60	5	44697650	46400
				100	5	44697651	46401
				180	5	44697652	46402
4	4-3/4	2	A	60	5	44697653	46404
				100	5	44697654	46405
				180	5	44697655	46406

4



Sanding sponge set

The sanding sponges are suitable for sanding down flat and irregular surfaces by hand. They are ideal for working on wood, paint and metal, drywall construction and for all types of small workpieces. The three-piece set can be used for coarse to fine grinding.

Contents:

One sanding sponge in each of the following grit sizes: 60, 100 and 180.

Special features:

- Good grain adhesion on the backing material for a long tool life.
- Washable, meaning it can be reused.
- Good abrasive performance.

L [Inch]	B [Inch]	H [Inch]		Item no.	EDP no.
2-3/4	4	1	1	44698010	46403
4	4-3/4	1/2	1	44698011	46407

Arbor



Clamping arbor

Shank-mounted arbor for clamping POLINOX® non-woven material, e.g. cut hand pads or non-woven shop rolls.

Special features:

- Designed for universal use.
- Suitable for non-woven material up to 1" wide.
- For working on hard-to-reach inner surfaces such as deep holes.

S [Inch]	L [Inch]		Item no.	EDP no.
1/4	7/8	1	47601216	44837



Heavy-duty shop rolls

Aluminum oxide cloth with a combination resin-over-resin bond most resistant to heat and moisture, very strong bond for best durability. For use on ferrous and non-ferrous metals grinding flat or irregular surfaces, cleaning and polishing of rough ground workpieces.



Special features:

- Conforms to contours due to high flexibility.
- Low wear due to high tear strength and very high grain adhesion.
- Please order matching shop roll holder separately.

T [Inch]	Length [Yards]	D [Inch]	Abrasive	Grit size		Item no.	EDP no.
1	50	3	A	60	1	45016006	47116
				80	1	45016008	47117
				100	1	45016010	47118
				120	1	45016012	47119
				150	1	45016015	47120
				180	1	45016018	47121
				240	1	45016024	47123
				320	1	45016032	47125
				400	1	45016040	47126
1-1/2	50	3	A	60	1	45016106	47166
				80	1	45016108	47167
				100	1	45016110	47168
				120	1	45016112	47169
				150	1	45016115	47170
				180	1	45016118	47171
				220	1	45016122	47172
				240	1	45016124	47173
				320	1	45016132	47175
2	50	3	A	60	1	45016206	47216
				80	1	45016208	47217
				100	1	45016210	47218
				120	1	45016212	47219
				150	1	45016215	47220
				180	1	45016218	47221
				220	1	45016220	47222
				240	1	45016224	47223
				320	1	45016232	47225
400	1	45016240	47226				

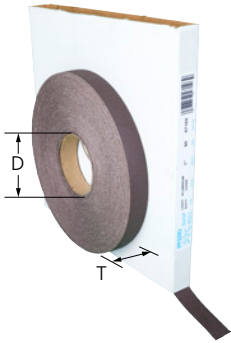

Light cloth, flexible shop rolls

The shop rolls offer good heat resistance and ensure smooth surface finishes. The cloth-backed variant is suitable for general, heavy-duty use on alloyed and non-alloyed steels, as well as non-ferrous metals.

Special features:

- Conforms to contours due to high flexibility.
- Little wear due to high tear strength and very good grain adhesion. Please order matching shop roll holder separately.

T [Inch]	Length [Yards]	D [Inch]	Abrasive	Grit size		Item no.	EDP no.
1	50	3	A	50	1	47301056	47101
				60	1	47301057	47102
				80	1	47301058	47103
				100	1	47301059	47104
				120	1	47301060	47105
				150	1	47301061	47106
				180	1	47301062	47107
				220	1	47301063	47108
				240	1	47301064	47109
				320	1	47301066	47111
				400	1	47301067	47112
				500	1	47301068	47113
				1-1/2	50	3	A
60	1	47301084	47152				
80	1	47301085	47153				
100	1	47301086	47154				
120	1	47301087	47155				
150	1	47301088	47156				
180	1	47301089	47157				
220	1	47301090	47158				
240	1	47301091	47159				
320	1	47301093	47161				
400	1	47301094	47162				
500	1	47301095	47163				
2	50	3	A				
				60	1	47301111	47202
				80	1	47301112	47203
				100	1	47301113	47204
				120	1	47301114	47205
				150	1	47301115	47206
				180	1	47301116	47207
				220	1	47301117	47208
				240	1	47301118	47209
				320	1	47301120	47211
				400	1	47301121	47212
				500	1	47301122	47213

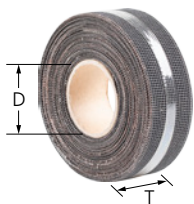

Screen rolls

For universal grinding work on components made from aluminum, copper, bronze, titanium and fibre-reinforced plastics. Recommended for use on titanium alloys. Ideally suited to use in the aeronautical industry, especially where SiC is the only approved abrasive, e.g. for use on engine components.

Special features:

- Conforms to contours due to high flexibility.
 - Low wear due to high tear strength and very high grain adhesion.
- Please order matching shop roll holder separately.

T [Inch]	Length [Yards]	Abrasive	Grit size		Item no.	EDP no.
1-1/2	10	SiC	80	1	47301139	47233
			120	1	47301140	47234
			180	1	47301141	47235

Shop rolls and holders



Shop roll holders

Holder for wall-mounting: for storing and tearing off to the required length as necessary. With the multi-roll holder, various roll sizes can be combined with each other as desired.

Special features:

- Allows shop rolls to be properly stored.

Number of rolls	Suitable for roll width [Inch]	Suitable for roll diameter [Inch]		Item no.	EDP no.
1	1, 1-1/2, 2	15	1	42990001	47238



Multi-roll shop holder

Holder for wall mounting: For storing and tearing off to the required length as necessary. Various roll sizes can be combined with each other as desired.

Special features:

- Allows shop rolls to be properly stored.

Number of rolls	Suitable for roll width [Inch]	Suitable for roll diameter [Inch]		Item no.	EDP no.
5	1, 1-1/2, 2	10	1	42990007	47239

Flexible abrasives

Non-woven shop rolls



Aluminum oxide A and silicon carbide SiC

Designed for very fine grinding on small to large surfaces and contours, and for manually cleaning metal and painted surfaces. Achieve matte and satin-finished surfaces. Highly open structure.



Special features:

- Conforms to contours due to high flexibility.
- Access hard-to-reach areas.

T [Inch]	Length [Yards]	Abrasive	Grit size		Item no.	EDP no.
4	10	A	80	1	45018308	43515
			100	1	45018310	43516
			180	1	45018318	43517
			280	1	45018328	43518
		SiC	400	1	45018440	43519

Abrasive cord



High flexibility abrasive cord

Ideal for very fine deburring and finishing work in hard-to-reach places. Recommended for work on very small holes, grooves and cut-outs in tool and die making.

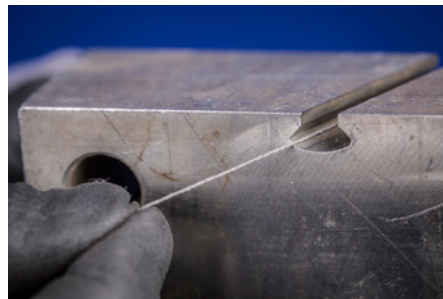

Special features:

- Conforms to contours due to high flexibility.
- Low wear due to high tear strength and very high grain adhesion.
- The abrasive cord can be shortened to the required length.

D [Inch]	Length [Yards]	Grit size		Item no.	EDP no.
Silicon carbide SiC					
0.02	16	200	1	45019001	49900
Aluminum oxide A					
0.03	16	200	1	45019002	49901
0.04	16	180	1	45019003	49902
0.06	16	150	1	45019004	49903
0.07	16	180	1	45019005	49904
0.08	16	120	1	45019006	49905

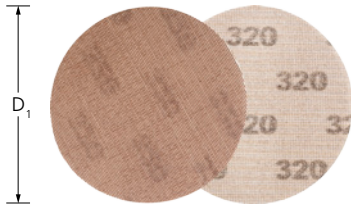

Aluminum oxide A

Hook and loop-backed abrasive discs in the NET type feature a netting fabric, to which the abrasive grain is bonded with a high-performance bond system, which makes it very durable. For dust-free, general grinding work on medium-sized and large surfaces.



Special features:

- Very long service life and high stock removal rate.
- Very fine, even surfaces can be achieved.
- Durable netting structure with high tear strength and edge stability.

D ₁ [Inch]	Abrasive	Grit size		Item no.	EDP no.
5	A	80	25	45018001	47520
		100	25	45018002	47521
		120	25	45018003	47522
		150	25	45018004	47523
		180	25	45018005	47524
		240	25	45018006	47525
		320	25	45018007	47526
		400	25	45018008	47527
		600	25	45018009	47528
		800	25	45018010	47529
		1000	25	45018011	47530
6	A	80	25	45018012	47531
		100	25	45018013	47532
		120	25	45018014	47533
		150	25	45018015	47534
		180	25	45018016	47535
		240	25	45018017	47536
		320	25	45018018	47537
		400	25	45018019	47538
		600	25	45018020	47539
		800	25	45018021	47540
		1000	25	45018022	47541



Abrasive spiral bands

General information



Quick product selection guide

			Abrasive ▶				
			Aluminum oxide A	Zirconia alumina Z	Zirconia alumina Z-COOL	Ceramic oxide grain CO-COOL	Silicon carbide SiC
Material group ▼							
Steel, cast steel	Non-hardened, non-heat-treated steels	Construction steels, carbon steels, tool steels, non-alloyed steels, cast steel	●	○		●	
	Hardened, heat-treated steels	Tool steels, tempering steels, alloyed steels, cast steel	○	●		●	
Stainless steel (INOX)	Rust and acid-resistant steels	Austenitic and ferritic stainless steels		○	●	●	
Non-ferrous metals	Soft non-ferrous metals, non-ferrous metals	Soft aluminum alloys	○		○	○	
		Brass, copper, zinc	●	○	○		
	Hard non-ferrous metals	Hard aluminum alloys	●	○	○		○
		Bronze, titanium		○	●	●	●
	High-temperature-resistant materials	Nickel-based and cobalt-based alloys		○	●	●	
Cast iron	Grey cast iron, white cast iron	Cast iron with flake graphite, with nodular graphite/nodular cast iron, white annealed cast iron, black annealed cast iron	●	○			
Plastics, other materials		Fibre-reinforced plastics, thermoplastics, wood, chipboard, paintwork	●				●

● = highly recommended ○ = recommended

Safety notes

- The maximum permitted peripheral speed is 6,000 SFPM.
- For safety reasons, the maximum permitted rotational speed indicated must never be exceeded.
- Do not allow abrasive spiral bands to protrude beyond the rubber drum holder.



Wear eye protection!



Wear hearing protection!



Wear gloves!



Wear a dust mask!



Follow the safety instructions!



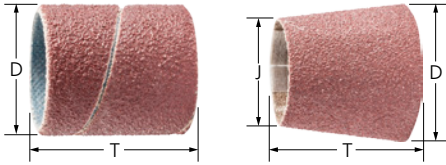

Aluminum oxide A

For general applications from coarse to fine grinding. The package size is ideal for industrial requirements.



Special features:

- The abrasive spiral band is firmly held in place on the rubber drum holder as the holder expands during use. The rubber drum holder must be ordered separately.
- Outstanding service life due to a special manufacturing process – even under the toughest work conditions.
- Highest possible cost-effectiveness due to particularly high stock removal rate and aggressiveness of the abrasive.

D [Inch]	J [Inch]	T [Inch]	Abrasive	Grit size	Opt. RPM		Item no.	EDP no.
Cylindrical shape								
3/8	-	3/4	A	80	30,000 – 44,000	100	42202108	41022
				150	30,000 – 44,000	100	42202115	41023
				240	30,000 – 44,000	100	42202124	41024
1/2	-	1	A	80	30,000 – 44,000	100	42204108	41046
				150	30,000 – 44,000	100	42204115	41049
5/8	-	1-1/8	A	50	26,000 – 36,000	100	42206103	41068
				60	26,000 – 36,000	100	42206105	41069
				80	26,000 – 36,000	100	42206108	41070
				150	26,000 – 36,000	100	42206115	41072
				240	26,000 – 36,000	100	42206124	41074
3/4	-	1	A	60	20,000 – 30,000	100	42206505	41102
				80	20,000 – 30,000	100	42206508	41103
				150	20,000 – 30,000	100	42206515	41106
7/8	-	3/4	A	50	18,000 – 26,000	100	42207104	41131
				60	18,000 – 26,000	100	42207105	41132
				80	18,000 – 26,000	100	42207108	41133
				150	18,000 – 26,000	100	42207115	41135
				240	18,000 – 26,000	100	42207124	41137
1	-	1	A	60	16,000 – 22,900	100	42207505	41149
				80	16,000 – 22,900	100	42207508	41150
				150	16,000 – 22,900	100	42207515	41153
1-1/8	-	1-1/8	A	40	13,000 – 19,100	100	42209104	41190
				50	13,000 – 19,100	100	42209103	41191
				60	13,000 – 19,100	100	42209105	41192
				80	13,000 – 19,100	100	42209108	41193
				150	13,000 – 19,100	100	42209115	41195
				240	13,000 – 19,100	100	42209124	41197
1-1/2	-	1	A	40	10,000 – 15,900	100	42209504	41200
				60	10,000 – 15,900	100	42209505	41202
				80	10,000 – 15,900	100	42209508	41203
				150	10,000 – 15,900	100	42209515	41206
1-3/4	-	1-1/8	A	40	8,500 – 12,700	100	42210104	41238
				50	8,500 – 12,700	100	42210103	41239
				60	8,500 – 12,700	100	42210105	41240
				80	8,500 – 12,700	100	42210108	41241

Continued on next page



Abrasive spiral bands

Abrasive spiral bands



D [Inch]	J [Inch]	T [Inch]	Abrasive	Grit size	Opt. RPM		Item no.	EDP no.
1-3/4	-	1-1/8	A	150	8,500 – 12,700	100	42210115	41243
				240	8,500 – 12,700	100	42210124	41245
2	-	1	A	40	7,500 – 11,200	100	42210504	41248
				60	7,500 – 11,200	100	42210505	41250
				80	7,500 – 11,200	100	42210508	41251
				150	7,500 – 11,200	100	42210515	41254
				40	6,500 – 9,500	100	42211104	41295
2-3/8	-	1-1/8	A	50	6,500 – 9,500	100	42211103	41296
				60	6,500 – 9,500	100	42211105	41297
				80	6,500 – 9,500	100	42211108	41298
				150	6,500 – 9,500	100	42211115	41300
				40	19,000 – 26,000	100	42214104	41350
3/4	1/2	2-1/2	A	60	19,000 – 26,000	100	42214105	41351
				80	19,000 – 26,000	100	42214108	41352
				150	19,000 – 26,000	100	42214115	41353
				40	13,000 – 19,100	100	42215104	41355
1-1/8	7/8	1-3/16	A	60	13,000 – 19,100	100	42215105	41356
				80	13,000 – 19,100	100	42215108	41357
				150	13,000 – 19,100	100	42215115	41358
				40	10,000 – 15,900	100	42216104	41360
1-1/2	7/8	2-3/8	A	60	10,000 – 15,900	100	42216105	41361
				80	10,000 – 15,900	100	42216108	41362
				150	10,000 – 15,900	100	42216115	41363

Tapered shape

3/4	1/2	2-1/2	A	40	19,000 – 26,000	100	42214104	41350
				60	19,000 – 26,000	100	42214105	41351
				80	19,000 – 26,000	100	42214108	41352
				150	19,000 – 26,000	100	42214115	41353
1-1/8	7/8	1-3/16	A	40	13,000 – 19,100	100	42215104	41355
				60	13,000 – 19,100	100	42215105	41356
				80	13,000 – 19,100	100	42215108	41357
				150	13,000 – 19,100	100	42215115	41358
1-1/2	7/8	2-3/8	A	40	10,000 – 15,900	100	42216104	41360
				60	10,000 – 15,900	100	42216105	41361
				80	10,000 – 15,900	100	42216108	41362
				150	10,000 – 15,900	100	42216115	41363

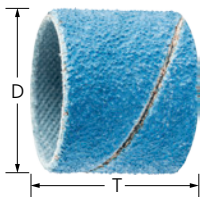

Zirconia alumina Z-COOL

For coarse grinding work with a high stock removal rate and cool grinding. Active grinding additives in the coating substantially improve the stock removal rate, prevent clogging and result in cooler grinding. The package size is ideal for industrial requirements.



Special features:

- Abrasive spiral bands fit securely on the rubber drum holder as the holder expands during use. The rubber drum holder must be ordered separately.
- Outstanding service life due to a special manufacturing process – even under the toughest work conditions.
- Highest possible cost-effectiveness due to particularly high stock removal rate and aggressiveness of the abrasive.

D [Inch]	T [Inch]	Abrasive	Grit size	Opt. RPM		Item no.	EDP no.
Cylindrical shape							
5/8	1-1/8	Z-COOL	50	26,000 – 36,000	100	42206183	41405
			80	26,000 – 36,000	100	42206188	41406
			150	26,000 – 36,000	100	42206285	41407
7/8	3/4	Z-COOL	50	18,000 – 26,000	100	42207184	41408
			80	18,000 – 26,000	100	42207188	41409
			150	18,000 – 26,000	100	42207285	41410
1-1/8	1-1/8	Z-COOL	36	13,000 – 19,100	100	42209182	41415

Continued on next page

D [Inch]	T [Inch]	Abrasive	Grit size	Opt. RPM		Item no.	EDP no.
1-1/8	1-1/8	Z-COOL	50	13,000 – 19,100	100	42209183	41416
			80	13,000 – 19,100	100	42209188	41417
			150	13,000 – 19,100	100	42209285	41418
1-3/4	1-1/8	Z-COOL	36	8,500 – 12,700	100	42210182	41419
			50	8,500 – 12,700	100	42210183	41420
			80	8,500 – 12,700	100	42210188	41421
			150	8,500 – 12,700	100	42210285	41422
2-3/8	1-1/8	Z-COOL	36	6,500 – 9,500	100	42211182	41427
			50	6,500 – 9,500	100	42211183	41428
			80	6,500 – 9,500	100	42211188	41429
			150	6,500 – 9,500	100	42211285	41430

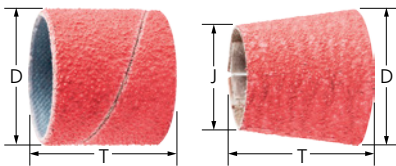

Ceramic oxide grain CO-COOL

Consistently high performance and aggressive grinding due to self-sharpening ceramic oxide grain. Active grinding additives improve the stock removal rate, prevent clogging and result in cooler grinding. The package size is ideal for industrial requirements.



Special features:

- Abrasive spiral bands fit securely on the rubber drum holder as the holder expands during use. The rubber drum holder must be ordered separately.
- Outstanding service life due to a special manufacturing process – even under the toughest work conditions.
- Highest possible cost-effectiveness due to particularly high stock removal rate and aggressiveness of the abrasive.

D [Inch]	J [Inch]	T [Inch]	Abrasive	Grit size	Opt. RPM		Item no.	EDP no.
Tapered shape								
3/4	1/2	2-1/2	CO-COOL	36	19,000 – 26,000	100	42217182	41388
				60	19,000 – 26,000	100	42217183	41389
				80	19,000 – 26,000	100	42217184	41390
				120	19,000 – 26,000	100	42217185	41391
1-1/8	7/8	1-3/16	CO-COOL	36	13,000 – 19,100	100	42217186	41392
				60	13,000 – 19,100	100	42217187	41393
				80	13,000 – 19,100	100	42217188	41394
				120	13,000 – 19,100	100	42217189	41395
1-1/2	7/8	2-3/8	CO-COOL	36	10,000 – 15,900	100	42217190	41396
				60	10,000 – 15,900	100	42217191	41397
				80	10,000 – 15,900	100	42217192	41398
				120	10,000 – 15,900	100	42217193	41399



Abrasive spiral bands

Rubber drum holder

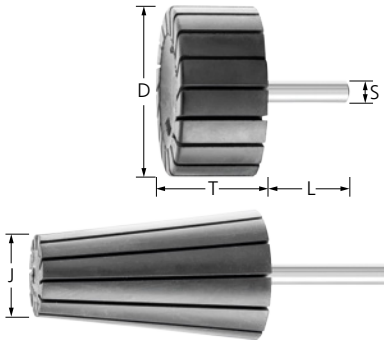

Conical and cylindrical

Matching holder for conical and cylindrical abrasive spiral bands. Rubber drum holders marked "H" are the harder type and permit grinding at higher contact pressure. They are exceptionally well-suited to work on weld seams.

Special features:

- Abrasive spiral bands fit securely on the rubber drum holder as the holder expands during use.
- Outstanding service life due to a special manufacturing process – even under the toughest work conditions.

D [Inch]	J [Inch]	T [Inch]	S [Inch]	L [Inch]	Max. RPM	Min. RPM		Item no.	EDP no.
Cylindrical shape									
3/8	-	3/4	1/4	1-5/8	44,000	30,000	5	47601137	41966
1/2	-	1	1/4	1-5/8	44,000	30,000	5	47601138	41970
3/5	-	1-1/6	1/4	1-5/8	36,000	26,000	5	47601139	41973
3/4	-	1	1/4	1-5/8	30,000	20,000	5	47601140	41976
7/8	-	3/4	1/4	1-5/8	26,000	18,000	5	47601141	41979
1	-	1	1/4	1-5/8	22,900	16,000	5	47601142	41982
1-1/8	-	1-1/6	1/4	1-1/4	19,100	13,000	5	47601143	41985
1-1/2	-	1	1/4	1-1/4	15,900	10,000	5	47601144	41988
1-4/5	-	1-1/6	1/4	1-1/4	12,700	8,500	5	47601145	41991
2	-	1	1/4	1-1/4	11,200	7,500	5	47601146	41994
2-3/8	-	1-1/6	1/4	1-1/4	9,500	6,500	5	47601147	41997
Tapered shape									
3/4	1/2	1-3/16	1/4	1-5/8	26,000	19,000	5	47601148	42005
1-1/8	7/8	1-1/6	1/4	1-5/8	19,100	13,000	5	47601149	42007
1-1/2	7/8	2-3/8	1/4	1-5/8	15,900	10,000	5	47601150	42006



Safety notes

- The maximum permitted peripheral speed is 2,300 SFPM.
- For safety reasons, the maximum permitted rotational speed indicated must never be exceeded.



Wear eye protection!



Wear hearing protection!



Wear gloves!



Wear a dust mask!



Follow the safety instructions!



Not permitted for wet grinding!

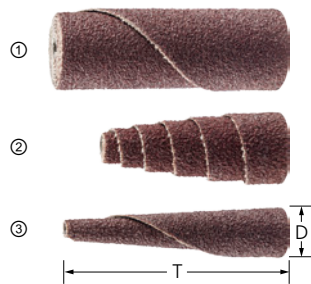
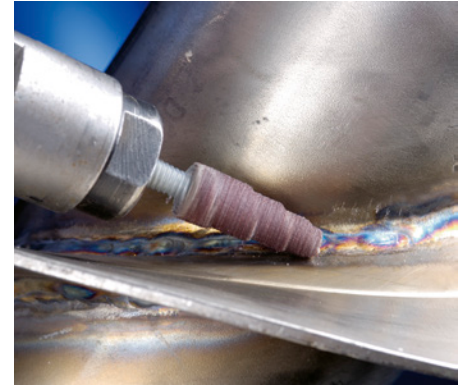

Aluminum oxide A

They consist of spirally wound coated abrasives. The abrasive grain is embedded in the resinoid coating on the sturdy backing material, which achieves the best possible abrasive performance.

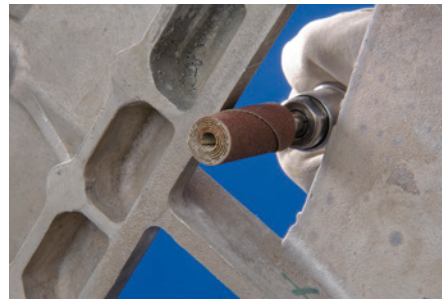

Special features:

- Consistently high grinding performance due to self-sharpening abrasive grain.
- Secure fit of the POLIROLL® when in use due to self-tensioning provided by grooved, conical arbor. Easy cartridge changing.
- Please order compatible arbor separately.

POLIROLL® cartridge rolls



D [Inch]	T [Inch]	Abrasive	Grit size	Opt. RPM	Max. RPM	Suitable arbors		Item no.	EDP no.
(1) Cylindrical shape									
1/4	1	A	60	20,000	25,000	47601170	50	47101122	41468
			80	20,000	25,000	47601170	50	47101123	41469
			120	20,000	25,000	47601170	50	47101125	41471
	1-1/2	A	60	20,000	25,000	47601161	50	47101129	41479
			80	20,000	25,000	47601161	50	47101130	41480
			120	20,000	25,000	47601161	50	47101132	41482
5/16	1-1/2	A	60	18,500	23,000	47601161	50	47101136	41512
			80	18,500	23,000	47601161	50	47101137	41513
			120	18,500	23,000	47601161	50	47101139	41515
3/8	1	A	60	16,000	24,000	47601170	50	47101140	41523
			80	16,000	24,000	47601170	50	47101141	41524
			120	16,000	24,000	47601170	50	47101143	41526
	1-1/2	A	60	16,000	24,000	47601161	50	47101144	41534
			80	16,000	24,000	47601161	50	47101145	41535
			120	16,000	24,000	47601161	50	47101147	41537
	2	A	60	16,000	24,000	47601162	50	47101151	41545
			80	16,000	24,000	47601162	50	47101152	41546

Continued on next page



D [Inch]	T [Inch]	Abrasive	Grit size	Opt. RPM	Max. RPM	Suitable arbors		Item no.	EDP no.	
3/8	2	A	120	16,000	24,000	47601162	50	47101154	41548	
1/2	1	A	60	12,000	18,000	47601170	50	47101155	41567	
			80	12,000	18,000	47601170	50	47101156	41568	
			120	12,000	18,000	47601170	50	47101158	41570	
			60	12,000	18,000	47601161	50	47101160	41589	
	1-1/2	A	80	12,000	18,000	47601161	50	47101161	41590	
			120	12,000	18,000	47601161	50	47101163	41592	
			60	12,000	18,000	47601162	50	47101167	41600	
	2	A	80	12,000	18,000	47601162	50	47101168	41601	
			120	12,000	18,000	47601162	50	47101170	41603	
60			9,500	15,000	47601161	50	47101171	41633		
5/8	1-1/2	A	80	9,500	15,000	47601161	50	47101172	41634	
			120	9,500	15,000	47601161	50	47101174	41636	
			60	8,000	12,000	47601170	50	47101175	41666	
3/4	1	A	80	8,000	12,000	47601170	50	47101176	41667	
			120	8,000	12,000	47601170	50	47101178	41669	
			60	8,000	12,000	47601163	50	47101180	41677	
	1-1/2	A	80	8,000	12,000	47601163	50	47101181	41678	
			120	8,000	12,000	47601163	50	47101183	41680	
			60	8,000	12,000	47601164	50	47101184	41721	
	2	A	80	8,000	12,000	47601164	50	47101185	41722	
			120	8,000	12,000	47601164	50	47101187	41724	
			60	6,000	9,000	47601165	25	47101189	41743	
	1	1-1/2	A	80	6,000	9,000	47601165	25	47101190	41744
				120	6,000	9,000	47601165	25	47101192	41746
				60	6,000	9,000	47601166	25	47101193	41776
2		A	80	6,000	9,000	47601166	25	47101194	41777	
			120	6,000	9,000	47601166	25	47101196	41779	
			60	16,000	24,000	47601170	50	47101197	41800	
(2) Conical shape	3/8	1	A	80	16,000	24,000	47601170	50	47101198	41801
				120	16,000	24,000	47601170	50	47101199	41803
				60	16,000	24,000	47601161	50	47101201	41807
		1-1/2	A	80	16,000	24,000	47601161	50	47101202	41808
				120	16,000	24,000	47601161	50	47101203	41810
				60	12,000	18,000	47601170	50	47101205	41817
	1/2	1	A	80	12,000	18,000	47601170	50	47101206	41818
				120	12,000	18,000	47601170	50	47101207	41820
				60	12,000	18,000	47601161	50	47101209	41827
		1-1/2	A	80	12,000	18,000	47601161	50	47101210	41828
				120	12,000	18,000	47601161	50	47101211	41830
				60	12,000	18,000	47601162	50	47101213	41837
		2	A	80	12,000	18,000	47601162	50	47101214	41838
				120	12,000	18,000	47601162	50	47101215	41840
				60	8,000	12,000	47601163	50	47101216	41874
3/4	1-1/2	A	80	8,000	12,000	47601163	50	47101217	41875	
			120	8,000	12,000	47601163	50	47101218	41876	
			60	8,000	12,000	47601164	50	47101219	41882	
	2	A	80	8,000	12,000	47601164	50	47101220	41883	
			120	8,000	12,000	47601164	50	47101221	41884	
			60	8,000	12,000	47601164	50	47101222	41884	



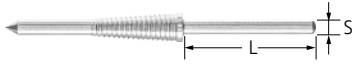

Arbor

Tapered and untapered cartridge roll holders for POLIROLL® cartridge rolls.

Special features:

- Roll can be changed without unclamping the arbor from the power tool collet.

- Arbors for POLIROLL® cartridge rolls.

Suitable for arbor hole	S [Inch]	L [Inch]		Item no.	EDP no.
1/8	1/4	1	1	47601170	42060
				47601161	42061
				47601162	42062
3/16	1/4	1	1	47601163	42063
				47601164	42064
1/4	1/4	1	1	47601165	42066
				47601166	42067



Quick product selection guide

			Abrasive ▶		
Material group ▼			Aluminum oxide A	Ceramic oxide grain CO-COOL	Silicon carbide SiC-COOL
Steel, cast steel	Non-hardened, non-heat-treated steels	Construction steels, carbon steels, tool steels, non-alloyed steels, cast steel	●	○	
	Hardened, heat-treated steels	Tool steels, tempering steels, alloyed steels, cast steel	○	●	
Stainless steel (INOX)	Rust and acid-resistant steels	Austenitic and ferritic stainless steels		●	
Non-ferrous metals	Soft non-ferrous metals, non-ferrous metals	Soft aluminum alloys	○	○	●
		Brass, copper, zinc	●		
	Hard non-ferrous metals	Hard aluminum alloys	○		●
		Bronze, titanium		○	●
	High-temperature-resistant materials	Nickel-based and cobalt-based alloys		●	
Cast iron	Grey cast iron, white cast iron	Cast iron with flake graphite, with nodular graphite/nodular cast iron, white annealed cast iron, black annealed cast iron	●	○	
Plastics, other materials		Fibre-reinforced plastics, thermoplastics, wood, chipboard, paintwork	○		●

● = highly recommended ○ = recommended

Color code

POLICAP® abrasive caps are available in different types and with different grains.

- Silicon carbide SiC-COOL (grey)
- Ceramic oxide grain (CO-COOL) red
- Color code for the grit sizes for aluminum oxide A: 60/80 - brown, 150 - black, 280 - red-brown



Safety notes

- The maximum permitted peripheral speed is 5,500 SFPM.
- For safety reasons, the maximum permitted rotational speed indicated must never be exceeded.

 Wear eye protection!

 Wear hearing protection!

 Wear gloves!

 Wear a dust mask!

 Follow the safety instructions!





Cylindrical, shape A

POLICAP® abrasive caps in cylindrical shape A with aluminum oxide A as the abrasive. They have a seamless design, and the entire surface can be used.



Special features:

- The abrasive caps are firmly held in place on the holder as the holder expands during use, plus easy product changing.
- Consistent shape accuracy and excellent fine grinding due to special manufacturing.
- Optimally matched, reusable holders are available. The holder must be ordered separately.

D [Inch]	T [Inch]	Abrasive	Grit size	Opt. RPM		Item no.	EDP no.
3/16	3/8	A	80	40,000	50	42301051	46029
			150	40,000	50	42301052	46030
			280	40,000	50	42301053	46031
9/32	1/2	A	60	30,000	50	42301071	46032
			150	30,000	50	42301072	46033
			280	30,000	50	42301073	46034
3/8	5/8	A	60	20,000	50	42301101	46035
			150	20,000	50	42301102	46036
			280	20,000	50	42301103	46037
1/2	11/16	A	60	16,000	50	42301131	46065
			150	16,000	50	42301132	46066
			280	16,000	50	42301133	46067
5/8	1	A	60	12,000	50	42301161	46068
			150	12,000	50	42301162	46069
			280	12,000	50	42301163	46070

Matching POLICAP® abrasive cap holder in cylindrical shape A

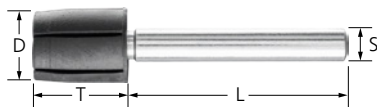

Matching POLICAP® abrasive cap holder in cylindrical shape A

Cylindrical, shape A holders

Special features:

- Abrasive caps and cones fit securely on the holder as it expands during use.

- Easy product change.

D [Inch]	T [Inch]	S [Inch]	L [Inch]	Max. RPM		Item no.	EDP no.
3/16	3/8	1/8	1-1/4	95,000	5	42153000	42008
9/32	1/2	1/8	1-1/4	65,000	5	42153005	42009
3/8	3/5	1/8	1-1/4	45,000	5	42153010	42010
1/2	11/16	1/4	1-5/8	35,000	5	42154015	42021
5/8	1	1/4	1-5/8	30,000	5	42154020	42022



Cylindrical, shape A set

110-piece set of various POLICAP® abrasive caps with matching holders in cylindrical shape A.



Contents:

Contents: 105 pieces POLICAP® abrasive caps, 5 pieces POLICAP® abrasive cap holders.

Special features:

- Abrasive caps and cones fit securely on the holder as it expands during use.
- Consistent shape accuracy and excellent fine grinding due to special manufacturing.
- Easy product change.

Shape	L [Inch]	B [Inch]	H [Inch]		Item no.	EDP no.
A	7	5-3/4	1-1/2	1	49601101	46093

POLICAP® Cylindrical with radius end, shape C

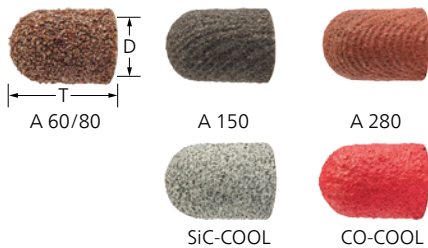

Cylindrical with radius end, shape C

POLICAP® abrasive caps in cylindrical shape with radius end. Available in aluminum oxide A, silicon carbide SiC-COOL and ceramic oxide grain CO-COOL. They have a seamless design, and the entire surface can be used.



Special features:

- The abrasive caps are firmly held in place on the holder as the holder expands during use, plus easy product changing.
- Consistent shape accuracy and excellent fine grinding due to special manufacturing.
- Optimally matched, reusable holders are available. The holder must be ordered separately.

D [Inch]	T [Inch]	Abrasive	Grit size	Opt. RPM		Item no.	EDP no.
Aluminum oxide A							
3/16	7/16	A	80	40,000	50	42302051	46038
			150	40,000	50	42302052	46039
			280	40,000	50	42302053	46040
9/32	1/2	A	60	30,000	50	42302071	46041
			150	30,000	50	42302072	46042
			280	30,000	50	42302073	46043
3/8	5/8	A	60	20,000	50	42302101	46044
			150	20,000	50	42302102	46045
			280	20,000	50	42302103	46046
1/2	11/16	A	60	16,000	50	42302131	46071
			150	16,000	50	42302132	46072
			280	16,000	50	42302133	46073
5/8	1	A	60	12,000	50	42302161	46074

Continued on next page

D [Inch]	T [Inch]	Abrasive	Grit size	Opt. RPM		Item no.	EDP no.
5/8	1	A	150	12,000	50	42302162	46075
			280	12,000	50	42302163	46076
Silicon carbide SiC-COOL							
3/16	7/16	SiC-COOL	80	40,000	50	42302054	46101
			150	40,000	50	42302055	46102
9/32	1/2	SiC-COOL	80	30,000	50	42302074	46104
			150	30,000	50	42302075	46105
3/8	5/8	SiC-COOL	80	20,000	50	42302104	46107
			150	20,000	50	42302105	46108
1/2	11/16	SiC-COOL	80	16,000	50	42302134	46110
			150	16,000	50	42302135	46111
5/8	1	SiC-COOL	80	12,000	50	42302164	46113
			150	12,000	50	42302165	46114
CO-COOL							
3/16	7/16	CO-COOL	80	40,000	50	42302056	46116
			120	40,000	50	42302057	46117
9/32	1/2	CO-COOL	80	30,000	50	42302076	46119
			120	30,000	50	42302077	46120
3/8	5/8	CO-COOL	80	20,000	50	42302106	46122
			120	20,000	50	42302107	46123
1/2	11/16	CO-COOL	80	16,000	50	42302136	46125
			120	16,000	50	42302137	46126
5/8	1	CO-COOL	80	12,000	50	42302166	46128
			120	12,000	50	42302167	46129



Matching POLICAP® abrasive cap holder in cylindrical shape C with radius end

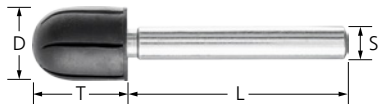

Matching POLICAP® abrasive cap holder in cylindrical shape C with radius end.

Cylindrical with radius end, shape C holders

Special features:

- Abrasive caps and cones fit securely on the holder as it expands during use.

- Easy product change.

D [Inch]	T [Inch]	S [Inch]	L [Inch]	Max. RPM		Item no.	EDP no.
3/16	7/16	1/8	1-1/4	95,000	5	42153100	42011
9/32	1/2	1/8	1-1/4	65,000	5	42153105	42012
3/8	5/8	1/8	1-1/4	45,000	5	42153110	42013
1/2	11/16	1/4	1-5/8	35,000	5	42154115	42023
5/8	1	1/4	1-5/8	30,000	5	42154120	42024



Cylindrical with radius end, shape C set

110-piece set of various POLICAP® abrasive caps with matching holders in cylindrical shape C with radius end.



Contents:

Contents: 105 pieces POLICAP® abrasive caps, 5 pieces POLICAP® abrasive cap holders, see table for details.

Special features:

- Abrasive caps and cones fit securely on the holder as it expands during use.
- Consistent shape accuracy and excellent fine grinding due to special manufacturing.
- Easy product change.

Shape	L [Inch]	B [Inch]	H [Inch]		Item no.	EDP no.
C	7	5-3/4	1-1/2	1	49601103	46094

POLICAP® Cylindrical with pointed cone end, shape G



Cylindrical with pointed cone end, shape G

POLICAP® abrasive caps in tapered conical shape with radius end with aluminum oxide A as the abrasive. The taper angle of the cone is 30°. They have a seamless design, and the entire surface can be used. Optimally matched, reusable holders are available.

Special features:

- The abrasive caps are firmly held in place on the holder as the holder expands during use, plus easy product changing.
- Consistent shape accuracy and excellent fine grinding due to special manufacturing.
- Optimally matched, reusable holders are available. The holder must be ordered separately.

D [Inch]	T [Inch]	Abrasive	Grit size	Opt. RPM		Item no.	EDP no.
3/16	7/16	A	80	40,000	50	42303051	46047
			150	40,000	50	42303052	46048
			280	40,000	50	42303053	46049
9/32	1/2	A	60	30,000	50	42303071	46050
			150	30,000	50	42303072	46051
			280	30,000	50	42303073	46052
3/8	5/8	A	60	20,000	50	42303101	46053
			150	20,000	50	42303102	46054
			280	20,000	50	42303103	46055
1/2	11/16	A	60	16,000	50	42303131	46077
			150	16,000	50	42303132	46078
			280	16,000	50	42303133	46079
5/8	1	A	60	12,000	50	42303161	46080
			150	12,000	50	42303162	46081
			280	12,000	50	42303163	46082



Matching POLICAP® abrasive cap holder in tapered shape G with radius end

Cylindrical with pointed cone end, shape G holders.

Special features:

- Abrasive caps and cones fit securely on the holder as it expands during use.

- Easy product change.

D [Inch]	T [Inch]	S [Inch]	L [Inch]	Max. RPM		Item no.	EDP no.
3/16	7/16	1/8	1-1/4	95,000	5	42153200	42014
9/32	1/2	1/8	1-1/4	65,000	5	42153205	42015
3/8	5/8	1/8	1-1/4	45,000	5	42153210	42016
1/2	11/16	1/4	1-5/8	35,000	5	42154215	42025
5/8	1	1/4	1-5/8	30,000	5	42154220	42026

POLICAP® set, cylindrical with pointed cone end, shape G

Cylindrical with pointed cone end, shape G set

110-piece set of various POLICAP® abrasive caps with matching holders in tapered conical shape G with radius end.

Contents:

Contents: 105 pieces POLICAP® abrasive caps, 5 pieces POLICAP® abrasive cap holders, see table for details.

- Easy product change.

Special features:

- Abrasive caps and cones fit securely on the holder as it expands during use.
- Consistent shape accuracy and excellent fine grinding due to special manufacturing.

Shape	L [Inch]	B [Inch]	H [Inch]		Item no.	EDP no.
G	7	5-3/4	1-1/2	1	49601107	46095



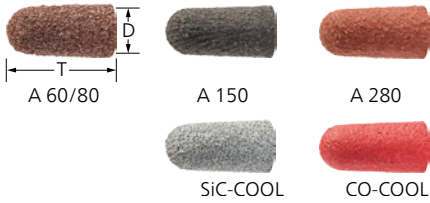

Tapered with radius end, shape L

POLICAP® abrasive caps in conical shape with radius end. Available in aluminum oxide A, silicon carbide SiC-COOL and ceramic oxide grain CO-COOL. They have a seamless design and the entire tool surface can be used. Optimally matched, reusable holders are available.



Special features:

- The abrasive caps are firmly held in place on the holder as the holder expands during use, plus easy product changing.
- Consistent shape accuracy and excellent fine grinding due to special manufacturing.
- Optimally matched, reusable holders are available. The holder must be ordered separately.



D [Inch]	T [Inch]	Abrasive	Grit size	Opt. RPM		Item no.	EDP no.
Aluminum oxide A							
1/4	5/8	A	80	40,000	50	42306051	46083
			150	40,000	50	42306052	46084
			280	40,000	50	42306053	46085
7/16	1	A	60	20,000	50	42306111	46056
			150	20,000	50	42306112	46057
			280	20,000	50	42306113	46058
5/8	1-1/4	A	60	12,000	50	42306161	46059
			150	12,000	50	42306162	46060
			280	12,000	50	42306163	46061
27/32	1-9/16	A	60	9,500	50	42306211	46062
			150	9,500	50	42306212	46063
			280	9,500	50	42306213	46064
Silicon carbide SiC-COOL							
1/4	5/8	SiC-COOL	80	40,000	50	42306054	46131
			150	40,000	50	42306055	46132
7/16	1	SiC-COOL	80	20,000	50	42306114	46134
			150	20,000	50	42306115	46135
5/8	1-1/4	SiC-COOL	80	12,000	50	42306164	46137
			150	12,000	50	42306165	46138
27/32	1-9/16	SiC-COOL	80	9,500	50	42306214	46140
			150	9,500	50	42306215	46141
CO-COOL							
1/4	5/8	CO-COOL	80	40,000	50	42306056	46143
			120	40,000	50	42306057	46144
7/16	1	CO-COOL	80	20,000	50	42306116	46146
			120	20,000	50	42306117	46147
5/8	1-1/4	CO-COOL	80	12,000	50	42306166	46149
			120	12,000	50	42306167	46150
27/32	1-9/16	CO-COOL	80	9,500	50	42306216	46152
			120	9,500	50	42306217	46153

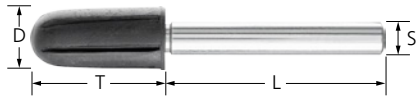

Matching POLICAP® abrasive cap holder in conical shape L with radius end

Tapered with radius end, shape L holders.

Special features:

- Abrasive caps and cones fit securely on the holder as it expands during use.
- Easy product change.

D [Inch]	T [Inch]	S [Inch]	L [Inch]	Max. RPM		Item no.	EDP no.
1/4	5/8	1/4	1-5/8	95,000	5	42154400	42017
7/16	1	1/4	1-5/8	40,000	5	42154410	42018
5/8	1-1/4	1/4	1-5/8	30,000	5	42154420	42019
27/32	1-9/16	1/4	1-5/8	20,000	5	42154430	42020



SET PCS 650

Set of various POLICAP® abrasive caps with matching holder in sturdy, reusable packaging.



one each of the following POLICAP® abrasive cap holders: PCT ZYA 0510/3, PCT ZYA 0712/3, PCT ZYA 1015/3, PCT ZYA 1317/6, PCT ZYA 1626/6, PCT WKG 0511/3, PCT WKG 0713/3, PCT WKG 1015/3, PCT WKG 1317/6 and PCT WKG 1626/6.

Special features:

- Abrasive caps and cones fit securely on the holder as it expands during use.
- Consistent shape accuracy and excellent fine grinding due to special manufacturing.
- Easy product change.

Contents:

Contents PCS 650: 640 pieces POLICAP® abrasive caps; 10 pieces POLICAP® abrasive cap holders (see table for details)

Shape	L [Inch]	B [Inch]	H [Inch]		Item no.	EDP no.
A, G	13	9-1/4	2	1	49606500	46091





SET PCS 285

Set of various POLICAP® abrasive caps with matching holder in sturdy, reusable packaging.

Contents:

Six each of POLICAP® abrasive caps in shape A - EDP 46029, 46030, 46031, 46032, 46033, 46034, 46035, 46036, 46037, 46065, 46066, 46067, 46068, 46069, 46070. Six each of POLICAP® abrasive caps in shape C - EDP 46038, 46039, 46040, 46041, 46042, 46043, 46044, 46045, 46046, 46071, 46072, 46073, 46074, 46075, 46076. Six each of POLICAP® abrasive caps in shape G - EDP 46047, 46048, 46049, 46050, 46051, 46052, 46053, 46054, 46055, 46077, 46078, 46079, 46080, 46081, 46082.

One each of POLICAP® abrasive caps holder - EDP 42011, 42012, 42013, 42014, 42015, 42016, 42023, 42024, 42025, 42026.

Special features:

- Abrasive caps and cones fit securely on the holder as it expands during use.
- Consistent shape accuracy and excellent fine grinding due to special manufacturing.
- Easy product change.

Shape	L [Inch]	B [Inch]	H [Inch]		Item no.	EDP no.
A, C, G	13	9-1/4	2	1	47101038	46090

POLICAP® abrasive cones, conical shape L

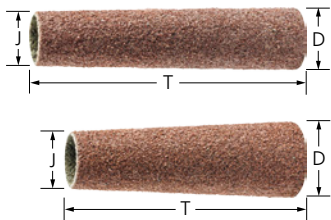

Abrasive cones, conical shape L

POLICAP® abrasive cones in conical shape with aluminum oxide A. They have a seamless design and the entire tool surface can be used. Optimally matched, reusable holders are available.

Special features:

- The abrasive caps are firmly held in place on the holder as the holder expands during use, plus easy product changing.
- Consistent shape accuracy and excellent fine grinding due to special manufacturing.
- Optimally matched, reusable holders are available. The holder must be ordered separately.

D [Inch]	J [Inch]	T [mm]	Abrasive	Grit size	Opt. RPM		Item no.	EDP no.
9/32	3/16	3-3/8	A	60	12,000	10	42330052	46008
				150	12,000	10	42330054	46009
				280	12,000	10	42330056	46010
1/2	7/16	3-3/8	A	60	12,000	10	42330112	46011
				150	12,000	10	42330114	46012
3/4	1/2	2-1/2	A	60	18,500	10	42333012	46020
				150	18,500	10	42333014	46021
	5/8	3-3/8	A	60	12,000	10	42330162	46014
				150	12,000	10	42330164	46015
15/16	3/4	3-3/8	A	60	12,000	10	42330212	46017
				150	12,000	10	42330214	46018
1-3/8	7/8	2-3/8	A	60	13,000	10	42333212	46023



Matching POLICAP® rubber abrasive tapered cone holder, cylindrical shape L

Matching POLICAP® abrasive cap holder in conical shape L with radius end

Special features:

- Abrasive caps and cones fit securely on the holder as it expands during use.

D [Inch]	T [Inch]	S [Inch]	L [Inch]	Max. RPM		Item no.	EDP no.
5/16	3-3/8	1/4	1-5/8	20,000	5	42154405	42001
1/2	3-3/8	1/4	1-5/8	15,000	5	42154415	42002
3/4	3-3/8	1/4	1-5/8	13,000	5	42154425	42003
7/8	3-3/8	1/4	1-5/8	12,000	5	42154435	42004



Quick product selection guide

			Abrasive ▶			
Material group ▼			Aluminum oxide A	Zirconia alumina Z-COOL	Ceramic oxide grain CO-COOL	Silicon carbide SiC-COOL
Steel, cast steel	Non-hardened, non-heat-treated steels	Construction steels, carbon steels, tool steels, non-alloyed steels, cast steel	●	○	○	
	Hardened, heat-treated steels	Tool steels, tempering steels, alloyed steels, cast steel	○	●	●	
Stainless steel (INOX)	Rust and acid-resistant steels	Austenitic and ferritic stainless steels		●	●	
Non-ferrous metals	Soft non-ferrous metals, non-ferrous metals	Soft aluminum alloys	○			●
		Brass, copper, zinc	●	○	○	
	Hard non-ferrous metals	Hard aluminum alloys	○			●
		Bronze, titanium		○	○	●
	High-temperature-resistant materials	Nickel-based and cobalt-based alloys		○	●	
Cast iron	Grey cast iron, white cast iron	Cast iron with flake graphite, with nodular graphite/nodular cast iron, white annealed cast iron, black annealed cast iron	●	○	●	
Plastics, other materials		Fibre-reinforced plastics, thermoplastics, wood, chipboard, paintwork	○			●

● = highly recommended ○ = recommended

Safety notes

- For safety reasons, the maximum permitted rotational speed indicated must never be exceeded.
- The contact pressure has to be reduced significantly when the optimum rotational speed is exceeded.
- Safety is only guaranteed when: The clamping depth is at least 5/8. The specified maximum rotational speed is not exceeded with unsupported shank lengths.

 Wear eye protection!

 Wear hearing protection!

 Wear gloves!

 Wear a dust mask!

 Follow the safety instructions!



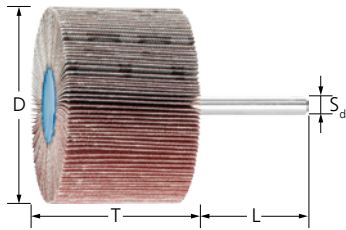

Aluminum oxide A

The flaps made of coated abrasive are arranged radially around the axis in a fan-type structure. For general applications from coarse to fine grinding.

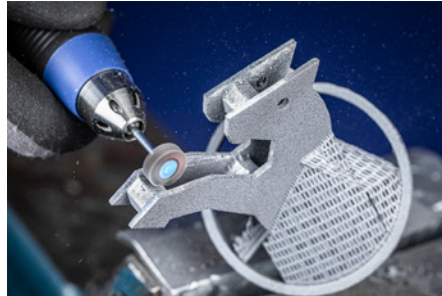

Special features:

- Conforms to contours due to high flexibility.
- Consistently high stock removal rate throughout the entire service life as new, aggressive abrasive is constantly exposed.
- Can be used face-down very close to edges and in corners due to the flat, molded-core design.

D [Inch]	T [Inch]	Abrasive	Grit size	Opt. RPM	Max. RPM		Item no.	EDP no.
Shank diameter 1/8" x 1-1/2" [S_d x L]								
3/8	3/8	A	60	38,000	75,000	10	47802433	45070
			80	38,000	75,000	10	47802434	45071
			120	38,000	75,000	10	47802435	45072
			180	38,000	75,000	10	47802436	45074
			240	38,000	75,000	10	47802437	45075
	5/8	A	60	38,000	75,000	10	47802439	45077
			80	38,000	75,000	10	47802440	45078
			120	38,000	75,000	10	47802441	45079
			180	38,000	75,000	10	47802442	45081
			240	38,000	75,000	10	47802443	45082
5/8	3/8	A	60	25,000	50,000	10	47802451	45091
			80	25,000	50,000	10	47802452	45092
			120	25,000	50,000	10	47802453	45093
			180	25,000	50,000	10	47802454	45095
			240	25,000	50,000	10	47802455	45096
	5/8	A	60	25,000	50,000	10	47802457	45098
			80	25,000	50,000	10	47802458	45099
			120	25,000	50,000	10	47802459	45100
			180	25,000	50,000	10	47802460	45102
			240	25,000	50,000	10	47802461	45103
3/4	3/8	A	60	19,000	38,100	10	47801641	45154
			80	19,000	38,100	10	47801642	45155
			120	19,000	38,100	10	47801643	45156
			180	19,000	38,100	10	47801644	45157
			240	19,000	38,100	10	47802540	45158
1	1	A	60	15,000	25,400	10	47801257	45178
			80	15,000	25,400	10	47801258	45179
			120	15,000	25,400	10	47801259	45180
			180	15,000	25,400	10	47801595	45181
			240	15,000	25,400	10	47801261	45182
1-3/16	3/8	A	60	12,000	25,400	10	47801280	45013
			80	12,000	25,400	10	47801281	45014
			120	12,000	25,400	10	47801282	45015
			180	12,000	25,400	10	47801283	45016
			240	12,000	25,400	10	47801485	45017

Continued on next page



Flap wheels

Mounted flap wheels



D [Inch]	T [Inch]	Abrasive	Grit size	Opt. RPM	Max. RPM		Item no.	EDP no.				
Shank diameter 1/4" x 1-1/2" [S_d x L]												
3/4	3/8	A	60	19,000	38,100	10	47801645	45160				
			80	19,000	38,100	10	47801646	45161				
			120	19,000	38,100	10	47801647	45162				
1	5/8	A	60	15,000	25,000	10	47801246	45172				
			80	15,000	25,000	10	47801247	45173				
			120	15,000	25,000	10	47801248	45174				
			180	15,000	25,000	10	47801594	45175				
	1	1	A	40	15,000	25,000	10	47801659	45463			
				60	15,000	25,000	10	47801263	45184			
				80	15,000	25,000	10	47801264	45185			
				120	15,000	25,000	10	47801265	45186			
				180	15,000	25,000	10	47801596	45187			
				240	15,000	25,000	10	47801267	45188			
				320	15,000	25,000	10	47801268	45189			
				60	12,000	25,000	10	47801275	45007			
				80	12,000	25,000	10	47801276	45008			
				120	12,000	25,000	10	47801277	45009			
1-3/8	5/8	A	60	10,900	23,000	10	47801286	45226				
			80	10,900	23,000	10	47801287	45227				
			120	10,900	23,000	10	47801288	45228				
			180	10,900	23,000	10	47801600	45229				
			240	10,900	23,000	10	47801289	45230				
1-1/2	1/2	A	40	9,600	23,000	10	47800149	45244				
			60	9,600	23,000	10	47801294	45245				
			80	9,600	23,000	10	47801295	45246				
			120	9,600	23,000	10	47801296	45247				
	1-1/2	1	A	60	9,600	23,000	10	47801304	45232			
				80	9,600	23,000	10	47801305	45233			
				120	9,600	23,000	10	47801306	45234			
				180	9,600	23,000	10	47801601	45235			
				240	9,600	23,000	10	47801308	45236			
				320	9,600	23,000	10	47801309	45237			
				2	1/2	A	60	7,000	23,000	10	47801316	45251
							80	7,000	23,000	10	47801317	45252
							120	7,000	23,000	10	47801318	45253
					3/4	A	60	7,000	23,000	10	47801358	45258
80	7,000	23,000	10				47801359	45259				
120	7,000	23,000	10				47801360	45260				
180	7,000	23,000	10				47801603	45261				
60	7,000	23,000	10				47801326	45461				
1	A	60	7,000		23,000	10	47801327	45238				
		80	7,000		23,000	10	47801328	45239				
		120	7,000		23,000	10	47801329	45240				
		180	7,000		23,000	10	47801330	45241				
		240	7,000		23,000	10	47801331	45242				
		320	7,000		23,000	10	47801332	45243				
		1-1/2	A	60	7,000	15,000	10	47801349	45190			
80	7,000			15,000	10	47801350	45191					
120	7,000			15,000	10	47801351	45192					

Continued on next page

D [Inch]	T [Inch]	Abrasive	Grit size	Opt. RPM	Max. RPM		Item no.	EDP no.
2-1/2	1/2	A	60	6,300	23,000	10	47801364	45264
			80	6,300	23,000	10	47801365	45265
			120	6,300	23,000	10	47801366	45266
			40	6,300	23,000	10	47800150	45305
	1	A	60	6,300	23,000	10	47801375	45270
			80	6,300	23,000	10	47801376	45271
			120	6,300	23,000	10	47801377	45272
			180	6,300	23,000	10	47801604	45273
			240	6,300	23,000	10	47801379	45274
			320	6,300	23,000	10	47801380	45275
	1-1/2	A	40	6,300	13,000	10	47800151	45306
			60	6,300	13,000	10	47801387	45276
80			6,300	13,000	10	47801388	45277	
120			6,300	13,000	10	47801389	45278	
3	1/2	A	40	4,800	20,000	10	47800152	45220
			60	4,800	20,000	10	47801390	45196
			80	4,800	20,000	10	47801391	45197
			120	4,800	20,000	10	47801392	45198
	1	A	40	4,800	20,000	10	47801409	45462
			60	4,800	20,000	10	47801410	45208
			80	4,800	20,000	10	47801411	45209
			120	4,800	20,000	10	47801412	45210
			180	4,800	20,000	10	47801413	45211
			240	4,800	20,000	10	47801414	45212
			320	4,800	20,000	10	47801415	45213
			60	4,800	6,000	10	47801428	45214
	2	A	80	4,800	6,000	10	47801429	45215
			120	4,800	6,000	10	47801430	45216

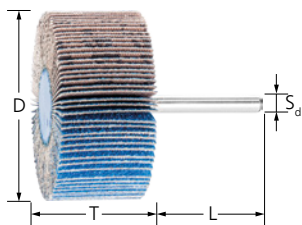

Zirconia alumina Z-COOL

The flaps made of coated abrasive are arranged radially around the axis in a fan-type structure. For coarse grinding work with a high stock removal rate. Active grinding additives substantially improve the stock removal rate, prevent clogging and result in cooler grinding.

Special features:

- Conforms to contours due to high flexibility.
- Consistently high stock removal rate throughout the entire service life as new, aggressive abrasive is constantly exposed.
- Can be used face-down very close to edges and in corners due to the flat, molded-core design.

D [Inch]	T [Inch]	Abrasive	Grit size	Opt. RPM	Max. RPM		Item no.	EDP no.
Shank diameter 1/4" x 1-1/2" [S_d x L]								
1	1	Z-COOL	60	15,000	25,000	10	47801655	45465
			80	15,000	25,000	10	47801656	45466
			120	15,000	25,000	10	47801657	45467
1-1/2	1	Z-COOL	60	9,600	25,000	10	47801314	45469
			80	9,600	25,000	10	47801315	45470
			120	9,600	25,000	10	47801650	45471
2	1	Z-COOL	60	7,000	23,000	10	47801343	45473
			80	7,000	23,000	10	47801344	45474
			120	7,000	23,000	10	47801649	45475

Continued on next page

Flap wheels

Mounted flap wheels



D [Inch]	T [Inch]	Abrasive	Grit size	Opt. RPM	Max. RPM		Item no.	EDP no.
2-1/2	1	Z-COOL	60	7,000	23,000	10	47801651	45477
			80	7,000	23,000	10	47801652	45478
			120	7,000	23,000	10	47801653	45479
	1-1/2	Z-COOL	60	6,300	13,000	10	47800168	45488
			80	6,300	13,000	10	47800169	45489
			120	6,300	13,000	10	47800170	45490
3	1/2	Z-COOL	60	4,800	20,000	10	47800171	45497
			80	4,800	20,000	10	47800172	45498
			120	4,800	20,000	10	47800173	45499
	1	Z-COOL	60	4,800	20,000	10	47801426	45481
			80	4,800	20,000	10	47801427	45482
			120	4,800	20,000	10	47801654	45483

4

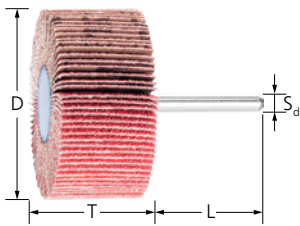

Ceramic oxide grain CO-COOL

The ideal flap wheel for use on angle grinders in assembly shop operations. For aggressive grinding with maximum stock removal rate on hard materials which do not conduct heat well. Consistently high performance due to self-sharpening ceramic oxide grain. Active grinding additives in the coating substantially improve the stock removal rate, prevent loading and result in cooler grinding.

Special features:

- Conforms to contours due to high flexibility.
- Consistently high stock removal rate throughout the entire service life as new, aggressive abrasive is constantly exposed.
- Can be used face-down very close to edges and in corners due to the flat, molded-core design.

D [Inch]	T [Inch]	Abrasive	Grit size	Opt. RPM	Max. RPM		Item no.	EDP no.
Shank diameter 1/4" x 1-1/2" [S_d x L]								
1	1	CO-COOL	40	15,000	25,000	10	47802674	45279
			60	15,000	25,000	10	47802675	45280
			80	15,000	25,000	10	47802676	45281
			120	15,000	25,000	10	47802677	45282
1-1/2	1	CO-COOL	40	9,600	25,000	10	47802678	45284
			60	9,600	25,000	10	47802679	45285
			80	9,600	25,000	10	47802680	45286
			120	9,600	25,000	10	47802681	45287
2	1	CO-COOL	40	7,000	23,000	10	47802682	45289
			60	7,000	23,000	10	47802683	45290
			80	7,000	23,000	10	47802684	45291
			120	7,000	23,000	10	47802685	45292
2-1/2	1	CO-COOL	40	7,000	23,000	10	47800156	45434
			60	7,000	23,000	10	47800157	45435
			80	7,000	23,000	10	47800158	45436
			120	7,000	23,000	10	47800159	45437
	1-1/2	CO-COOL	40	6,300	13,000	10	47800160	45443
			60	6,300	13,000	10	47800161	45444
			80	6,300	13,000	10	47800162	45445
			120	6,300	13,000	10	47800163	45446
3	1/2	CO-COOL	40	4,800	20,000	10	47800164	45456
			60	4,800	20,000	10	47800165	45457
			80	4,800	20,000	10	47800166	45458

Continued on next page

D [Inch]	T [Inch]	Abrasive	Grit size	Opt. RPM	Max. RPM		Item no.	EDP no.
3	1/2	CO-COOL	120	4,800	20,000	10	47800167	45459
	1	CO-COOL	40	4,800	20,000	10	47802804	45294
			60	4,800	20,000	10	47802805	45295
			80	4,800	20,000	10	47802806	45296
			120	4,800	20,000	10	47802807	45297

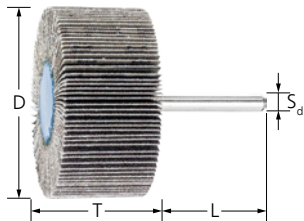

Silicon carbide SiC

The flaps made of coated abrasive are arranged radially around the axis in a fan-type structure. For universal grinding work on components made from aluminum, copper, bronze, titanium and fibre-reinforced plastics. Particularly recommended for use on titanium alloys. Ideally suited to use in the aeronautical industry, especially where SiC is the only approved abrasive, e.g. for use on engine components.



Special features:

- Conforms to contours due to high flexibility.
- Consistently high stock removal rate throughout the entire service life as new, aggressive abrasive is constantly exposed.
- Can be used face-down very close to edges and in corners due to the flat, molded-core design.

D [Inch]	T [Inch]	Abrasive	Grit size	Opt. RPM	Max. RPM		Item no.	EDP no.
Shank diameter 1/4" x 1-1/2" [S_d x L]								
1	1/2	SiC	60	15,000	25,000	10	47800174	45415
			80	15,000	25,000	10	47800175	45416
			120	15,000	25,000	10	47800176	45417
	1	SiC	60	15,000	25,000	10	47801672	45485
			80	15,000	25,000	10	47801673	45486
			120	15,000	25,000	10	47801674	45487
2	1/2	SiC	60	7,000	23,000	10	47800177	45426
			80	7,000	23,000	10	47800178	45427
			120	7,000	23,000	10	47800179	45428
	1	SiC	60	7,000	23,000	10	47801340	45491
			80	7,000	23,000	10	47801341	45492
			120	7,000	23,000	10	47801342	45493
3	1/2	SiC	60	4,800	20,000	10	47800180	45429
			80	4,800	20,000	10	47800181	45438
			120	4,800	20,000	10	47800182	45439
	1	SiC	60	4,800	20,000	10	47801423	45494
			80	4,800	20,000	10	47801424	45495
			120	4,800	20,000	10	47801425	45496



Flap wheels

Threaded mounted flap wheel

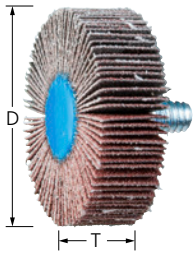

Aluminum oxide A

The flaps made of coated abrasive are arranged radially around the axis in a fan-type structure. For general applications from coarse to fine grinding.

Special features:

- Conforms to contours due to high flexibility.
- Consistently high stock removal rate throughout the entire service life as new, aggressive abrasive is constantly exposed.
- Can be used face-down very close to edges and in corners due to the flat, molded-core design.

D [Inch]	T [Inch]	Thread	Abrasive	Grit size	Opt. RPM	Max. RPM		Item no.	EDP no.				
1	5/8	1/4-20	A	60	15,000	25,000	10	47801252	45300				
				80	15,000	25,000	10	47801253	45301				
				120	15,000	25,000	10	47801254	45302				
	1	1/4-20	A	40	15,000	25,000	10	47800153	45316				
				60	15,000	25,000	10	47801269	45310				
				80	15,000	25,000	10	47801270	45311				
				120	15,000	25,000	10	47801271	45312				
180				15,000	25,000	10	47801272	45313					
240				15,000	25,000	10	47801273	45314					
1-1/2				1/2	1/4-20	A	60	9,600	23,000	10	47801300	45330	
	80	9,600	23,000				10	47801301	45331				
	120	9,600	23,000				10	47801302	45332				
	1	1/4-20	A	40	9,600	23,000	10	47800155	45318				
				60	9,600	23,000	10	47801310	45340				
				80	9,600	23,000	10	47801311	45341				
				120	9,600	23,000	10	47801312	45342				
				2	1/2	1/4-20	A	60	7,000	23,000	10	47801322	45350
								80	7,000	23,000	10	47801323	45351
								120	7,000	23,000	10	47801324	45352
2-1/2	1	1/4-20	A	40	7,000	23,000	10	47801333	45369				
				60	7,000	23,000	10	47801334	45370				
				80	7,000	23,000	10	47801335	45371				
				120	7,000	23,000	10	47801336	45372				
				180	7,000	23,000	10	47801337	45373				
				240	7,000	23,000	10	47801338	45374				
				1/2	1/4-20	A	60	6,300	23,000	10	47801370	45410	
	80	6,300	23,000				10	47801371	45411				
	120	6,300	23,000				10	47801372	45412				
	3	1/2	1/4-20	A	60	6,300	23,000	10	47801381	45420			
80					6,300	23,000	10	47801382	45421				
120					6,300	23,000	10	47801383	45422				
180					6,300	23,000	10	47801384	45423				
1					1/4-20	A	40	4,800	20,000	10	47800154	45317	
							60	4,800	20,000	10	47801396	45430	
		80	4,800	20,000			10	47801397	45431				
		120	4,800	20,000			10	47801398	45432				
1		1/4-20	A	40	4,800	20,000	10	47801416	45449				
				60	4,800	20,000	10	47801417	45450				
	80			4,800	20,000	10	47801418	45451					
	120			4,800	20,000	10	47801419	45452					
	180			4,800	20,000	10	47801420	45453					



Threaded shank adapter

Shank adapter for mounted flap wheels with male thread 1/4-20.

S [Inch]		Item no.	EDP no.
1/4	1	47601300	49986
	10	33700150	45299

Mounted flap wheel – bore polisher

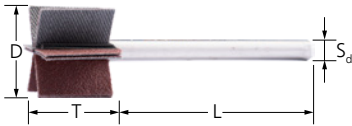

Aluminum oxide A

The flaps made of coated abrasive are arranged radially around the axis in a fan-type structure. Designed for fine grinding.

Special features:

- Consistently high stock removal rate throughout the entire service life as new, aggressive abrasive is constantly exposed.
- Conforms to contours due to high flexibility.

D [Inch]	T [Inch]	Abrasive	Grit size	Opt. RPM	Max. RPM		Item no.	EDP no.
5/8	3/4	A	120	25,400	31,800	10	47803433	46410
			150	25,400	31,800	10	47803434	46411
3/4	3/4	A	120	19,100	23,800	10	47803435	46412
			150	19,100	23,800	10	47803436	46413
1	3/4	A	120	15,000	19,100	10	47803437	46414
			150	15,000	19,100	10	47803438	46415
1-1/8	3/4	A	120	12,700	15,900	10	47803439	46416
			150	12,700	15,900	10	47803440	46417

Unmounted flap wheels and accessories

Safety notes

- Unmounted flap wheels should only be used with the appropriate clamping flanges.
- The maximum permitted peripheral speed is defined as follows: Unmounted flap wheels = 9,800 SFPM; Unmounted flap wheels for angle grinders = 15,800 SFPM; Flap drums = 6,300 SFPM
- The contact pressure has to be reduced significantly when the optimum rotational speed is exceeded.
- For safety reasons, the maximum permitted rotational speed indicated must never be exceeded.



Wear eye protection!



Wear hearing protection!



Wear gloves!



Wear a dust mask!



Follow the safety instructions!

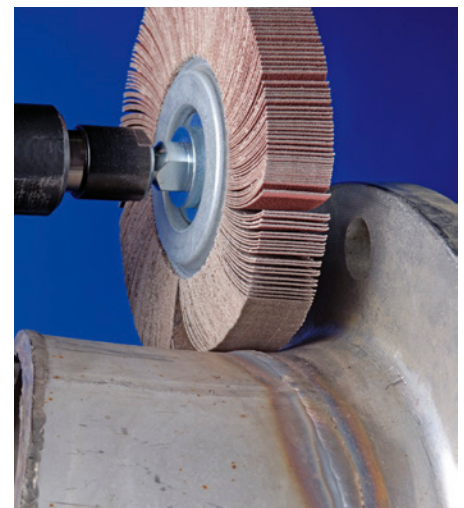

Flap wheels

Unmounted flap wheels and accessories

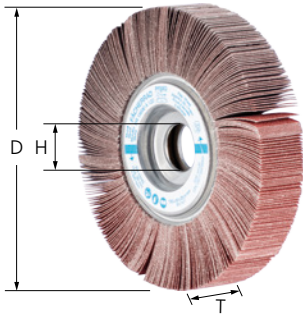

Aluminum oxide A

The flaps made of coated abrasive are arranged radially around the axis in a fan-type structure. For general applications from coarse to fine grinding.

Special features:

- Optimum adaptation to contours due to high flexibility. Face-down use very close to edges and in corners is possible due to the special clamping system.
- Consistently high stock removal rate throughout the entire service life as new, aggressive abrasive is constantly exposed.

- Please order compatible arbor separately.

D [Inch]	T [Inch]	H [Inch]	Abrasive	Grit size	Opt. RPM	Max. RPM		Item no.	EDP no.	
4	1	1	A	40	5,500	9,500	2	44710041	45530	
				60	5,500	9,500	2	44710061	45532	
				80	5,500	9,500	2	44710081	45533	
				120	5,500	9,500	2	44710121	45535	
				180	5,500	9,500	2	47801822	45536	
	2	1	A	60	5,500	9,500	2	44712061	45552	
				80	5,500	9,500	2	44712081	45553	
				120	5,500	9,500	2	44712121	45555	
	6	1	1	A	40	3,500	6,300	2	44724040	45600
					60	3,500	6,300	2	44724060	45602
80					3,500	6,300	2	44724080	45603	
120					3,500	6,300	2	44724120	45605	
180					3,500	6,300	2	47801926	45607	
1-1/2		1	A	40	3,500	6,300	2	47801929	45610	
				60	3,500	6,300	2	47802109	45612	
				80	3,500	6,300	2	47801932	45613	
2		1	A	40	3,500	6,300	2	44726040	45620	
				60	3,500	6,300	2	44726060	45622	
				80	3,500	6,300	2	44726080	45623	
				120	3,500	6,300	2	44726120	45625	
				180	3,500	6,300	2	47802429	45626	
				240	3,500	6,300	2	44726240	45627	
8		1	1-3/4	A	60	2,600	4,700	2	44736061	45642
					80	2,600	4,700	2	44736081	45643
					120	2,600	4,700	2	44736121	45645
		2	1-3/4	A	60	2,600	4,700	2	44738061	45652
	80				2,600	4,700	2	44738081	45653	
	120				2,600	4,700	2	44738121	45655	

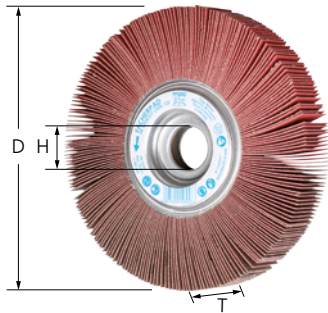

Ceramic oxide grain CO-COOL

For aggressive grinding with maximum stock removal rate on hard materials which do not conduct heat well. Consistently high performance due to self-sharpening ceramic oxide grain. Active grinding additives in the coating substantially improve the stock removal rate, prevent loading and result in cooler grinding.

Special features:

- Optimum adaptation to contours due to high flexibility. Face-down use very close to edges and in corners is possible due to the special clamping system.
- Consistently high stock removal rate throughout the entire service life as new, aggressive abrasive is constantly exposed.
- Please order compatible arbor separately.

D [Inch]	T [Inch]	H [Inch]	Abrasive	Grit size	Opt. RPM	Max. RPM		Item no.	EDP no.
6	1	1	CO-COOL	40	3,500	6,300	2	44725204	45840
				60	3,500	6,300	2	44725206	45841
				80	3,500	6,300	2	44725208	45842
				120	3,500	6,300	2	44725212	45843
	2	1	CO-COOL	40	3,500	6,300	2	44727204	45844
				60	3,500	6,300	2	44727206	45845
				80	3,500	6,300	2	44727208	45846
				120	3,500	6,300	2	44727212	45847



Arbor

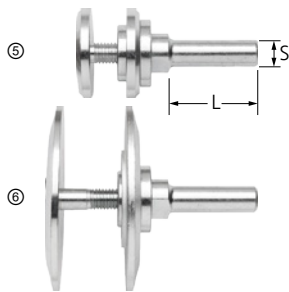

Clamping flanges for unmounted flap wheels

For mounting PFERD unmounted flap wheels. The clamping flanges are designed to lie counter-sunk in the wheel.

Special features:

- Can be used face-down very close to edges and in corners thanks to special clamping system.

Image	Suitable for hole diameter [Inch]	S [Inch]	L [Inch]	Clamping width [Inch]		Item no.	EDP no.
(5)	1	1/2	1-1/2	1 – 2	1	47601151	45714
(6)	1-3/4	1/2	1-1/2	1 – 3	1	47601152	45715

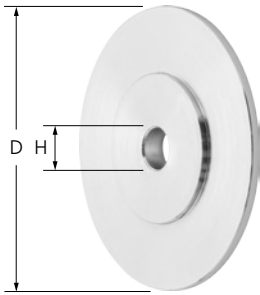

Reducing flanges for unmounted flap wheels

For mounting unmounted flap wheels and POLINOX® grinding wheels on drive spindles. The clamping flanges are designed to lie countersunk in the tool.

Special features:

- Can be used face-down very close to edges and in corners thanks to special clamping system.
- Can be adapted to an existing drive spindle by drilling.

Suitable for tool diameter [Inch]	D [Inch]	H [Inch]	Max. H [Inch]		Item no.	EDP no.
4-6	1-1/2	1/2	7/8	1	47601153	45720
		5/8	7/8	1	47601154	45721
		3/4	7/8	1	47601155	45722
8-10	3-5/32	1/2	1-1/2	1	47601156	45725
		5/8	1-1/2	1	47601157	45726
		3/4	1-1/2	1	47601158	45727
		1	1-1/2	1	47601159	45728

Flap wheels for angle grinders



Aluminum oxide A

The flaps made of coated abrasive are arranged radially around the axis in a fan-type structure. For general applications from coarse to fine grinding.

Special features:

- Can be mounted directly on the angle grinder without additional clamping devices.
- Consistently high stock removal rate throughout the entire service life as new, aggressive abrasive is constantly exposed.
- Can be used face-down very close to edges and in corners. Highly flexible, enabling optimal adjustment to the contour.

D [Inch]	T [Inch]	Thread	Abrasive	Grit size	Opt. RPM	Max. RPM		Item no.	EDP no.
4-1/2	3/4	5/8-11	A	40	7,500	13,300	2	47802558	45751
				60	7,500	13,300	2	47802559	45753
				80	7,500	13,300	2	47802560	45754
				120	7,500	13,300	2	47802561	45755
				180	7,500	13,300	2	47802821	45757
				240	7,500	13,300	2	47802822	45758
				320	7,500	13,300	2	47802823	45759
5	3/4	5/8-11	A	40	6,850	12,200	2	47802663	45761
				60	6,850	12,200	2	47802664	45763
				80	6,850	12,200	2	47802665	45764
				120	6,850	12,200	2	47802666	45765
				180	6,850	12,200	2	47802824	45767
				240	6,850	12,200	2	47802825	45768
				320	6,850	12,200	2	47802826	45769

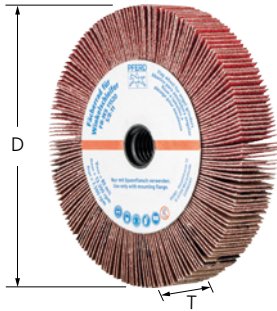

Ceramic oxide grain CO-COOL

The ideal flap wheel for use on angle grinders in assembly shop operations. For aggressive grinding with maximum stock removal rate on hard materials which do not conduct heat well. Consistently high performance due to self-sharpening ceramic oxide grain. Active grinding additives in the coating substantially improve the stock removal rate, prevent loading and result in cooler grinding.

Special features:

- Can be mounted directly on the angle grinder without additional clamping devices.
- Consistently high stock removal rate throughout the entire service life as new, aggressive abrasive is constantly exposed.
- Can be used face-down very close to edges and in corners. Highly flexible, enabling optimal adjustment to the contour.

D [Inch]	T [Inch]	Thread	Abrasive	Grit size	Opt. RPM	Max. RPM		Item no.	EDP no.
4-1/2	3/4	5/8-11	CO-COOL	40	7,500	13,300	2	44781804	45740
				60	7,500	13,300	2	44781806	45741
				80	7,500	13,300	2	44781808	45742
				120	7,500	13,300	2	44781812	45743
5	3/4	5/8-11	CO-COOL	40	6,850	12,200	2	44782804	45744
				60	6,850	12,200	2	44782806	45745
				80	6,850	12,200	2	44782808	45746
				120	6,850	12,200	2	44782812	45747



Flap drums

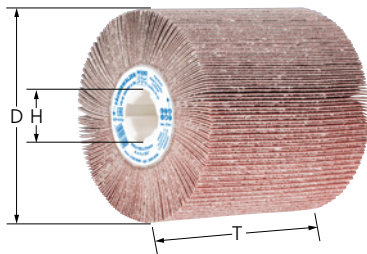

Aluminum oxide A

For universal work on medium-sized and large metallic surfaces, e.g. fine grinding work on large radii in container, food service and apparatus construction, and achieving consistent linear scratch patterns on large surfaces and contours in manual applications.

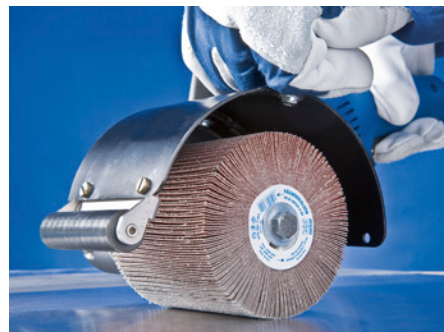

Special features:

- The 3/4" center hole diameter with 4 keyways fits all conventional drum grinders.
- Consistently high stock removal rate throughout the entire service life as new, aggressive abrasive is constantly exposed.
- Face-down use very close to edges and in corners is possible due to the special clamping system.

D [Inch]	T [Inch]	H [Inch]	Abrasive	Grit size	Opt. RPM	Max. RPM		Item no.	EDP no.
4	4	3/4	A	40	3,800	6,100	1	44783040	45780
				60	3,800	6,100	1	44783060	45781
				80	3,800	6,100	1	44783080	45782
				120	3,800	6,100	1	44783120	45783
				150	3,800	6,100	1	44783150	45784
				180	3,800	6,100	1	44783180	45785

Flap wheels

General information – POLIFLAP® system

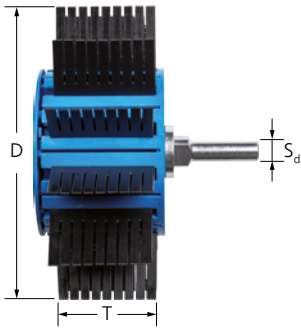

POLIFLAP® wheel

The wheel consists of a shank-mounted support and rubber flaps. It must be completed with appropriate abrasive flaps. The customized arrangement of abrasive and rubber flaps results in a highly versatile product.

Special features:

- Ideal for blending and restoring surface textures, fine grinding of radii, contours, curved areas or large surfaces.
- Creates a consistently high surface quality throughout the entire service life, as new sharp abrasive material is constantly exposed.

- Comfortable to use due to particularly light-weight design. Supplied without abrasive flaps. Please order abrasive flaps separately in the desired grit size.

D [Inch]	T [Inch]	S _d [Inch]	Opt. RPM	Max. RPM		Item no.	EDP no.
7	2-3/8	3/8	1,500	3,500	1	47101121	45950

4

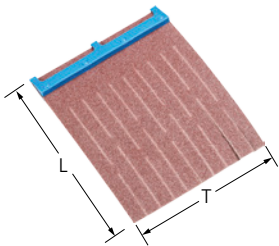

POLIFLAP® abrasive flaps

Abrasive flaps for POLIFLAP® grinding wheels, for achieving visual effects ranging from coarse to very fine.



Special features:

- Ideal for blending and restoring surface textures, fine grinding of radii, contours, curved areas or large surfaces.
- Comfortable to use and easy to replace once worn.

L [Inch]	T [mm]	Abrasive	Grit size		Item no.	EDP no.
2-3/4	2-3/8	A	60	12	42800110	45960
			80	12	42800111	45961
			100	12	42800112	45962
			120	12	42800113	45963
			150	12	42800114	45964
			180	12	42800115	45965
			220	12	42800116	45966
			320	12	42800117	45968

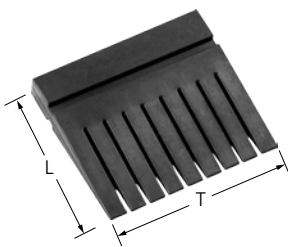

POLIFLAP® rubber flaps

Rubber flaps to match the POLIFLAP® grinding wheel. They lie between the abrasive flaps, and support the abrasive effect and the flexibility of the system.

Special features:

- Comfortable to use and easy to replace once worn.
- The package contains a complete POLIFLAP® grinding wheel.

L [Inch]	T [Inch]		Item no.	EDP no.
2	2-1/6	12	42800120	45951

Safety notes

- For safety reasons, the maximum permitted rotational speed indicated must never be exceeded.

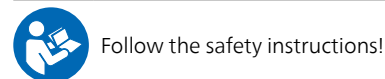
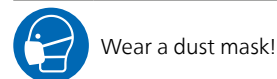
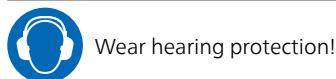
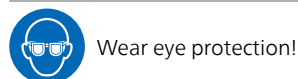

Matching product diameter

Select the POLISTAR diameter based on the respective pipe's inner diameter: Dia. 2" for inner pipe dia. 1-3/8"–1-5/8", Dia. 2-1/4" for inner pipe dia. 1-5/8"–1-3/4", Dia. 2-3/4" for inner pipe dia. 1-3/4"–2", Dia. 3-1/8" for inner pipe dia. 2"–2-1/4", Dia. 3-1/2" for inner pipe dia. 2-1/4"–2-3/8", Dia. 4" for inner pipe dia. 2-3/8"–2-5/8"

Suitable grit size

Select the appropriate grit size for the desired roughness value:

- Grit size 60 = 39–51 μm (1.0–1.3 μm) R_a
- Grit size 120 = 24–39 μm (0.6–1.0 μm) R_a
- Grit size 180 = 16–24 μm (0.4–0.6 μm) R_a
- Grit size 240 = 12–16 μm (0.3–0.4 μm) R_a
- Grit size 320 = 0.2–0.3 μm (0.2–0.3 μm) R_a

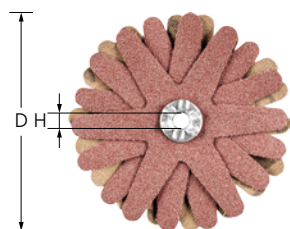

POLISTAR-TUBE

POLISTAR-TUBE consists of multi-layered coated abrasive stars riveted together. They are designed specifically for working on the inner surfaces of pipes and pipe bends. Can be stacked in several layers. Align at an offset from one another so that the abrasive has the best effect.

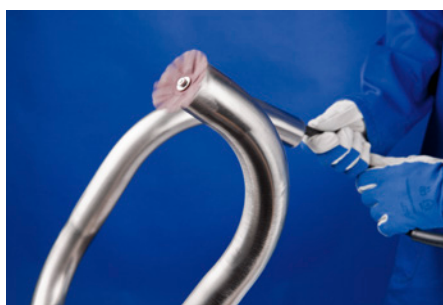

Special features:

- Conforms to contours due to high flexibility.
- The product dimensions ensure optimal processing of small internal diameters, in particular diameters of 1-3/8" – 2-5/8".

D [Inch]	Abrasive	Grit size	Number of layers	Opt. RPM	Max. RPM	Suitable arbors		Item no.	EDP no.
2	A	60	6	3,000	7,650	42400010	10	42732063	44015
		120	6	3,000	7,650	42400010	10	42732066	44016
		180	6	3,000	7,650	42400010	10	42732068	44017
		240	6	3,000	7,650	42400010	10	42732069	44018
		320	6	3,000	7,650	42400010	10	42732070	44019
2-1/4	A	60	6	2,500	6,350	42400010	10	42732083	44020
		120	6	2,500	6,350	42400010	10	42732086	44021
		180	6	2,500	6,350	42400010	10	42732088	44022
		240	6	2,500	6,350	42400010	10	42732089	44023
		320	6	2,500	6,350	42400010	10	42732090	44024
2-3/4	A	60	6	2,200	5,450	42400010	10	42732103	44025
		120	6	2,200	5,450	42400010	10	42732106	44026
		180	6	2,200	5,450	42400010	10	42732108	44027
		240	6	2,200	5,450	42400010	10	42732109	44028
		320	6	2,200	5,450	42400010	10	42732110	44029
3-1/8	A	60	6	1,900	4,750	42400010	10	42732123	44030

Continued on next page

D [Inch]	Abrasive	Grit size	Number of layers	Opt. RPM	Max. RPM	Suitable arbors		Item no.	EDP no.
3-1/8	A	120	6	1,900	4,750	42400010	10	42732126	44031
		180	6	1,900	4,750	42400010	10	42732128	44032
		240	6	1,900	4,750	42400010	10	42732129	44033
3-1/2	A	60	8	1,700	4,250	42400011	10	42732143	44035
		120	8	1,700	4,250	42400011	10	42732146	44036
		180	8	1,700	4,250	42400011	10	42732148	44037
		240	8	1,700	4,250	42400011	10	42732149	44038
		320	8	1,700	4,250	42400011	10	42732150	44039
4	A	60	8	1,500	3,820	42400011	10	42732163	44040
		120	8	1,500	3,820	42400011	10	42732166	44041
		180	8	1,500	3,820	42400011	10	42732168	44042
		240	8	1,500	3,820	42400011	10	42732169	44043

4

Arbor for POLISTAR and POLISTAR-TUBE

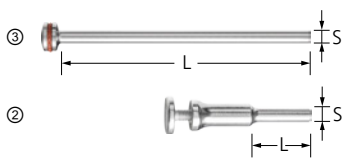

Arbor

Matching arbor for POLISTAR and POLISTAR-TUBE.

Special features:

- Reduced down time due to quick changes.

Suitable for hole diameter [Inch]	S [Inch]	L [Inch]	Clamping width [Inch]		Item no.	EDP no.
4	1/4	1	0 – 3/8	1	42400010	44062
5	1/4	1	0 – 3/8	1	42400011	44063

Non-woven abrasives

Non-woven abrasives consist of

- ① Abrasive grain,
- ② Polyamide fibres and
- ③ Synthetic resins.

The non-woven fibre structure is impregnated/interspersed with resin and abrasive grain. The even distribution of the abrasive grain within the non-woven mixture guarantees a continuous supply of fresh, sharp abrasive grain during the entire grinding operation.

The very loose connections between the individual fibres ensures a high level of flexibility and gives a strong spring-type effect to the non-woven material. It is flexible and supple, and leaves behind a very distinctive surface structure. The satin-finished grinding result is unique and cannot be achieved with other abrasives.

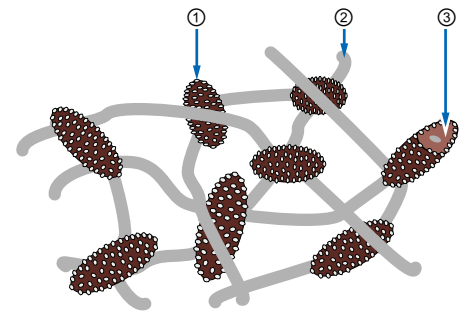

Grit sizes

Non-woven abrasives are labelled according to the following scheme:

PFERD	Grit size [mesh]
very coarse	50–80
coarse	80–100
medium	100–180
fine	180–220
very fine	220–401

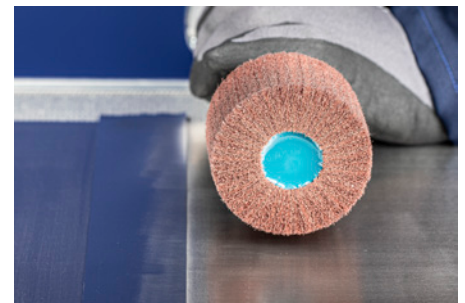

Abrasive

Even though non-woven abrasive has a completely different structure to coated abrasives, the same abrasive materials are used for both tool groups.

Aluminum oxide

Aluminum oxide is very durable, achieves a top service life and is very aggressive on hardened steel. The surface generated is characterized by a higher level of shine. When used on aluminum, discoloration is prevented.

Silicon carbide (SiC)

Silicon carbide (SiC) is even sharper, harder and has better cutting characteristics. It quickly produces a finer, long-lasting slightly matte grinding pattern on the surfaces of many materials.

Safety notes

- For safety reasons, the maximum permitted rotational speed indicated must never be exceeded.
- For best performance, use at a recommended peripheral speed of 3,000–6,900 SFPM.
- For best performance, use with a recommended peripheral speed of 4,000 SFPM. This provides an ideal compromise between stock removal rate, surface quality, thermal load on the workpiece and convolute wheel wear.
- For best performance, use with a recommended peripheral speed of 2,000–4,000 SFPM.
- For best performance, use with a recommended peripheral speed of 3,000–4,000 SFPM.



Wear hearing protection!



Wear gloves!



Wear a dust mask!



Follow the safety instructions!



Wear eye protection!



Non-woven products

General information



Available types and hardness grades

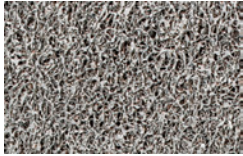

Unitized PNER

Due to different combinations of compaction, fibres, grain and the appropriate bond, this product can be used for a wide range of surface finishing applications, from relatively coarse grinding to preparing the surface for polishing.



Convolute PNK

The non-woven abrasive is wound around a core and foamed up. The products can be optimized for a variety of applications by implementing different foam, fibre, grain and bond combinations. The spectrum of application ranges from fine deburring through to preparations for polishing.

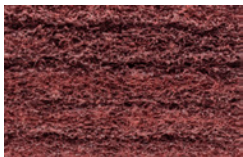

Radial construction PNL

Made of radially arranged flaps of non-woven abrasive material. The flaps are very tightly packed, which achieves a longer service life. The flap wheel's main application is surface work.

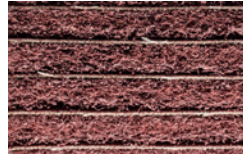

Interleaved construction PNZ

The non-woven abrasive is arranged in multiple radial flaps, with one abrasive cloth interlayer between each set of flaps. This flap combination facilitates greater stock removal and a coarser surface finish.



Corrugated construction PNG

The non-woven abrasive comprises several very wavy strips of non-woven material wound around a core.

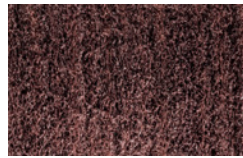

Axial layered construction PNR

The non-woven abrasive material is arranged in multiple (axial) disc layers. Since the individual non-woven discs are not interconnected, the abrasive surface adapts easily to different workpiece contours, e.g. when working on profiles or pipes.

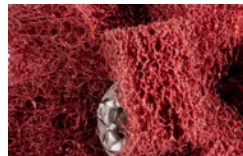

Cross buffs PNST

The non-woven abrasive is star-shaped and stacked in layers which are connected in the center. It offers outstanding performance, specifically when used for tight work areas such as holes, recesses and hard-to-reach places.



Available types

- W

Soft variant with outstanding adaptability. At the same time, durability, abrasive performance and very high surface quality are all maintained. Ideally suited to machining contours.
- MW

Medium-soft variant with increased edge strength and extended service life, for tough blending and polishing applications. Well suited to machining contours.

- MH

Medium-hard variant with increased edge strength and extended service life, for tough deburring and cleaning applications.
- H

Hard variant with very high stock removal rate, good edge strength and long service life, for tough deburring and polishing applications.



Comparison table

PFERD Unitized wheels				3M	Standard Abrasives	Norton	BIBIELLE
Type	Color code	Abrasive	Grit				
Soft	W	SiC	fine	EXL 2S fine	532	UW1-2SF or Nex-2SF	BUH 2SF
		A	coarse	EXL 2A medium	521	UW1-2AM or Nex-2AM	BUH 2AM
Medium-soft	MW	SiC	fine	EXL 4S fine or SST 3S fine	632	UW1-4SF	BUH 3SF
		A	fine	EXL 4A fine or SST 3A fine	631	UW1-4AF	-
Medium-hard	MH	A	fine	Cut & polish 5A fine or SST 5A fine	731	UW1-6AF or Nex-6AF	-
Hard	H	A	fine	Cut & polish 7A medium or 9A medium	821	UW1-8AM or Nex-8AM	BUH 6AM
		A	coarse	Cut & polish 7A coarse or 9A coarse	811	UW1-8AC or Nex-8AC	BUH 8AC



Non-woven products

POLINOX® unitized wheels

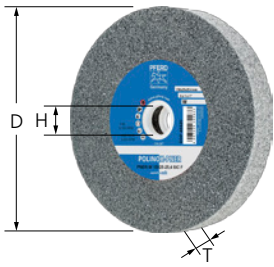

POLINOX® unitized wheels

POLINOX® unitized wheels and discs consist of multiple heavily compressed, non-woven layers, which are bonded together by a special grain/resin system. This particular bond results in non-woven products with a very good surface finish, high stock removal rate and long service life. These properties are particularly apparent when deburring, blending, finishing and polishing soft metals, alloyed and high-alloy steels, in addition to titanium alloys.



Special features:

- Cost-effective due to high abrasive performance and durability.
- These properties are particularly apparent when deburring, blending, finishing and polishing soft metals, alloyed and high-alloy steels, in addition to titanium alloys.

4

D [Inch]	T [Inch]	H [Inch]	Specification	Grit size	Version	Abrasive	Opt. RPM	Max. RPM	Suitable arbors		Item no.	EDP no.
Compatible power tools: Flexible shaft drives; Straight grinders; Bench grinders												
2	1/8	1/4	8AM	fine	H	A	9,500	15,300	33700132	10	44691005	48268
			6AC	coarse	MH	A	9,500	15,300	33700132	10	47700208	48240
3	1/8	1/4	2AM	coarse	W	A	6,400	10,200	33700132	10	47803085	48247
			2SF	fine	W	SiC	6,400	10,200	33700132	10	47803086	48245
			3SF	fine	MW	SiC	6,400	10,200	33700132	10	47803087	48246
			6AF	fine	MH	A	6,400	10,200	33700132	10	47803088	48248
			6AC	coarse	MH	A	6,400	10,200	33700132	10	47700209	48241
			8AC	coarse	H	A	6,400	10,200	33700132	10	47803089	48249
			8AM	fine	H	A	6,400	10,200	33700132	10	44691010	48288
			2AM	coarse	W	A	6,400	10,200	33700132	5	44691621	48291
	1/4	1/4	2SF	fine	W	SiC	6,400	10,200	33700132	5	44691627	48290
			3AF	fine	MW	A	6,400	10,200	33700132	5	44691422	48293
			3SF	fine	MW	SiC	6,400	10,200	33700132	5	44691427	48292
			6AF	fine	MH	A	6,400	10,200	33700132	5	44691222	48295
			8AC	coarse	H	A	6,400	10,200	33700132	5	44691021	48299
			2AM	coarse	W	A	6,400	10,200	33700132	5	44691641	48311
1/2	1/4	2SF	fine	W	SiC	6,400	10,200	33700132	5	44691647	48310	
		3AF	fine	MW	A	6,400	10,200	33700132	5	44691442	48313	
		3SF	fine	MW	SiC	6,400	10,200	33700132	5	44691447	48312	
		6AF	fine	MH	A	6,400	10,200	33700132	5	44691242	48315	
		8AC	coarse	H	A	6,400	10,200	33700132	5	44691041	48319	
		2AM	coarse	W	A	6,400	10,200	33700132	5	44691641	48311	
6	1	1	2SF	fine	W	SiC	3,200	5,100	47601151	1	44691667	48420
			3AF	fine	MW	A	3,200	5,100	47601151	1	44691462	48423
			3SF	fine	MW	SiC	3,200	5,100	47601151	1	44691467	48422
			6AF	fine	MH	A	3,200	5,100	47601151	1	44691262	48425
			8AC	coarse	H	A	3,200	5,100	47601151	1	44691061	48429



POLINOX® unitized wheels

Consist of multiple heavily compressed, non-woven layers, which are bonded together by a special grain/resin system. Particularly suitable for work on fillet welds and hard-to-reach slots or indentations.

Special features:

- Cost-effective due to high abrasive performance and durability.
- Produces very good surface quality. Can be profiled as desired, enabling optimal adjustment to the contour.
- Ideal for cleaning, deburring, blending and polishing.

D [Inch]	T [Inch]	H [Inch]	Grit size	Version	Abrasive	Opt. RPM	Max. RPM		Item no.	EDP no.	
Compatible power tools: angle grinders and fillet weld grinders											
5	1/4	7/8	fine	MW (medium-soft)	A	4,500	6,100	5	44691453	48353	
					SiC	4,500	6,100	5	44691452	48352	
			coarse	MH (medium-hard)	A	4,500	6,100	5	44691252	48355	
					MH (medium-hard)	A	4,500	6,100	5	47700211	48243
					H (hard)	A	4,500	6,100	5	44691053	48359
	fine	H (hard)	A	4,500	6,100	5	44691052	48358			
6	1/8	1	fine	MW (medium-soft)	SiC	3,800	5,100	5	44691628	48360	
					MH (medium-hard)	SiC	3,800	5,100	5	44691629	48361
			coarse	MH (medium-hard)	A	3,800	5,100	5	47700210	48242	
					H (hard)	A	3,800	5,100	5	44691630	48362
	1/4	1	fine	W (soft)	SiC	3,800	5,100	5	44691631	48363	
					MW (medium-soft)	SiC	3,800	5,100	5	44691632	48364
			coarse	MH (medium-hard)	A	3,800	5,100	5	47700212	48244	
	1/2	1/2	1/2	fine	W (soft)	SiC	3,800	5,100	1	47802723	48510
						MW (medium-soft)	SiC	3,800	5,100	1	47700200
					MH (medium-hard)	SiC	3,800	5,100	1	47700201	48512



Non-woven products

POLINOX® unitized discs



POLINOX® unitized discs for speed-adjustable angle grinders

POLINOX® unitized wheels and discs consist of multiple heavily compressed, non-woven layers, which are bonded together by a special grain/resin system. This particular bond results in non-woven products with a very good surface finish, high stock removal rate and long service life. These properties are particularly apparent when deburring, blending, finishing and polishing soft metals, alloyed and high-alloy steels, in addition to titanium alloys.



Special features:

- Cost-effective due to high abrasive performance and durability.
- Produces very good surface quality. Can be profiled as desired, enabling optimal adjustment to the contour.
- Ideal for cleaning, deburring, blending and polishing.

D [Inch]	T [Inch]	H [Inch]	Grit size	Version	Abrasive	Opt. RPM	Max. RPM		Item no.	EDP no.
4-1/2	1/2	7/8	fine	W (soft)	SiC	6,000	10,000	5	44690732	48470
				MW (medium-soft)	SiC	6,000	10,000	5	44690722	48472
				MH (medium-hard)	SiC	6,000	10,000	5	44690712	48474
5	1/2	7/8	fine	W (soft)	SiC	5,400	10,000	5	44690733	48480
				MW (medium-soft)	SiC	5,400	10,000	5	44690723	48482
				MH (medium-hard)	SiC	5,400	10,000	5	44690713	48484
Threaded arbor hole										
4-1/2	1/2	5/8-11	fine	W (soft)	SiC	6,000	10,000	5	47802693	48490
				MW (medium-soft)	SiC	6,000	10,000	5	47802694	48492
				MH (medium-hard)	SiC	6,000	10,000	5	47802695	48494
5	1/2	5/8-11	fine	W (soft)	SiC	5,400	10,000	5	47802696	48500
				MW (medium-soft)	SiC	5,400	10,000	5	47802697	48502
				MH (medium-hard)	SiC	5,400	10,000	5	47802698	48504

Available types

- W

Soft

Soft version with outstanding abrasive performance on contours. Ideal for blending surfaces.
- MW

Medium-soft

Medium-soft version with increased flexibility and tool life for coarse blending applications and for light deburring and polishing work. Well-suited to work on contours.
- MH

Medium-hard

Medium-hard version with increased edge strength and service life for coarse deburring applications and deburring, blending and cleaning work.

- H

Hard

Hard version with very high stock removal rate, good edge strength and long service life for medium to heavy-duty deburring and polishing applications.
- EH

Extra-hard

Extra-hard version with excellent edge strength for demanding deburring work.



Comparison table

Type	PFERD Convolute wheels			3M	Standard Abrasives	Norton	BIBIELLE
	Color code	Abrasive	Grit				
Soft	W	A	coarse	CP-WL 5AM	MF CV 5AM	MF CF 5AM	BCW-MF 5AM
Medium-soft	MW	SiC	fine	LDW 7SF	LDW 7SF	Series 2000 7SF	BCW-DB 7SF
Medium-hard	MH	SiC	fine	EXL Deburring 8SF	Deburring 8SF	Series 1000 8SF	BCW-DB 8SF
	MH	A	coarse	EXL Deburring 8AM	GP Plus 8AM	Series 1000 8AM	BCW-DB 8AM
Hard	H	SiC	fine	Deburring 9SF	EXL Deburring 9SF	Series 1000 9SF	BCW-DB 9SF
Extra-hard	EH	SiC	fine	XP-WL 10SF	GP Plus 10SF	Series 4000 9SF	BCW-DB 9SF-R



Non-woven products

POLINOX® convolute wheels



POLINOX® convolute wheels

Consist of spiral-shaped, non-woven abrasive which is wound around a core. Designed for working on soft metals, alloyed and high-alloy steels and titanium alloys, e.g. on turbine blades and for the removal of processing traces on surgical instruments.



Special features:

- Cost-effective due to high abrasive performance and durability.
- Produces very good surface quality. Can be profiled as desired, enabling optimal adjustment to the contour.
- Ideal for cleaning, deburring, blending and polishing.

4

D [Inch]	T [Inch]	H [Inch]	Specification	Grit size	Version	Abrasive	Opt. RPM	Max. RPM		Item no.	EDP no.
6	1/2	1	7SF	fine	MW (medium-soft)	SiC	2,500	5,100	1	47802637	48200
			8SF	fine	MH (medium-hard)	SiC	2,500	5,100	1	47802639	48202
			8AM	coarse	MH (medium-hard)	A	2,500	5,100	1	47802638	48201
			9SF	fine	H (hard)	SiC	2,500	5,100	1	47802640	48203
			10SF	fine	EH (extra-hard)	SiC	2,500	5,100	1	47803030	48222
	1	1	5AM	coarse	W (soft)	A	2,500	5,100	1	47802730	48199
			7SF	fine	MW (medium-soft)	SiC	2,500	5,100	1	47802641	48204
			8SF	fine	MH (medium-hard)	SiC	2,500	5,100	1	47802643	48206
			8AM	coarse	MH (medium-hard)	A	2,500	5,100	1	47802642	48205
			9SF	fine	H (hard)	SiC	2,500	5,100	1	47802644	48207
8	1/2	3	7SF	fine	MW (medium-soft)	SiC	1,900	3,850	1	47802645	48208
			8SF	fine	MH (medium-hard)	SiC	1,900	3,850	1	47802647	48210
			8AM	coarse	MH (medium-hard)	A	1,900	3,850	1	47802646	48209
			9SF	fine	H (hard)	SiC	1,900	3,850	1	47802648	48211
			10SF	fine	EH (extra-hard)	SiC	1,900	3,850	1	47802882	48224
	1	3	5AM	coarse	W (soft)	A	1,900	3,850	1	47803029	48220
			7SF	fine	MW (medium-soft)	SiC	1,900	3,850	1	47802649	48212
			8SF	fine	MH (medium-hard)	SiC	1,900	3,850	1	47802651	48214
			8AM	coarse	MH (medium-hard)	A	1,900	3,850	1	47802650	48213
			9SF	fine	H (hard)	SiC	1,900	3,850	1	47802652	48215
	2	3	10SF	fine	EH (extra-hard)	SiC	1,900	3,850	1	47802881	48225
			5AM	coarse	W (soft)	A	1,900	3,850	1	47802732	48221
			7SF	fine	MW (medium-soft)	SiC	1,900	3,850	1	47802653	48216
			8SF	fine	MH (medium-hard)	SiC	1,900	3,850	1	47802655	48218
			8AM	coarse	MH (medium-hard)	A	1,900	3,850	1	47802654	48217
			9SF	fine	H (hard)	SiC	1,900	3,850	1	47802656	48219
			10SF	fine	EH (extra-hard)	SiC	1,900	3,850	1	47802880	48226

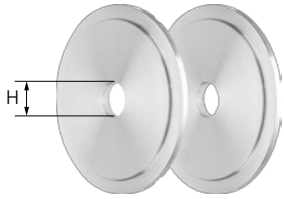

Reducing flanges for POLINOX® convolute wheels

For mounting POLINOX® convolute wheels with an 8" diameter on stationary machines such as double grinding machines (bench grinders).

Special features:

- Highly accurate fit.
- Hole can be drilled out and resized as desired.

Suitable for tool diameter [Inch]	H [Inch]		Item no.	EDP no.
3	5/8	1	47601200	45690
	1	1	47601201	45692
	1-1/4	1	47601202	45693

POLINOX® mounted flap wheels

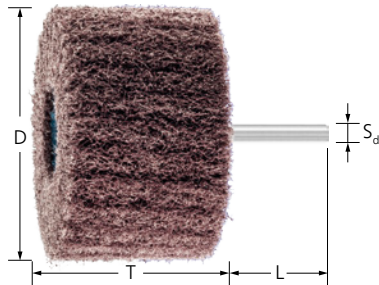

Radial construction

Made of radially arranged flaps of non-woven abrasive material. A long service life is achieved through the dense packing of the flaps.



Special features:

- Conforms to contours due to high flexibility.
- Cool grinding and low thermal load on the workpiece.
- No loading due to open structure and high flexibility of the non-woven material.

D [Inch]	T [Inch]	S _d [Inch]	L [Inch]	Abrasive	Grit size	Opt. RPM	Max. RPM		Item no.	EDP no.
Aluminum oxide A										
1	1	1/4	1-1/2	A	100	10,000	20,000	10	47803111	46198
					180	10,000	20,000	10	47803112	46199
					280	10,000	20,000	10	47803113	46200
1-1/2	3/4	1/4	1-1/2	A	80	7,500	15,000	10	47803371	46188
					100	7,500	15,000	10	47801032	46201
					180	7,500	15,000	10	47801033	46202
					280	7,500	15,000	10	47801034	46203
					360	7,500	15,000	10	47803372	46189
2	1	1/4	1-1/2	A	80	6,000	12,000	10	47803373	46190
					100	6,000	12,000	10	47801121	46204
					180	6,000	12,000	10	47801053	46205
					280	6,000	12,000	10	47801078	46206
					360	6,000	12,000	10	47803374	46191
2-3/8	2	1/4	1-1/2	A	80	5,000	10,000	10	47803375	46192
					100	5,000	10,000	10	47801694	46207
					180	5,000	10,000	10	47801129	46208
					280	5,000	10,000	10	47801127	46209
					360	5,000	10,000	10	47803376	46193

Continued on next page

Non-woven products

POLINOX® mounted flap wheels



D [Inch]	T [Inch]	S _d [Inch]	L [Inch]	Abrasive	Grit size	Opt. RPM	Max. RPM		Item no.	EDP no.
3	1	1/4	1-1/2	A	100	4,000	7,500	10	47802667	46251
					180	4,000	7,500	10	47802668	46252
					280	4,000	7,500	10	47802669	46253
					80	4,000	7,500	10	47803377	46194
	2	1/4	1-1/2	A	100	4,000	7,500	10	47801054	46210
					180	4,000	7,500	10	47801072	46211
					280	4,000	7,500	10	47801048	46212
	1	1/4	1-1/2	A	360	4,000	7,500	10	47803378	46195



Interleaved construction

The non-woven abrasive material is arranged in multiple radial flaps, with abrasive cloth interlayers. This flap structure facilitates improved stock removal and achieves a coarser surface finish.

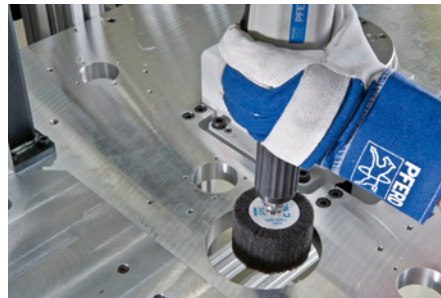

Special features:

- Conforms to contours due to high flexibility.
- Cool grinding and low thermal load on the workpiece.
- The open structure and high flexibility of the non-woven material prevents loading.

D [Inch]	T [Inch]	S _d [Inch]	L [Inch]	Abrasive	Grit size	Opt. RPM	Max. RPM		Item no.	EDP no.
Aluminum oxide A										
1	1	1/4	1-1/2	A	100	10,000	20,000	10	47803114	46196
					180	10,000	20,000	10	47803115	46197
1-1/2	3/4	1/4	1-1/2	A	80	7,500	15,000	10	47803379	46271
					100	7,500	15,000	10	47801035	46219
					180	7,500	15,000	10	47802099	46225
2	1	1/4	1-1/2	A	80	6,000	12,000	10	47803380	46272
					100	6,000	12,000	10	47801075	46220
								180	6,000	12,000
2-3/8	2	1/4	1-1/2	A	80	5,000	10,000	10	47803381	46273
					100	5,000	10,000	10	47801036	46221
					180	5,000	10,000	10	47801802	46227
3	2	1/4	1-1/2	A	80	4,000	7,500	10	47803382	46274
	1	1/4	1-1/2	A	100	4,000	7,500	10	47802670	46269
					180	4,000	7,500	10	47802671	46270
3-5/32	2	1/4	1-1/2	A	100	4,000	7,500	10	47801037	46222
					180	4,000	7,500	10	47801154	46228
4	2	1/4	1-1/2	A	100	3,000	6,000	5	47801150	46223
					180	3,000	6,000	5	47801155	46229

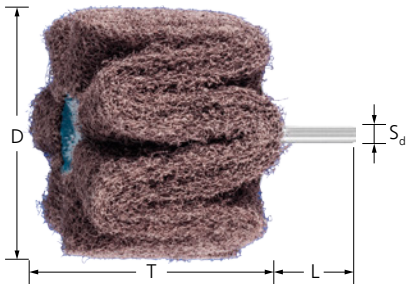

Corrugated construction

The non-woven abrasive comprises several very wavy strips of non-woven material wound around a core. The wavy structure of the non-woven material permits seamless brush matting of surfaces.

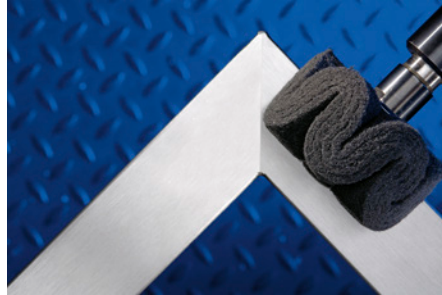

Special features:

- Conforms to contours due to high flexibility.
- Cool grinding and low thermal load on the workpiece.
- The open structure and high flexibility of the non-woven material prevents loading.

D [Inch]	T [Inch]	S _d [Inch]	L [Inch]	Abrasive	Grit size	Opt. RPM	Max. RPM		Item no.	EDP no.
Aluminum oxide A										
3	2	1/4	1-1/2	A	100	4,000	7,500	10	47802481	46236
					180	4,000	7,500	10	47802473	46237
					280	4,000	7,500	10	47802482	46238
4	2	1/4	1-1/2	A	100	3,000	6,000	5	47802478	46232
					180	3,000	6,000	5	47802479	46230
					280	3,000	6,000	5	47802480	46231
Silicon carbide (SiC)										
3	2	1/4	1-1/2	SiC	100	4,000	7,500	10	47802485	46239
					180	4,000	7,500	10	47802486	46240
					280	4,000	7,500	10	47802672	46241
4	2	1/4	1-1/2	SiC	100	3,000	6,000	5	47802484	46233
					180	3,000	6,000	5	47802483	46234
					280	3,000	6,000	5	47802673	46235



Non-woven products

POLINOX® mounted flap wheels

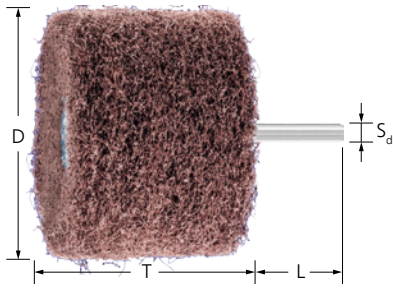

Axial layered construction

The non-woven abrasive is arranged in multiple (axial) disc layers. Since the individual non-woven discs are not interconnected, the abrasive surface adapts easily to different workpiece contours, e.g. when working on profiles or pipes.



Special features:

- Conforms to contours due to high flexibility.
- Cool grinding and low thermal load on the workpiece.
- The open structure and high flexibility of the non-woven material prevents loading.

D [Inch]	T [Inch]	S _d [Inch]	L [Inch]	Abrasive	Grit size	Opt. RPM	Max. RPM		Item no.	EDP no.
Shank diameter 1/4"										
2-3/8	2	1/4	1-1/2	A	100	5,000	10,000	10	47801686	46213
					180	5,000	10,000	10	47801055	46214
					280	5,000	10,000	10	47801074	46215
3	2	1/4	1-1/2	A	100	4,000	7,500	10	47801687	46216
					180	4,000	7,500	10	47801056	46217
					280	4,000	7,500	10	47801753	46218

POLINOX® cross buffs

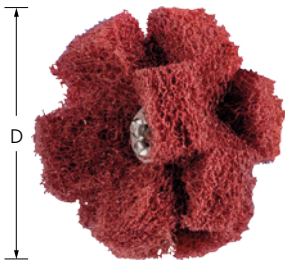

POLINOX® cross buffs

Ideal for cleaning, deburring and fine grinding of inner surfaces and contours. Highly recommended for hard-to-reach places such as drilled holes and indentations.



Special features:

- Optimum adaptation to contours due to high flexibility. Cool grinding and low thermal load of the workpiece.
- The open structure and high flexibility of the non-woven material prevents loading.
- Please order compatible arbor separately.

D [Inch]	Abrasive	Grit size	Number of layers	Opt. RPM	Max. RPM		Item no.	EDP no.
3/4	A	100	2	15,000	25,100	20	44698192	44198
		280	2	15,000	25,100	20	44698193	44199
1	A	80	2	10,000	19,100	20	44698254	44202
		100	2	10,000	19,100	20	44698252	44200
		280	2	10,000	19,100	20	44698253	44201
1-1/2	A	80	3	7,500	12,600	20	44698384	44210
		100	3	7,500	12,600	20	44698382	44208
		280	3	7,500	12,600	20	44698383	44209

Continued on next page

D [Inch]	Abrasive	Grit size	Number of layers	Opt. RPM	Max. RPM		Item no.	EDP no.
2	A	80	2	5,500	9,500	20	44698504	44212
		100	2	5,500	9,500	20	44698502	44213
		280	2	5,500	9,500	20	44698503	44214

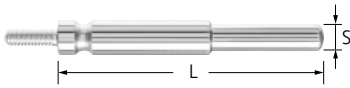

Drive arbor for POLINOX® cross buffs

Arbors for POLINOX® cross buffs.

Special features:

- Reduced down time due to quick changes.

S [Inch]	L [Inch]	Thread	Clamping length [mm]		Item no.	EDP no.
1/4	3	8-32 UNC	1 1/4	1	47601167	44830

POLINOX® unmounted flap wheels

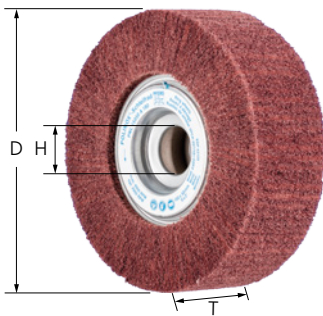

Radial construction

Made of radially arranged flaps of non-woven abrasive material. A long service life is achieved through the dense packing of the flaps. This unmounted flap wheel is ideal for work on large surfaces.



Special features:

- Optimum adaptation to contours due to high flexibility. Cool grinding and low thermal load of the workpiece.
- The open structure and high flexibility of the non-woven material prevents loading.
- Please order compatible arbor separately.

D [Inch]	T [Inch]	H [Inch]	Abrasive	Grit size	Opt. RPM	Max. RPM	Suitable arbors		Item no.	EDP no.
6	2	1	A	100	2,000	4,000	47601151	1	44644111	43128
				180	2,000	4,000	47601151	1	44644119	43129
				280	2,000	4,000	47601151	1	44644129	43130
8	2	1-3/4	A	100	1,500	3,000	47601152	1	44644211	43137
				180	1,500	3,000	47601152	1	44644219	43138
				280	1,500	3,000	47601152	1	44644229	43139



Non-woven products

POLINOX® unmounted flap wheels

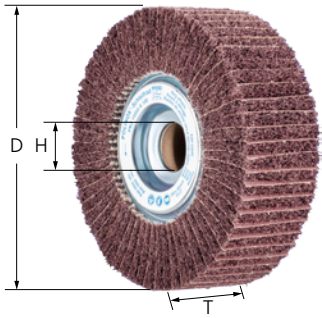

Interleaved construction

The non-woven abrasive material is arranged in multiple radial flaps, with abrasive cloth interlayers. This flap structure facilitates improved stock removal and achieves a coarser surface finish. This unmounted flap wheel is ideal for work on large surfaces.

Special features:

- Optimum adaptation to contours due to high flexibility. Cool grinding and low thermal load of the workpiece.
- The open structure and high flexibility of the non-woven material prevents loading.
- Please order compatible arbor separately.

D [Inch]	T [Inch]	H [Inch]	Abrasive	Grit size	Opt. RPM	Max. RPM	Suitable arbors		Item no.	EDP no.
6	2	1	A	100	2,000	4,000	47601151	1	44645111	43045
				180	2,000	4,000	47601151	1	44645119	43046
8	2	1-3/4	A	100	1,500	3,000	47601152	1	44645211	43048
				180	1,500	3,000	47601152	1	44645219	43049

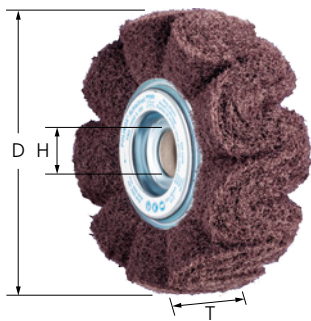

Corrugated construction

Made of several wavy arranged strips of non-woven abrasive material, wound around a core. The wavy structure of the non-woven abrasive material permits seamless matte finishing of surfaces.

Special features:

- Optimum adaptation to contours due to high flexibility. Cool grinding and low thermal load of the workpiece.
- The open structure and high flexibility of the non-woven material prevents loading.
- Please order compatible arbor separately.

D [Inch]	T [Inch]	H [Inch]	Abrasive	Grit size	Opt. RPM	Max. RPM	Suitable arbors		Item no.	EDP no.
6	2	1	A	100	2,000	4,000	47601151	1	44646111	43030
				180	2,000	4,000	47601151	1	44646119	43031
				280	2,000	4,000	47601151	1	44646129	43032
8	2	1-3/4	A	100	1,500	3,000	47601152	1	44646211	43036
				180	1,500	3,000	47601152	1	44646219	43037
				280	1,500	3,000	47601152	1	44646229	43038

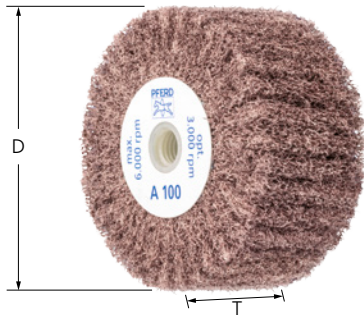

Radial construction

Made of radially arranged flaps of non-woven abrasive material. The flaps are very tightly packed, which achieves a longer service life. The flap wheel's main application is surface work.

Special features:

- Optimum adaptation to contours due to high flexibility. Cool grinding and low thermal load of the workpiece.
- The open structure and high flexibility of the non-woven material prevents loading.
- Can be mounted directly onto the drive system's spindle without the need for additional clamping devices.

D [Inch]	T [Inch]	Thread	Abrasive	Grit size	Opt. RPM	Max. RPM		Item no.	EDP no.
4	2	5/8-11	A	100	3,000	6,000	5	44642021	43188
				180	3,000	6,000	5	44642022	43189
				280	3,000	6,000	5	44642023	43190

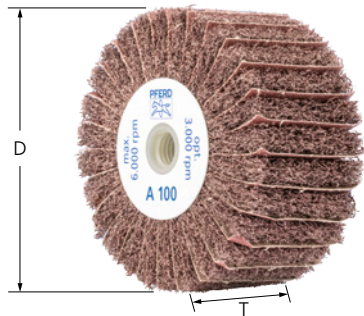

Interleaved construction

The non-woven abrasive is arranged in multiple radial flaps, with one abrasive cloth interlayer between each set of flaps. This flap combination facilitates greater stock removal and a coarser surface finish.



Special features:

- Optimum adaptation to contours due to high flexibility. Cool grinding and low thermal load of the workpiece.
- The open structure and high flexibility of the non-woven material prevents loading.
- Can be mounted directly onto the drive system's spindle without the need for additional clamping devices.

D [Inch]	T [Inch]	Thread	Abrasive	Grit size	Opt. RPM	Max. RPM		Item no.	EDP no.
4	2	5/8-11	A	100	3,000	6,000	5	44642121	43013
				180	3,000	6,000	5	44642122	43014



Non-woven products

POLINOX® unmounted flap wheels, threaded

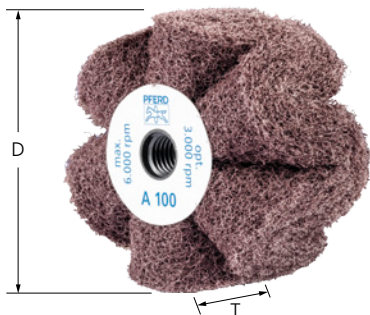

Corrugated construction

The non-woven abrasive comprises several very wavy strips of non-woven material wound around a core. The wavy structure of the non-woven material permits seamless brush matting of surfaces.



Special features:

- Optimum adaptation to contours due to high flexibility. Cool grinding and low thermal load of the workpiece.
- The open structure and high flexibility of the non-woven material prevents loading.
- Can be mounted directly onto the drive system's spindle without the need for additional clamping devices.

D [Inch]	T [Inch]	Thread	Abrasive	Grit size	Opt. RPM	Max. RPM		Item no.	EDP no.
4	2	5/8-11	A	100	3,000	6,000	5	44642221	43024
				180	3,000	6,000	5	44642222	43025
				280	3,000	6,000	5	44642223	43026
5	2	5/8-11	A	100	2,300	3,800	1	44642521	43107
				180	2,300	3,800	1	44642522	43108
				280	2,300	3,800	1	44642523	43109

POLINOX® grinding discs



Radial construction

Non-woven abrasive flaps with a fibreglass backer, for face-down finishing work. Densely-stacked flaps for long service life. The disc is designed for working on large surfaces with variable-speed angle grinders.

Special features:

- Optimum adaptation to contours due to high flexibility. Cool grinding and low thermal load of the workpiece.
- The open structure and high flexibility of the non-woven material prevents loading.
- The disc is designed for working on large surfaces with variable-speed angle grinders.

D [Inch]	T [Inch]	H [Inch]	Abrasive	Grit size	Opt. RPM	Max. RPM		Item no.	EDP no.
4-1/2	3/4	7/8	A	100	2,500	5,300	5	44692258	45891
				180	2,500	5,300	5	44692259	45892
				280	2,500	5,300	5	44692260	45893
5	3/4	7/8	A	100	2,300	3,800	5	44692261	45894
				180	2,300	3,800	5	44692262	45895
				280	2,300	3,800	5	44692263	45896



Interleaved construction

Interleaved abrasive and non-woven flaps with a fibreglass backer for face-down finishing work. Densely-stacked flaps for long service life and increased stock removal. The disc is designed for working on large surfaces with variable-speed angle grinders.

Special features:

- Optimum adaptation to contours due to high flexibility. Cool grinding and low thermal load of the workpiece.
- The open structure and high flexibility of the non-woven material prevents loading.
- The disc is designed for working on large surfaces with variable-speed angle grinders.

D [Inch]	T [Inch]	H [Inch]	Abrasive	Grit size	Opt. RPM	Max. RPM		Item no.	EDP no.
4-1/2	3/4	7/8	A	100	2,500	5,300	5	44692264	45911
				180	2,500	5,300	5	44692265	45912
5	3/4	7/8	A	100	2,300	3,800	5	44692266	45915
				180	2,300	3,800	5	44692267	45916

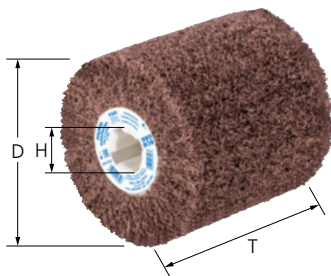

Radial construction

For work on large surfaces. The non-woven abrasive material with aluminum oxide A as the abrasive is arranged in multiple radial flaps. A long service life is achieved through the dense packing of the flaps.



Special features:

- Long service life due to tightly packed flaps. Cool grinding and low thermal load on the workpiece.
- The open structure and high flexibility of the non-woven material prevents loading.
- The 3/4" center hole diameter with 4 key-ways fits all conventional drum grinders.

D [Inch]	T [Inch]	H [Inch]	Abrasive	Grit size	Opt. RPM	Max. RPM		Item no.	EDP no.
4	4	3/4	A	80	2,500	4,800	1	47801097	43102
				100	2,500	4,800	1	44641010	43103
				180	2,500	4,800	1	44641018	43104
				280	2,500	4,800	1	44641028	43105
5	4	5/8-11	A	100	2,300	3,100	1	47802797	46786
				180	2,300	3,100	1	47802798	46787
				280	2,300	3,100	1	47802799	46788



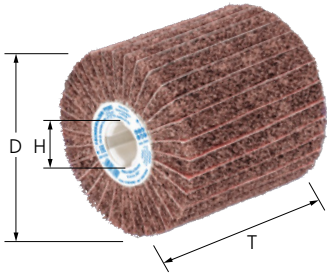

Interleaved construction

Made of radially arranged flaps of non-woven abrasive material. There is also abrasive cloth situated between the flaps. The flap structure facilitates improved stock removal and achieves a coarser surface finish.



Special features:

- Long service life due to tightly packed flaps. Cool grinding and low thermal load on the workpiece.
- The open structure and high flexibility of the non-woven material prevents loading.
- The 3/4" center hole diameter with 4 key-ways fits all conventional drum grinders.

D [Inch]	T [Inch]	H [Inch]	Abrasive	Grit size	Opt. RPM	Max. RPM		Item no.	EDP no.
4	4	3/4	A	60	2,500	4,800	1	44641106	43113
				80	2,500	4,800	1	44641108	43114
				120	2,500	4,800	1	44641112	43115
5	4	5/8-11	A	60	2,300	3,100	1	47802794	46789
				80	2,300	3,100	1	47802795	46790
				120	2,300	3,100	1	47802796	46791

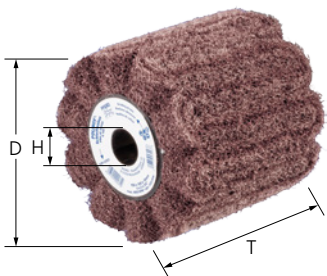

Corrugated construction

The non-woven abrasive comprises several very wavy strips of non-woven material wound around a core. The wavy structure of the non-woven material permits seamless brush matting of surfaces.



Special features:

- Long tool life thanks to tight, wavy flaps. Cool grinding and low thermal load on the workpiece.
- The open structure and high flexibility of the non-woven material prevents loading.
- The 3/4" center hole diameter with 4 key-ways fits all conventional drum grinders.

D [Inch]	T [Inch]	H [Inch]	Abrasive	Grit size	Opt. RPM	Max. RPM		Item no.	EDP no.
4	4	3/4	A	100	2,500	4,800	1	44641201	43003
				180	2,500	4,800	1	44641202	43004
				280	2,500	4,800	1	44641203	43005



High-strength masking tape

The self-adhesive masking tape is used during finish machining with soft, flexible products such as non-woven products. Different grinding patterns in adjacent areas can be clearly separated.

Special features:

- The masking tape protects surfaces which have already been worked on, or are not supposed to be worked on.
- High elasticity and tear strength.
- High edge stability. Use only during finish machining with soft, flexible products, e.g. non-woven products.

L Feet	T [Inch]		Item no.	EDP no.
82	3/4	1	44250130	43000



High-strength masking tape

The self-adhesive masking tape is used to preserve the clear separation between different grinding patterns in adjacent stainless steel areas.



Special features:

- The masking tape protects surfaces which have already been worked on, or are not supposed to be worked on.
- 2" width: Reusable and extremely high durability.
- 3/4" width: High elasticity and tear strength.

L Feet	T [Inch]		Item no.	EDP no.
10	2	1	44250140	43001



Non-woven products

POLIVLIES® flap discs



Aluminum oxide A

Flap discs with abrasive flaps made of aluminum oxide A for universal coarse to fine grinding applications in industry and professional trades.

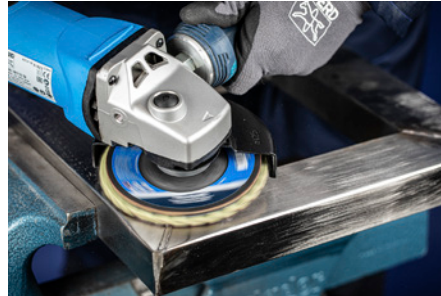

Special features:

- Cost-effective due to high abrasive performance and durability.
- Creates a consistently high surface quality throughout the entire service life, as new sharp abrasive material is constantly exposed.
- Conforms to contours due to high flexibility.

D [Inch]	T [Inch]	H [Inch]	Abrasive	Grit size	Opt. RPM	Max. RPM		Item no.	EDP no.
Plain arbor hole									
4-1/2	3/4	7/8	A	100 G	5,000 – 5,800	13,300	5	44694101	43273
				180 M	5,000 – 5,800	13,300	5	44694102	43274
				240 F	5,000 – 5,800	13,300	5	44694103	43275
5	3/4	7/8	A	100 G	4,600 – 5,300	12,200	5	44694111	43276
				180 M	4,600 – 5,300	12,200	5	44694112	43277
				240 F	4,600 – 5,300	12,200	5	44694113	43278
Threaded arbor hole									
4-1/2	3/4	5/8-11	A	100 G	5,000 – 5,800	13,300	5	47202059	43285
				180 M	5,000 – 5,800	13,300	5	47202060	43286
				240 F	5,000 – 5,800	13,300	5	47202061	43287
5	3/4	5/8-11	A	100 G	4,600 – 5,300	12,200	5	47202062	43288
				180 M	4,600 – 5,300	12,200	5	47202063	43289
				240 F	4,600 – 5,300	12,200	5	47202064	43290
X-LOCK mounting									
4-1/2	3/4	7/8	A	100 G	5,000 – 5,800	13,300	5	44694201	43303
				180 M	5,000 – 5,800	13,300	5	44694202	43304
				240 F	5,000 – 5,800	13,300	5	44694203	43305
5	3/4	7/8	A	100 G	4,600 – 5,300	12,200	5	44694211	43306
				180 M	4,600 – 5,300	12,200	5	44694212	43307
				240 F	4,600 – 5,300	12,200	5	44694213	43308

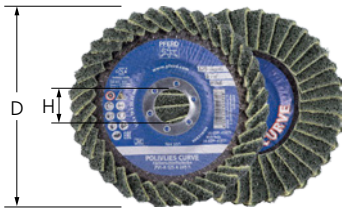

CURVE PVL-R

Flap discs with abrasive flaps made of aluminum oxide A for general coarse to fine grinding applications in industry and professional trades. The CURVE version can be used on both the grinding side and on the rear side, as well as on the radius.

Special features:

- Creates a consistently high surface quality throughout the entire service life, as new sharp abrasive material is constantly exposed.
- Conforms to contours due to high flexibility.
- Cost-effective due to high abrasive performance and durability.

D [Inch]	H [Inch]	Abrasive	Grit size	Opt. RPM	Max. RPM		Item no.	EDP no.
4-1/2	7/8	A	100	5,800	13,300	5	44694121	45920
			180	5,800	13,300	5	44694122	45921
			240	5,800	13,300	5	44694123	45922
5	7/8	A	100	5,300	12,200	5	44694131	45923
			180	5,300	12,200	5	44694132	45924
			240	5,300	12,200	5	44694133	45925

Threaded arbor hole

4-1/2	5/8-11	A	100	5,800	13,300	5	47202190	45926
			180	5,800	13,300	5	47202191	45927
			240	5,800	13,300	5	47202192	45928
5	5/8-11	A	100	5,300	12,200	5	47202193	45929
			180	5,300	12,200	5	47202194	45930
			240	5,300	12,200	5	47202195	45931



Ceramic oxide CO-COOL

Flap discs with abrasive flaps made of ceramic oxide grain CO-COOL and aluminum oxide A. Consistently high performance and aggressive grinding due to self-sharpening ceramic oxide grain. Active grinding additives improve the stock removal rate, prevent clogging and result in cooler grinding.



Special features:

- Cost-effective due to high abrasive performance and durability.
- Creates a consistently high surface quality throughout the entire service life, as new sharp abrasive material is constantly exposed.
- Conforms to contours due to high flexibility.

D [Inch]	T [Inch]	H [Inch]	Abrasive/grit size	Opt. RPM	Max. RPM		Item no.	EDP no.
4-1/2	3/4	7/8	CO-COOL 60 / A 100 G	5,000 – 5,800	13,300	5	44695101	43297
			CO-COOL 80 / A 180 M	5,000 – 5,800	13,300	5	44695102	43298
			CO-COOL 120 / A 240 F	5,000 – 5,800	13,300	5	44695103	43299
5	3/4	7/8	CO-COOL 60 / A 100 G	4,600 – 5,300	12,200	5	44695111	43300
			CO-COOL 80 / A 180 M	4,600 – 5,300	12,200	5	44695112	43301
			CO-COOL 120 / A 240 F	4,600 – 5,300	12,200	5	44695113	43302

Threaded arbor hole

4-1/2	3/4	5/8-11	CO-COOL 60 / A 100 G	5,000 – 5,800	13,300	5	47803070	43309
			CO-COOL 80 / A 180 M	5,000 – 5,800	13,300	5	47803071	43310

Continued on next page

Non-woven products

POLIVLIES® flap discs



D [Inch]	T [Inch]	H [Inch]	Abrasive/grit size	Opt. RPM	Max. RPM		Item no.	EDP no.
4-1/2	3/4	5/8-11	CO-COOL 120 / A 240 F	5,000 – 5,800	13,300	5	47803072	43311
5	3/4	5/8-11	CO-COOL 60 / A 100 G	4,600 – 5,300	12,200	5	47803073	43312
			CO-COOL 80 / A 180 M	4,600 – 5,300	12,200	5	47803074	43313
			CO-COOL 120 / A 240 F	4,600 – 5,300	12,200	5	47803075	43314



POLIVLIES® hook and loop discs

POLIVLIES® hook and loop discs are suited to grinding large surfaces. The pre-punched holes mean that they can be ideally centred on and used with various backing pads.

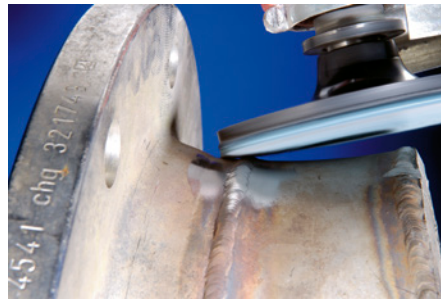

Special features:

- High cost-effectiveness due to high abrasive performance and long service life. Highly flexible, enabling optimal adjustment to contours.
- Creates a consistently high surface quality throughout the entire service life, as new sharp abrasive material is constantly exposed.
- Please order POLIVLIES® hook and loop disc holders separately. Break out the pre-punched centering hole if required.

D ₁ [Inch]	Abrasive	Grit size	Opt. RPM	Max. RPM	Suitable arbors		Item no.	EDP no.
4-1/2	A	100 G	3,300	5,300	47201449	10	42871306	43446
		180 M	3,300	5,300	47201449	10	42871310	43447
		240 F	3,300	5,300	47201449	10	42871318	43449
5	A	100 G	3,000	4,850	47201450	10	42871406	43450
		180 M	3,000	4,850	47201450	10	42871410	43451
		240 F	3,000	4,850	47201450	10	42871418	43453
7	A	100 G	2,200	3,500	47201452	10	42871606	43458
		180 M	2,200	3,500	47201452	10	42871610	43459
		240 F	2,200	3,500	47201452	10	42871618	43461

Hook and loop disc holders



POLIVLIES® hook and loop disc holders

Backing pads for POLIVLIES® hook and loop discs.

Special features:

- Reduced down time due to quick changes.
- Enables surface finishing without visible transitions.

D [Inch]	Thread	Max. RPM		Item no.	EDP no.
Without centering pin					
4-1/2	5/8-11	5,300	1	47201449	43410
5	5/8-11	4,850	1	47201450	43412
7	5/8-11	3,500	1	47201452	43420



POLIVLIES® hook and loop disc holders with centering pin

Backing pads for POLIVLIES® hook and loop discs.

Special features:

- Centering pin enables faster central clamping.
- Reduced down time due to quick changes.
- Enables surface finishing without visible transitions.

D [Inch]	Thread	Max. RPM		Item no.	EDP no.
With centering pin					
4-1/2	5/8-11	5,300	1	47601217	43407
5	5/8-11	4,850	1	47601218	43408
7	5/8-11	3,500	1	47601219	43409

POLICLEAN® products

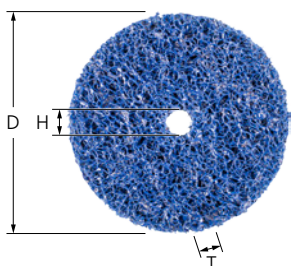

POLICLEAN® PLUS wheels

POLICLEAN® PLUS is a coarsely structured, abrasive, non-woven cleaning fabric that was developed from a special combination of synthetic fibres and abrasive grain. For coarse cleaning work, such as removing paint, scale, heat discoloration, rust and adhesive residue.



Special features:

- Considerably higher stock removal rate, very good service life and very high aggressive performance.
- High flexibility and open structure mean optimal adaptation to contours and no loading of the product itself.
- Please order compatible arbor separately.

D [Inch]	T [Inch]	H [Inch]	Opt. RPM	Max. RPM	Suitable arbors		Item no.	EDP no.
3	1/2	1/4	4,000 – 5,100	10,000	33700108, 33700109, 33700113, 33700114	6	44692076	44790
4	1/2	1/2	3,000 – 3,800	7,500	33700108, 33700109, 33700113, 33700114	4	44692101	44791
6	1/2	1/2	2,000 – 2,500	5,100	33700108, 33700109, 33700113, 33700114	4	44692151	44792

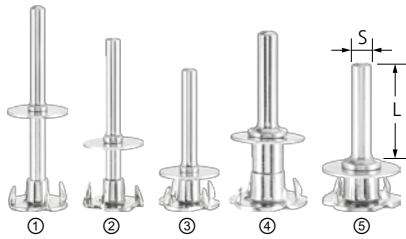

Drive arbors for POLICLEAN® PLUS wheels

Arbor for POLICLEAN® wheels. The different variants provide space for one or two discs.

Special features:

- Allows for quick and easy wheel changes.
- When replacing the discs, leave the arbor clamped in the tool drive.

Suitable for hole diameter [Inch]	S [Inch]	L [Inch]	Matching tool	Version		Item no.	EDP no.
1/2	1/4	1-1/2	44692076, 44692101, 44692151	Packaging, 1x	1	33700108	44835
				Packaging, 2x	1	33700109	44836
	3/8	1-1/2	44692076, 44692101, 44692151	Packaging, 1x	1	33700113	44838
				Packaging, 2x	1	33700114	44839

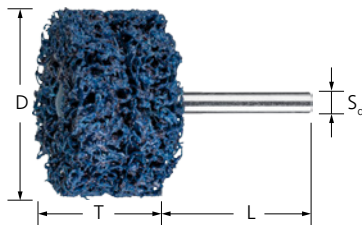

POLICLEAN® PLUS mounted wheels

POLICLEAN® PLUS is a coarsely structured, abrasive, non-woven cleaning fabric that was developed from a special combination of synthetic fibres and abrasive grain. For coarse cleaning work, such as removing paint, scale, heat discoloration, rust and adhesive residue.

Special features:

- The POLICLEAN® PLUS material exhibits considerably higher stock removal rates with a long service life, and is also very aggressive.
- High flexibility and open structure mean optimal adaptation to contours and no loading of the product itself.

D [Inch]	T [Inch]	S _d [Inch]	L [Inch]	H [Inch]	Opt. RPM	Max. RPM		Item no.	EDP no.
2	1/2	1/4	1-1/2	1/4	6,000 – 7,000	15,000	5	47803116	44884
	1	1/4	1-1/2	1/4	6,000 – 7,000	15,000	5	47803117	44885
3	1/2	1/4	1-1/2	1/4	4,000 – 5,100	10,000	5	47803118	44886
	1	1/4	1-1/2	1/4	4,000 – 5,100	10,000	5	47803119	44887
4	1/2	1/4	1-1/2	1/4	3,000 – 3,800	7,500	5	47803120	44888



POLICLEAN® PLUS discs

POLICLEAN® PLUS is a coarsely structured, abrasive, non-woven cleaning fabric that was developed from a special combination of synthetic fibres and abrasive grain.

Special features:

- Considerably higher stock removal rate, very good service life and very high aggressive performance.
- High flexibility and open structure mean optimal adaptation to contours and no loading of the product itself.
- Please order compatible arbor separately.

D [Inch]	T [Inch]	H [Inch]	Opt. RPM	Max. RPM		Item no.	EDP no.
4-1/2	1/2	7/8	5,000 – 7,000	10,000	5	44692716	44874
		5/8-11	5,000 – 7,000	10,000	5	47803076	44879
5	1/2	7/8	5,000 – 7,000	10,000	5	44692726	44875
		5/8-11	5,000 – 7,000	10,000	5	47803077	44880

Explanation of the code system according to EN 12413:

D	= Mounted point outer dia.
T	= Mounted point width
S_d	= Shank dia.
L_0	= Unsupported shank length
L_2	= Shank length
L_3	= Clamping length of shank
①	= collet

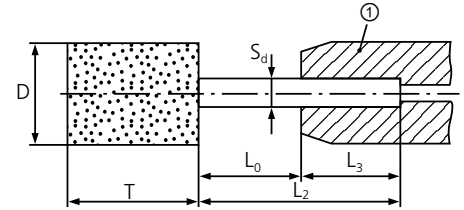

Safety notes

The maximum rotational speeds for the various shank lengths and shank diameters are defined in DIN 69170 based on EN 12413. These must be adhered to in order to avoid buckling of the shank during use. Regardless of the length of the shank, the clamping length (L_3) of the shank must be at least 1/2". Each packaging unit of PFERD mounted points contains the rotational speed specifications for the unsupported shank length (L_0) of that mounted point. Proper concentric accuracy and correct clamping of the tool drive must also be ensured. Tables with the maximum permitted rotational speeds for the entire PFERD mounted point product range are available on request.

The maximum permitted rotational speed is determined by the following factors:

- Shape and dimensions of the mounted point
- Diameter of the steel shank S_d
- Unsupported shank length L_0



Wear eye protection!



Wear hearing protection!



Wear gloves!



Wear a dust mask!



Follow the safety instructions!



Quick product selection guide

① Material group

Select the material to be machined.

② Application

Select the application.



③ Desired surface

Select your desired surface finish.

④ Bond

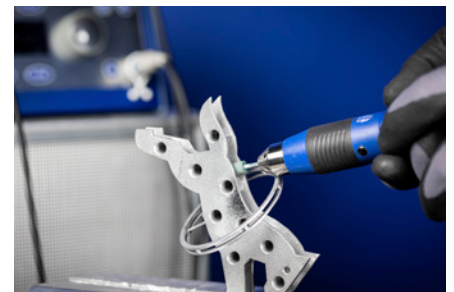
After determining the application (see column ②), the appropriate bond is shown in the horizontal row.



					Bond ▶	
					Elastomer bond	
					Abrasive (grain mixtures) ▶	
					AR	AW
					 	
					GR	LR
④ Designation/bond ▶					GR	LR
Recommended peripheral speed ▶					2,000–2,400 SFPM	2,000–3,000 SFPM
① Material group ▼					② Application ▼	③ Surface ▼
Steel, cast steel	Steels up to 370 HV (< 38 HRC)	Construction steels, carbon steels, tool steels, non-alloyed steels, case-hardened steels, tempering steels, cast steel	Surface	Matte	○	
				Shiny	●	○
			Edge	Matte	○	
	Shiny					
	Hardened, heat-treated steels over 370 HV (> 38 HRC)	Tool steels, tempering steels, alloyed steels, alloyed cast steel	Surface	Matte	○	
				Shiny	○	●
Edge			Matte			
	Shiny					
Stainless steel (INOX)	Rust and acid-resistant steels	Austenitic and ferritic stainless steels	Surface	Matte		
				Shiny	●	○
			Edge	Matte		
				Shiny		○
Universal	Structured					
Non-ferrous metals	Soft non-ferrous metals, non-ferrous metals	Aluminum alloys, brass, copper, zinc	Surface	Matte		
				Shiny	○	●
			Edge	Matte		
	Shiny	○		●		
	Hard non-ferrous metals	Bronze, titanium, titanium alloys, hard aluminum alloys (high Si content)	Surface	Matte		
				Shiny	○	
Edge			Matte			
	Shiny					
High-temperature-resistant materials	Nickel-based and cobalt-based alloys (engine and turbine construction)	Surface	Matte			
			Shiny	●		
		Edge	Matte			
Shiny						

● = highly recommended ○ = recommended

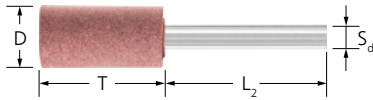

Poliflex® finishing points series W

This bond is a soft elastomer-based bond with pink aluminum oxide. Suitable for use on surfaces. Grinding point in cylindrical shape, for fine grinding of small surfaces.

Special features:

- Soft grinding due to soft, elastic bond.
- Produces a fine, shiny surface finish.

Shape	D [Inch]	T [Inch]	S _d [Inch]	L ₂ [Inch]	Abrasive	Grit size	Opt. RPM 1/2" overhang	Max. RPM 1/2" overhang	Max. RPM 1" overhang		Item no.	EDP no.
Shank diameter 1/8"												
W 162	1/4	3/8	1/8	1-1/4	A	120	36,000	67,210	44,040	10	41803112	36101
W 168	5/16	5/16	1/8	1-1/4	A	120	29,000	65,900	42,790	10	41805112	36111
W 170	5/16	1/2	1/8	1-1/4	A	120	29,000	54,860	34,040	10	47000801	36121
W 174	3/8	1/4	1/8	1-1/4	A	120	24,000	65,510	42,440	10	47000702	36131
W 175	3/8	3/8	1/8	1-1/4	A	120	24,000	57,530	35,990	10	47000510	36141
W 176	3/8	5/8	1/8	1-1/4	A	120	24,000	50,460	30,450	10	47000676	36151
W 185	1/2	1/2	1/8	1-1/4	A	120	18,000	42,750	24,370	10	47000707	36171
Shank 1/4 "												
W 178	3/8	1	1/4	1-1/2	A	120	24,000	40,360	30,780	10	47000596	36191
W 193	5/8	3/8	1/4	1-1/2	A	120	14,500	44,330	34,340	10	47000759	36231
W 196	5/8	1	1/4	1-1/2	A	120	14,500	34,670	24,340	10	47000842	36251
W 204	3/4	3/4	1/4	1-1/2	A	120	12,000	36,510	27,040	10	47000711	36281
W 220	1	1	1/4	1-1/2	A	120	9,000	30,370	21,410	10	47000751	36311
W 230	1-1/4	1-1/4	1/4	1-1/2	A	120	7,200	25,200	16,760	5	41830112	36331

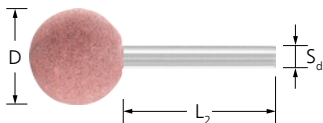

Series A and B

Poliflex® finishing points with the rubber bond are manufactured with pink aluminum oxide. The rubber (GR) bond is an elastomer-based soft bond. Ideal for use on surfaces.

Special features:

- Soft grinding due to soft, elastic bond.
- Produces a fine, shiny surface finish.

Shape	D [Inch]	S _d [Inch]	L ₂ [Inch]	Abrasive	Grit size	Opt. RPM 1/2" overhang	Max. RPM 1/2" overhang	Max. RPM 1" overhang		Item no.	EDP no.
Shank diameter 1/8"											
B 125	5/16	1/8	1-1/4	A	120	36,000	75,330	50,640	10	47000482	36401
B 122	3/8	1/8	1-1/4	A	120	24,000	68,740	37,790	10	47000706	36361
Shank diameter 1/4"											
B 121	1/2	1/4	1-1/2	A	120	18,000	69,310	45,850	10	47000745	36421
A 26	3/5	1/4	1-1/2	A	120	14,000	49,980	40,410	10	47000594	36431
A 40	3/4	1/4	1-1/2	A	120	12,000	50,930	50,930	10	47000595	36441
A 25	1	1/4	1-1/2	A	120	9,000	35,510	28,840	10	47000593	36451

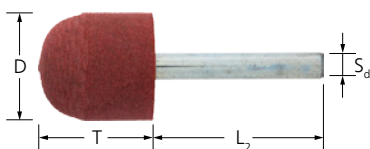

Series A

Poliflex® finishing points with the rubber bond are manufactured with pink aluminum oxide. The rubber (GR) bond is an elastomer-based soft bond. Ideal for use on surfaces.

Special features:

- Soft grinding due to soft, elastic bond.
- Produces a fine, shiny surface finish.

Shape	D [Inch]	T [Inch]	S _d [Inch]	L ₂ [Inch]	Abrasive	Grit size	Opt. RPM 1/2" overhang	Max. RPM 1/2" overhang	Max. RPM 1" overhang		Item no.	EDP no.
Shank diameter 1/4"												
A 21	1	1	1/4	1-1/2	A	120	9,000	35,510	28,840	10	47000592	36491



Poliflex® finishing products

Rubber bond

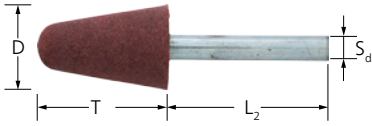

Series A

Poliflex® finishing points with the rubber bond are manufactured with pink aluminum oxide. The rubber (GR) bond is an elastomer-based soft bond. Ideal for use on surfaces.

Special features:

- Soft grinding due to soft, elastic bond.

- Produces a fine, shiny surface finish.

Shape	D [Inch]	T [Inch]	S _d [Inch]	L ₂ [Inch]	Abrasive	Grit size	Opt. RPM 1/2" overhang	Max. RPM 1/2" overhang	Max. RPM 1" overhang		Item no.	EDP no.
Shank diameter 1/4"												
A 12	11/16	1-1/6	1/4	1-1/2	A	120	13,000	38,050	30,790	10	47000591	36481

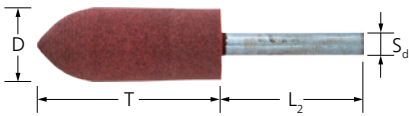

Series A and B

Poliflex® finishing points with the rubber bond are manufactured with pink aluminum oxide. The rubber (GR) bond is an elastomer-based soft bond. Ideal for use on surfaces.

Special features:

- Soft grinding due to soft, elastic bond.

- Produces a fine, shiny surface finish.

Shape	D [Inch]	T [Inch]	S _d [Inch]	L ₂ [Inch]	Abrasive	Grit size	Opt. RPM 1/2" overhang	Max. RPM 1/2" overhang	Max. RPM 1" overhang		Item no.	EDP no.
Shank diameter 1/4"												
B 52	3/8	3/4	1/4	1-1/2	A	120	24,000	78,340	54,390	10	47000651	36501
A 5	3/4	1-1/8	1/4	1-1/2	A	120	12,000	38,550	31,270	10	47000589	36461
A 11	7/8	2	1/4	1-1/2	A	120	10,000	25,420	20,100	10	47000590	36471

Leather bond

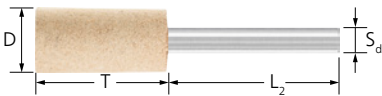

Poliflex® finishing points series W

Poliflex® finishing points with the leather bond are manufactured with white aluminum oxide. The leather (LR) bond is a hard, sturdy bond. Ideal for use on surfaces.



Special features:

- Produces a fine, shiny surface finish.
- Cost-effective due to high abrasive performance and durability.

Shape	D [Inch]	T [Inch]	S _d [Inch]	L ₂ [Inch]	Abrasive	Grit size	Opt. RPM 1/2" overhang	Max. RPM 1/2" overhang	Max. RPM 1" overhang		Item no.	EDP no.
Shank diameter 1/8"												
W 162	1/4	3/8	1/8	1-1/4	A	120	60,000	67,210	44,040	10	47000729	36105
W 168	5/16	5/16	1/8	1-1/4	A	120	48,000	65,900	42,790	10	47000843	36115
W 170	5/16	1/2	1/8	1-1/4	A	120	48,000	54,860	34,040	10	41807212	36125
W 174	3/8	1/4	1/8	1-1/4	A	120	40,000	65,510	42,440	10	47000757	36135
W 176	3/8	5/8	1/8	1-1/4	A	120	40,000	50,460	30,450	10	47000607	36155
W 185	1/2	1/2	1/8	1-1/4	A	120	30,000	42,750	23,370	10	47000809	36175

Continued on next page

Shape	D [Inch]	T [Inch]	S _d [Inch]	L ₂ [Inch]	Abrasive	Grit size	Opt. RPM 1/2" overhang	Max. RPM 1/2" overhang	Max. RPM 1" overhang		Item no.	EDP no.
W 186	1/2	3/4	1/8	1-1/4	A	120	30,000	31,220	15,900	10	47000758	36185
Shank diameter 1/4 Inch												
W 178	3/8	1	1/4	1-1/2	A	120	40,000	40,360	30,780	10	47000653	36195
W 193	3/5	3/8	1/4	1-1/2	A	120	24,000	44,330	34,340	10	47000760	36235
W 196	3/5	1	1/4	1-1/2	A	120	24,000	34,670	25,340	10	47000804	36255
W 204	3/4	3/4	1/4	1-1/2	A	120	24,000	36,510	27,040	10	41824212	36285
W 206	3/4	1-1/6	1/4	1-1/2	A	120	20,000	29,810	20,870	10	41826212	36295
W 220	1	1	1/4	1-1/2	A	120	15,000	30,370	21,410	10	47000798	36315
W 230	1-1/6	1-1/4	1/4	1-1/2	A	120	13,000	25,200	16,760	5	41830212	36335

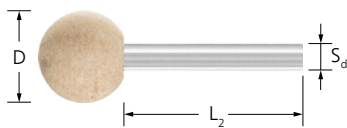

Series A and B

Poliflex® finishing points with the leather bond are manufactured with white aluminum oxide. The leather (LR) bond is a hard, sturdy bond. Ideal for use on surfaces.



Special features:

- Produces a fine, shiny surface finish.
- Cost-effective due to high abrasive performance and durability.

Shape	D [Inch]	S _d [Inch]	L ₂ [Inch]	Abrasive	Grit size	Opt. RPM 1/2" overhang	Max. RPM 1/2" overhang	Max. RPM 1" overhang		Item no.	EDP no.
Shank diameter 1/8"											
B 125	5/16	1/8	1-1/4	A	120	60,000	75,330	50,640	10	47000483	36405
B 122	3/8	1/8	1-1/4	A	120	40,000	68,740	37,790	10	47000485	36365
B 121	1/2	1/4	1-1/2	A	120	30,000	69,310	45,850	10	47000761	36425
A 26	3/5	1/4	1-1/2	A	120	24,000	48,980	40,410	10	47000602	36435
A 25	1	1/4	1-1/2	A	120	15,000	35,510	28,840	10	47000601	36455

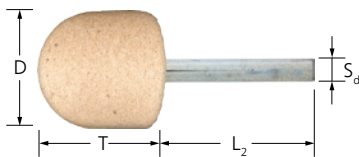

Series A

Poliflex® finishing points with the leather bond are manufactured with white aluminum oxide. The leather (LR) bond is a hard, sturdy bond. Ideal for use on surfaces.

Special features:

- Produces a fine, shiny surface finish.
- Cost-effective due to high abrasive performance and durability.

Shape	D [Inch]	T [Inch]	S _d [Inch]	L ₂ [Inch]	Abrasive	Grit size	Opt. RPM 1/2" overhang	Max. RPM 1/2" overhang	Max. RPM 1" overhang		Item no.	EDP no.
Shank diameter 1/4"												
A 21	1	1	1/4	1-1/2	A	120	15,000	35,510	28,840	10	47000600	36495



Poliflex® finishing products

Leather bond

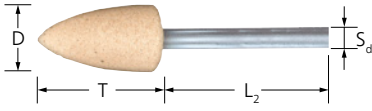

Series A

Poliflex® finishing points with the leather bond are manufactured with white aluminum oxide. The leather (LR) bond is a hard, sturdy bond. Ideal for use on surfaces.

Special features:

- Produces a fine, shiny surface finish.

- Cost-effective due to high abrasive performance and durability.

Shape	D [Inch]	T [Inch]	S _d [Inch]	L ₂ [Inch]	Abrasive	Grit size	Opt. RPM 1/2" overhang	Max. RPM 1/2" overhang	Max. RPM 1" overhang		Item no.	EDP no.
A 12	11/16	1-1/4	1/4	1-1/2	A	120	22,000	38,050	30,790	10	47000599	36485

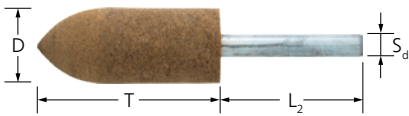

Series A and B

Poliflex® finishing points with the leather bond are manufactured with white aluminum oxide. The leather (LR) bond is a hard, sturdy bond. Ideal for use on surfaces.

Special features:

- Produces a fine, shiny surface finish.

- Cost-effective due to high abrasive performance and durability.

Shape	D [Inch]	T [Inch]	S _d [Inch]	L ₂ [Inch]	Abrasive	Grit size	Opt. RPM 1/2" overhang	Max. RPM 1/2" overhang	Max. RPM 1" overhang		Item no.	EDP no.
B 52	3/8	3/4	1/4	1-1/2	A	120	40,000	78,340	54,390	10	47000652	36505
A 5	3/4	1-1/8	1/4	1-1/2	A	120	20,000	38,550	31,270	10	47000597	36465
A 11	7/8	2	1/4	1-1/2	A	120	17,000	24,420	20,100	10	47000598	36475

TX bond



TX INOX + ALU

Very hard, sturdy bond made of regular aluminum oxide with textile fabric inlays. Suitable for fine face-down grinding on large surfaces.

Special features:

- Produces a fine, matte surface finish.

- Cost-effective due to high abrasive performance and durability.

D [Inch]	T [Inch]	H [Inch]	Abrasive	Grit size	Max. RPM		Item no.	EDP no.
4-1/2	1/4	7/8	A	36	13,300	10	69901219	61433
				54	13,300	10	69901220	61434
		5/8-11	A	36	13,300	10	69901221	61442
				54	13,300	10	69901222	61443

Safety notes

- For safety reasons, the maximum permitted rotational speed indicated must never be exceeded.



Wear eye protection!



Wear hearing protection!



Wear gloves!



Wear a dust mask!



Follow the safety instructions!



Felt points

4

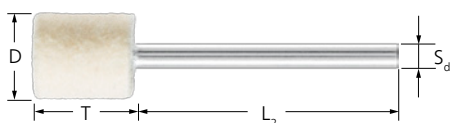

Cylindrical shape

The cylindrical shape is mainly used peripherally for pre-polishing and high-gloss polishing. Can be profiled as desired, meaning they can also be used on workpieces with complex geometries. Precise retention of geometric shapes due to the hardness of these points.

Special features:

- Use diamond polishing pastes and polishing paste bars. Please order separately.

D [Inch]	T [Inch]	S _d [Inch]	L ₂ [Inch]	Version	Opt. RPM	Max. RPM		Item no.	EDP no.
Shank diameter 1/8"									
1/4	3/8	1/8	1-5/8	M (medium)	16,000 – 32,000	79,500	10	47901186	48520
5/16	3/8	1/8	1-5/8	M (medium)	12,000 – 24,000	59,500	10	47901187	48521
3/8	9/16	1/8	1-5/8	M (medium)	10,000 – 20,000	47,500	10	47901188	48522
Shank diameter 1/4"									
3/8	9/16	1/4	1-5/8	M (medium)	10,000 – 20,000	47,500	10	47901189	48523

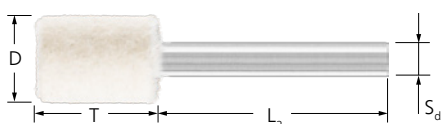

Cylindrical shape

The cylindrical shape is mainly used face-down for pre-polishing and high-gloss polishing. Can be profiled as desired, meaning they can also be used for products with complex geometries. Precise retention of geometric shapes due to the hardness of these points.

Special features:

- Use diamond polishing pastes and polishing paste bars. Please order separately.

- Ideal for face-down use.

D [Inch]	T [Inch]	S _d [Inch]	L ₂ [Inch]	Version	Opt. RPM	Max. RPM		Item no.	EDP no.
Shank diameter 1/4" – with end hole									
9/16	3/4	1/4	1-5/8	M (medium)	6,000 – 12,000	31,500	10	47901190	48524
3/4	1	1/4	1-5/8	M (medium)	5,000 – 10,000	23,500	10	47901191	48525
1	1-1/4	1/4	1-5/8	M (medium)	4,000 – 8,000	19,000	10	47901192	48526

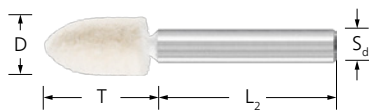

Conical pointed shape

Conical pointed shape

Special features:

- Precise retention of geometric shapes due to the hardness of these products.

- Can be freely shaped, meaning they can be used on complicated geometries.
- Use diamond polishing pastes and polishing paste bars. Please order separately.

D [Inch]	T [Inch]	S _d [Inch]	L ₂ [Inch]	Version	Opt. RPM	Max. RPM		Item no.	EDP no.
Shank diameter 1/8"									
5/16	1/2	1/8	1-5/8	M (medium)	12,000 – 24,000	59,500	10	47901197	48570
3/8	3/4	1/8	1-5/8	M (medium)	10,000 – 20,000	47,500	10	47901198	48571
1/2	3/4	1/8	1-5/8	M (medium)	8,000 – 16,000	39,500	10	47901200	48573
Shank diameter 1/4"									
3/8	3/4	1/4	1-5/8	M (medium)	10,000 – 20,000	47,500	10	47901199	48572
9/19	3/4	1/4	1-5/8	M (medium)	6,000 – 12,000	31,500	10	47901201	48574
	1-1/6	1/4	1-5/8	M (medium)	6,000 – 12,000	31,500	10	47901202	48575
3/4	1	1/4	1-5/8	M (medium)	5,000 – 10,000	23,500	10	47901203	48576

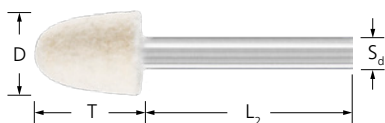

Conical shape with radius end

The conical shape with radius end is mainly used for pre-polishing and high-gloss polishing of radii.



Special features:

- Precise retention of geometric shapes due to the hardness of these products.
- Can be freely shaped, meaning they can be used on complicated geometries.
- Use diamond polishing pastes and polishing paste bars. Please order separately.

D [Inch]	T [Inch]	S _d [Inch]	L ₂ [Inch]	Version	Opt. RPM	Max. RPM		Item no.	EDP no.
Shank diameter 1/4"									
9/16	3/4	1/4	1-5/8	M (medium)	6,000 – 12,000	31,500	10	47901204	48600
3/4	1	1/4	1-5/8	M (medium)	5,000 – 10,000	23,500	10	47901205	48601
1	1-1/4	1/4	1-5/8	M (medium)	4,000 – 8,000	19,000	10	47901206	48602
1-1/4	1-3/8	1/4	1-5/8	M (medium)	3,000 – 6,000	15,500	10	47901207	48603

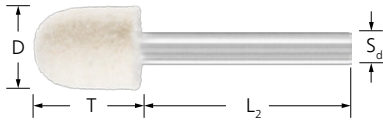

Cylindrical shape with radius end

The cylindrical shape with radius end is mainly used for pre-polishing and high-gloss polishing of small, concave contours.

Special features:

- Precise retention of geometric shapes due to the hardness of these products.
- Can be freely shaped, meaning they can be used on complicated geometries.
- Use diamond polishing pastes and polishing paste bars. Please order separately.

D [Inch]	T [Inch]	S _d [Inch]	L ₂ [Inch]	Version	Opt. RPM	Max. RPM		Item no.	EDP no.
Shank diameter 1/8"									
5/16	1/2	1/8	1-5/8	M (medium)	12,000 – 24,000	59,900	10	47901208	48630
3/8	9/16	1/8	1-5/8	M (medium)	10,000 – 20,000	47,500	10	47901209	48631
Shank diameter 1/4"									
9/16	3/4	1/4	1-5/8	M (medium)	6,000 – 12,000	31,500	10	47901210	48632
3/4	1	1/4	1-5/8	M (medium)	5,000 – 10,000	23,500	10	47901211	48633
1	1-1/4	1/4	1-5/8	M (medium)	4,000 – 8,000	19,000	10	47901212	48634



Mounted felt flap wheels

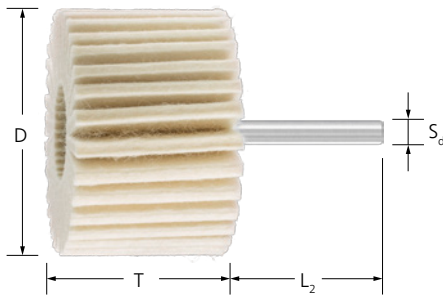

Mounted felt flap wheels

Mounted felt flap wheels are used for pre-polishing and high-gloss polishing on small to medium sized components. Use the hard (H) for pre-polishing flat surfaces, and the soft (W) for high-gloss polishing and processing workpieces with lots of contours.



Special features:

- Optimum adaptation to contours due to high flexibility. Cool grinding and low thermal load of the workpiece.
- If very fine finishes need to be achieved, the two types can be used successively.
- Use a polishing paste bar. Please order separately.

D [Inch]	T [Inch]	S _d [Inch]	L ₂ [Inch]	Version	Opt. RPM	Max. RPM		Item no.	EDP no.
1	3/8	1/4	1-1/2	W (soft)	7,500	24,500	5	47901224	48540
	1	1/4	1-1/2	W (soft)	7,500	24,500	5	47901226	48542
				H (hard)	7,500	24,500	5	47901225	48543
2	1	1/4	1-1/2	W (soft)	3,800	12,000	5	47901228	48546
				H (hard)	3,800	12,000	5	47901227	48547
3	1	1/4	1-1/2	W (soft)	2,400	7,500	5	47901230	48550
				H (hard)	2,400	7,500	5	47901229	48551
	2	1/4	1-1/2	W (soft)	2,400	7,500	5	47901232	48552
				H (hard)	2,400	7,500	5	47901231	48553

Polishing tools

Felt wheels

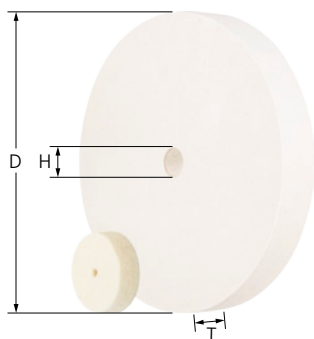

Felt wheels

Felt wheels are mainly used on edge.



Special features:

- Precise retention of geometric shapes due to the hardness of these products.
- Use diamond polishing pastes and polishing paste bars. Please order polishing pastes and compatible arbor separately.

D [Inch]	T [Inch]	H [Inch]	Version	Opt. RPM	Max. RPM	Suitable arbors		Item no.	EDP no.
Discs									
1-1/4	1/4	1/4	M (medium)	3,000 – 6,000	20,000	33700132	5	44101742	48690
1-3/4	3/8	1/4	M (medium)	2,000 – 4,000	13,500	33700132	5	44101732	48691
2-1/4	3/8	1/4	M (medium)	1,500 – 3,000	10,000	33700132	5	44316010	48692
3	3/8	3/8	M (medium)	1,000 – 2,000	7,500	33700093	5	44367010	48693
4	3/4	3/8	M (medium)	900 – 1,800	6,100	33700139	1	44367110	48695
5	3/4	3/4	M (medium)	750 – 1,500	4,900	33700140	1	44367220	48697
6	1	3/4	M (medium)	600 – 1,200	4,000	33700140	1	44367320	48699
8	1-1/4	3/4	M (medium)	500 – 1,000	3,000	33700140	1	44367420	48700

Felt flap discs



Felt flap discs

Felt flap discs are used for pre-polishing and high-gloss polishing on medium-sized to large components.



Special features:

- Optimum adaptation to contours due to high flexibility. Cool grinding and low thermal load of the workpiece.
- Use a polishing paste bar. Please order separately.

D [Inch]	T [Inch]	H [Inch]	Version	Opt. RPM	Max. RPM		Item no.	EDP no.
4-1/2	7/8	7/8	W (soft)	1,650	8,350	5	44370115	48802
			H (hard)	1,650	8,350	5	44371115	48803
5	7/8	7/8	W (soft)	1,500	7,650	5	44370125	48804
			H (hard)	1,500	7,650	5	44371125	48805

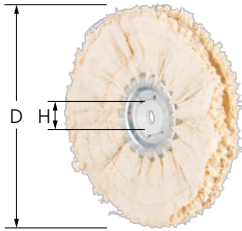

Cloth rings with hole, ST type

For coarse pre-polishing with polishing pastes. Please order corresponding polishing pastes and arbor separately.

Special features:

- Highly flexible, enabling optimal adaptation to the workpiece contour.
- ST (sisal cloth) = Coarse pre-polishing

D [Inch]	Usage width [Inch]	H [Inch]	Opt. RPM	Max. RPM	Suitable arbors		Item no.	EDP no.
3	3/4	3/8	2,500	7,500	33700093	5	44270802	48710
4	3/4	3/8	1,900	6,100	33700093	5	44271003	48711
6	1	3/4	1,250	4,000	33700140	5	44271503	48713
8	1	3/4	950	3,000	33700140	5	44272003	48714

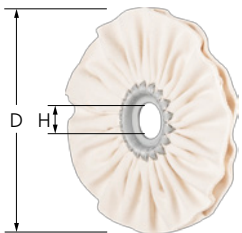

Cloth rings with hole, TH type

For pre-polishing with polishing pastes. Please order corresponding polishing pastes and arbor separately.

Special features:

- Conforms to contours due to high flexibility.
- The hard cloth enables pre-polishing.

D [Inch]	Usage width [Inch]	H [Inch]	Opt. RPM	Max. RPM	Suitable arbors		Item no.	EDP no.
3	3/8	3/8	2,500	7,500	33700093	5	44270803	48720
4	3/8	3/8	1,900	6,100	33700093	5	44271004	48721
6	3/8	3/4	1,250	4,000	33700140	5	44271504	48723
8	3/8	3/4	950	3,000	33700140	5	44272004	48724

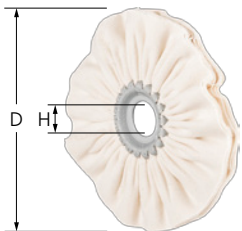

Cloth rings with hole, TW type

For high-gloss polishing with polishing pastes. Please order polishing pastes and arbor separately.

Special features:

- The soft cloth enables high-gloss polishing.
- Conforms to contours due to high flexibility.

D [Inch]	Usage width [Inch]	H [Inch]	Opt. RPM	Max. RPM	Suitable arbors		Item no.	EDP no.
3	3/8	3/8	2,500	7,500	33700093	5	44270804	48730
4	3/8	3/8	1,900	6,100	33700093	5	44271005	48731
6	3/8	3/4	1,250	4,000	33700140	5	44271505	48733
8	3/8	3/4	950	3,000	33700140	5	44272005	48734



Polishing tools

Cloth rings

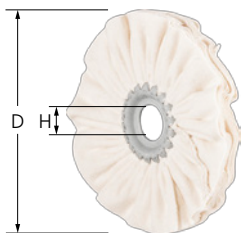

Cloth rings with hole, FL type

For high-gloss polishing with polishing pastes. Please order polishing pastes and arbor separately.

Special features:

- Conforms to contours due to high flexibility.
- The flannel cloth enables high-gloss polishing and buffing.

D [Inch]	Usage width [Inch]	H [Inch]	Opt. RPM	Max. RPM	Suitable arbors		Item no.	EDP no.
3	3/8	3/8	2,500	7,500	33700093	5	44270805	48740
4	3/8	3/8	1,900	6,100	33700093	5	44271006	48741
6	3/8	3/4	1,250	4,000	33700140	5	44271506	48743
8	3/8	3/4	950	3,000	33700140	5	44272006	48744

4

Arbor

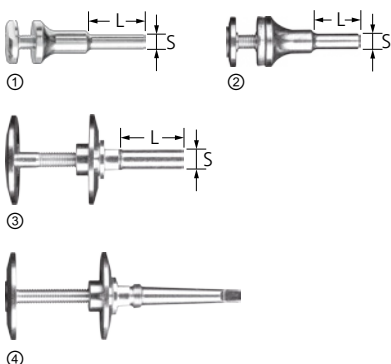

Arbor for felt wheels and cloth rings BO

Matching arbors for felt wheels and cloth rings.

Special features:

- Reduced down time due to quick changes.

Image	Suitable for hole diameter [Inch]	S [Inch]	L [Inch]	Clamping width [Inch]		Item no.	EDP no.
(1)	1/2, 5/8	1/4	-	1/8 – 1/2	1	79184656	84656
(2)	3/8	1/4	7/8	0 – 5/16	1	33700093	69027
(3)	1/4	1/4	1	1/8 – 1/4	1	33700132	69029
(4)	1/2, 3/4	3/8	1	1/4 – 1	1	33700140	69032

Cloth ring drum

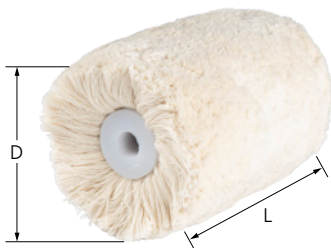

Special features:

- Conforms to contours due to high flexibility.
- Can be freely shaped, meaning they can be used on complicated geometries.

D [Inch]	Usage width [Inch]	Thread	Opt. RPM	Max. RPM		Item no.	EDP no.
4	4	5/8-11	3,500	3,500	1	47900076	48842



Grinding pastes

Oil-soluble grinding pastes with sharp-edged SiC grain.



Special features:

- High productivity.
- Quick results.
- Specialized system.

Grit size	Contents [oz]	Contents [grams]		Item no.	EDP no.
90	8.82	250	1	44220090	48770
150	8.82	250	1	44220150	48771
280	8.82	250	1	44220280	48772
360	8.82	250	1	44220360	48773
600	8.82	250	1	44220600	48774
800	8.82	250	1	44220800	48775

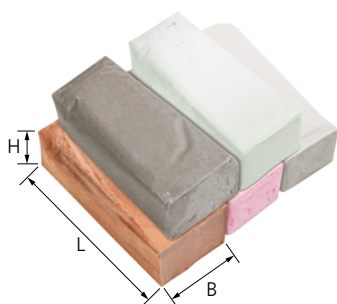

Polishing paste bars

Apart from being used with felt products, polishing pastes are also used in combination with cloth rings and buffing drums for pre-polishing and high-gloss polishing. If the intention is to achieve very smooth surface finishes, use several or even all types successively.



Special features:

- Intended applications for the different types: ST (sisal cloth) = Coarse pre-polishing with green, grey, or brown pastes; TH (hard cloth) = Pre-polishing with green, grey, or brown pastes; TW (soft cloth) = High-gloss polishing with pink or beige pastes; FL (flannel) = High-gloss polishing/buffing with pink or beige pastes
- PP 4, PP 5: Use cloth rings in the TW (soft cloth) version for high-gloss polishing, and cloth rings in the FL (flannel) version for high-gloss polishing/buffing.

Version	Use for	Contents [oz]	Contents [grams]	Color code	B [Inch]	H [Inch]	L [Inch]		Item no.	EDP no.
Bulk pack										
Pre-polishing	Steel + INOX	38.8	1,100	green	2-3/4	2	5-1/2	1	44250001	48760
	Aluminum + brass	45.8	1,300	grey	2-3/4	2	5-1/2	1	44250002	48761
	Non-ferrous metals	40.5	1,150	brown	2-3/4	2	5-1/2	1	44250003	48762
High-gloss polishing	All metals	40.5	1,150	pink	2-3/4	2	5-1/2	1	44250004	48763
	Plastics	38.8	1,100	beige	2-3/4	2	5-1/2	1	44250005	48764
Small pack										
Pre-polishing	Steel + INOX	3.8	108	green	1	1-1/4	3-1/2	1	44250006	48765
	Aluminum + brass	5	142	grey	1	1-1/4	3-1/2	1	44250007	48766
	Non-ferrous metals	3.9	111	brown	1	1-1/4	3-1/2	1	44250008	48767
High-gloss polishing	All metals	4.7	132	pink	1	1-1/4	3-1/2	1	44250009	48768
	Plastics	3.6	104	beige	1	1-1/4	3-1/2	1	44250010	48769



Grinding and polishing pastes

Diamond polishing pastes



Diamond polishing pastes

Diamond polishing pastes are used for work on hard materials, such as tungsten carbide and hardened steels. They are used in combination with felt polishing elements. Diamond polishing pastes can be diluted and dissolved with water and alcohol.

Special features:

- Can be thinned and dissolved with water and alcohol.
- High productivity. Quick results. Coordinated selections of grits.

Grit size [µm]	Contents [fl oz]	Contents [grams]	Colour of sealing cap		Item no.	EDP no.
ECO DPP						
30	0.35	10	brown	1	44240202	48799
15	0.35	10	blue	1	44240192	48798
10	0.35	10	light blue	1	44240182	48797
7	0.35	10	red	1	44240172	48796
3	0.35	10	green	1	44240162	48795
1	0.35	10	yellow	1	44240152	48794

4



Cleaner



Universal cleaner

Highly effective, general workshop cleaner for cleaning and de-greasing components as a preparation for painting. Removes polishing paste residue, processing oils, corrosion-protection oils, light waxes and other types of contamination.



Special features:

- Biodegradable surfactants.
- Short drying time. Non-combustible.
- Versatile.

Contents [fl oz]	Contents [ml]		Item no.	EDP no.
16.9	500	1	42200060	48747

General terms and conditions of sale

Our general terms and conditions of sale apply, which you can view at www.pferd.com/conditions.



Scan the QR code for more information about our general terms and conditions of sale.

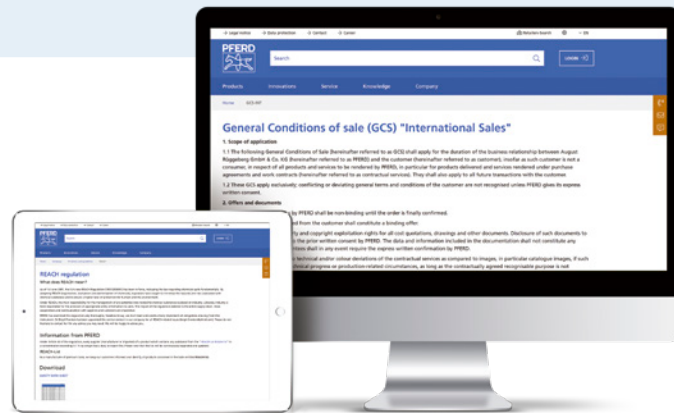

New in the PFERD product range

Our new products have **blue** item numbers in the Tool Manual. Discontinued products are in *italics* and identified accordingly in the corresponding product tables.



Stay up to date and discover our new products digitally and online.

REACH Regulation (EC) No. 1907/2006

By adopting REACH (registration, evaluation and authorisation of chemicals), legislators have sought to minimize the hazards and risks associated with chemical substances and to ensure a higher level of protection for humans and the environment.



Information about PFERD tools in the context of the EC REACH Regulation can be found on our website www.pferd.com/reach.

PFERD repair service

Our highly experienced team at our Marienheide plant in Germany ensures that repairs are carried out quickly and looks after the provision of spare parts. Please send any queries to: pferd.power.tools@pferd.com