

Ceramic oxide grain CO-COOL abrasive

For maximum stock removal



TRUST BLUE

- State-of-the-art abrasive with self-sharpening qualities
- Aggressive grinding with maximum stock removal rate on hard materials which do not conduct heat well
- Active grinding additives in the coating prevent clogging and result in cooler grinding

Ceramic oxide grain CO-COOL abrasive

General information

Ceramic oxide grain is a state-of-the-art abrasive which is used in a variety of areas due to its toughness, grain structure and its resulting self-sharpening qualities. The pointed and sharp-edged grain offers advantages for use on grinding tools and is suitable for aggressive grinding with maximum stock removal rate on hard materials which do not conduct heat well.

A constant high level of performance is achieved through the self-sharpening ceramic oxide grain. The CO-COOL ceramic oxide grain has active grinding additives in the coating which achieve a significantly higher stock removal rate, prevent clogging and result in cooler grinding.

Due to the special structure of the ceramic oxide grain and the active grinding binding components, the abrasive is outstanding for work on stainless steel (INOX), high-alloy steels, titanium, nickel-based and cobalt-based alloys and extremely hard workpiece surfaces.



Advantages:

- State-of-the-art abrasive with self-sharpening qualities.
- Aggressive grinding with maximum stock removal rate on hard materials which do not conduct heat well.
- Active grinding additives in the coating prevent clogging and result in cooler grinding.

Matching tool drives:

- Flexible shaft drives
- Straight grinders
- Angle grinders
- Cordless angle grinders
- Belt grinder
- Burnishing machines

Safety notes:

- Observe the safety recommendations "Safety recommendations for the use of abrasive products" provided by the FEPA (Federation of European Producers of Abrasives). You can find this information on www.pferd.com.

PFERD tools with ceramic oxide grain CO-COOL abrasive

Picture	Designation	Page	Picture	Designation	Page
	COMBICLICK fibre discs	3		POLIROLL cartridge rolls	16
	Fibre discs	5		POLICAP abrasive caps	17
	COMBIDISC abrasive discs	7		Mounted flap wheels	19
	Short belts	11		Unmounted flap wheels	20
	Long belts	12		Unmounted flap wheels for angle grinders	21
	Belts for pneumatic drums	13		POLIVLIES grinding discs	22
	Abrasive spiral bands	14		POLIFAN flap discs	23

Ceramic oxide grain CO-COOL abrasive

COMBICLICK fibre discs CC-FS

Ceramic oxide grain CO-COOL type

Ideally suited for coarse grinding work and step-by-step fine grinding.

Advantages:

- Innovative quick-mounting system guarantees convenient handling and cool grinding.
- High profitability thanks to long tool life and very high stock removal rate.
- Consistent surface finish thanks to high-quality abrasives.

Applications:

levelling, deburring surface work, work on edges, work on weld seams, step-by-step fine grinding

Recommendations for use:

- Use COMBICLICK fibre discs with COMBICLICK backing pads on commercially available angle grinders.
- Use grinding oil which is suitable for the material in order to considerably increase the tool life and abrasive performance of the tools. More detailed information and ordering data for grinding oils can be found in our Tool Manual 23, catalogue section 4, page 155 or on www.pferd.com.
- For particularly flexible performance when face-down grinding, use fibre discs with a diameter of 125 mm.

Safety notes:

- The maximum permitted peripheral speed is 80 m/s.
- For safety reasons, the specified maximum permitted rotational speed must never be exceeded.

Ordering notes:

- When ordering, please state the EAN or the full description.
- Please order COMBICLICK backing pads separately. More detailed information and ordering data for backing pads can be found on page 4.

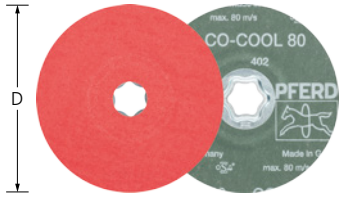

PFERDVALUE:

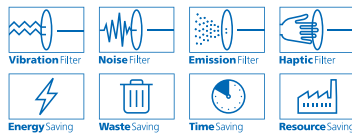

D [mm]	Grit size						Max. RPM		Description
	24	36	50	60	80	120			
	EAN 4007220								
100	-	836149	836163	836187	836194	892442	15,300	25	CC-FS 100 CO-COOL ...
115	763308	763315	763322	763339	763346	763353	13,300	25	CC-FS 115 CO-COOL ...
125	722442	722473	722480	722497	722503	722510	12,200	25	CC-FS 125 CO-COOL ...
180	722534	722558	722565	722589	722602	-	8,500	25	CC-FS 180 CO-COOL ...

Ceramic oxide grain CO-COOL-CONTOUR type

Very flexible and adaptable on account of the outer contour. Cutting into the workpiece is avoided.

Active grinding additives in the coating substantially improve the stock removal rate, prevent clogging and result in cooler grinding.

Recommendations for use:

- Use only the CC-GT 115-125 backing pad with M14 or 5/8" thread to maintain the flexibility at the edge of the fibre discs.

Abrasive:

Ceramic oxide grain CO-COOL-CONTOUR

Ordering notes:

- Please complete the description with the desired grit size.

PFERDVALUE:

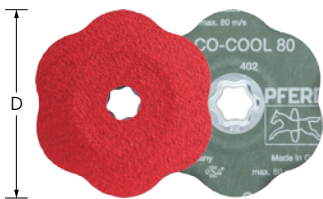
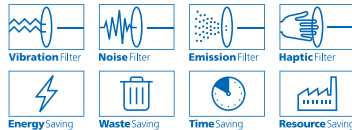

D [mm]	Grit size			Max. RPM		Description
	60	80	120			
	EAN 4007220					
125	416990	417027	417041	12,200	25	CC-FS 125 CO-COOL ... CONTOUR

 Here you will find further details and useful information about the wide range of COMBICLICK tools.

Ceramic oxide grain CO-COOL abrasive COMBICLICK backing pad

CC-GT, CC-H-GT types

With this backing pad, COMBICLICK tools can be used on commercially available angle grinders.

The different hardnesses are colour-coded:

- CC-GT (medium) = black
- CC-H-GT (hard) = blue



Advantages:

- The geometry of the cooling slots significantly reduces the thermal load.
- High economic efficiency due to minimized tool change times.

Recommendations for use:

- Type CC-H-GT is mainly used to work on stainless steel (INOX). It features very high edge strength, which enables a higher contact pressure.

Safety notes:

- The maximum peripheral speed is 80 m/s.
- For backing pads with a diameter of 180 mm, do not apply too high a contact pressure in order to prevent the backing pad from overstretching.

PFERDVALUE:

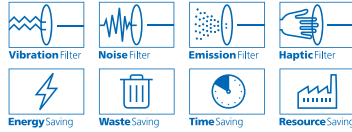

Suitable for CC diameter [mm]	Thread	Hardness	Suitable for machine types	EAN 4007220	Max. RPM		Description
100	M10	medium	Angle grinders 100, spindle M10	836200	15,300	1	CC-GT 100 M10
115, 125	M14	medium	Angle grinders 115 / 125, spindle M14	725764	13,300	1	CC-GT 115-125 M14
		medium	Angle grinders 115 / 125, spindle 5/8"	725771	13,300	1	CC-GT 115-125 5/8
	5/8	hard	Angle grinders 115 / 125, spindle M14	835869	13,300	1	CC-H-GT 115-125 M14
		hard	Angle grinders 115 / 125, spindle 5/8"	841419	13,300	1	CC-H-GT 115-125 5/8
125	M14	medium	Angle grinders 125, spindle M14	223413	12,200	1	CC-GT 125 M14
		medium	Angle grinders 125, spindle 5/8"	223468	12,200	1	CC-GT 125 5/8
	5/8	hard	Angle grinders 125, spindle M14	223451	12,200	1	CC-H-GT 125 M14
		hard	Angle grinders 125, spindle 5/8"	223475	12,200	1	CC-H-GT 125 5/8
180	M14	medium	Angle grinders 180, spindle M14	725788	8,500	1	CC-GT 180 M14
		medium	Angle grinders 180, spindle 5/8"	725795	8,500	1	CC-GT 180 5/8



Ceramic oxide grain CO-COOL abrasive

Fibre discs FS

Ceramic oxide grain CO-COOL type

Ideally suited for coarse grinding work and step-by-step fine grinding.

Advantages:

- High profitability thanks to long tool life and very high stock removal rate.
- Consistent surface finish thanks to high-quality abrasives.
- Optimum adaptation to contours thanks to high flexibility.

Applications:

levelling, deburring, surface work, work on edges, work on weld seams, step-by-step fine grinding

Recommendations for use:

- Use fibre discs conforming to ISO 15636 with backing pads on commercially available angle grinders.
- Use grinding oil which is suitable for the material in order to considerably increase the tool life and abrasive performance of the tools. More detailed information and ordering data for grinding oils can be found in our Tool Manual 23, catalogue section 4, page 155 or on www.pferd.com.

Ordering notes:

- Please order backing pads separately. More detailed information and ordering data for backing pads can be found on page 6.
- When ordering, please state the EAN or the full description.

Safety notes:

- The maximum permitted peripheral speed is 80 m/s.
- For safety reasons, the specified maximum permitted rotational speed must never be exceeded.

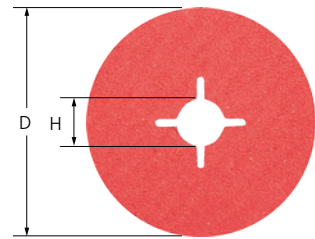

D [mm]	H [mm]	Grit size							Max. RPM		Description
		24	36	50	60	80	100	120			
EAN 4007220											
100	16	899625	832998	833001	833018	833025	-	908129	15,300	25	FS 100-16 CO-COOL ...
115	22	696880	696897	696903	696910	696927	696934	696941	13,300	25	FS 115-22 CO-COOL ...
125	22	696958	696965	696972	696989	696996	697009	697016	12,200	25	FS 125-22 CO-COOL ...
180	22	697023	697030	697047	697054	697061	697078	697085	8,500	25	FS 180-22 CO-COOL ...



Here you will find the entire range of fibre discs.



Ceramic oxide grain CO-COOL abrasive

Backing pads

GT, H-GT and HT-GT types

Three different backing pad types are supplied for using fibre discs on commercially available angle grinders.

GT:

Backing pad for optimum adaptation to contours thanks to high flexibility. According to ISO 15636.

H-GT:

High-performance backing pad with a long tool life thanks to abrasion-resistant, glass-fibre-reinforced plastic. Impresses with particularly cool grinding due to radially arranged cooling fins, and high fibre disc stock removal rate due to sturdy, rigid design.

HT-GT:

Flexible and extremely temperature-resistant backing pad with a long tool life due to the highly temperature-resistant material. Enables high-precision work thanks to high flexibility. According to ISO 15636.



Ordering notes:

- The matching clamping nut is included.

Accessories:

- Clamping nuts for backing pads GT

Suitable for tool dia. [mm]	Thread	Suitable for machine types	EAN 4007220	Max. RPM		Description
GT						
100	M10	Angle grinders 100, spindle M10	100998	15,300	1	GT 100 MF M10
115	M10	Angle grinders 115, spindle M10	668047	13,300	1	GT 115 MF M10
	M14	Angle grinders 115, spindle M14	668054	13,300	1	GT 115 MF M14
125	M14	Angle grinders 125, spindle M14	668061	12,200	1	GT 125 MF M14
150	M14	Angle grinders 150, spindle M14	668078	10,200	1	GT 150 MF M14
180	M14	Angle grinders 180, spindle M14	668085	8,500	1	GT 180 MF M14
H-GT, high-performance backing pad						
115	M14	Angle grinders 115, spindle M14	668115	13,300	1	H-GT 115 MF M14
125	M14	Angle grinders 125, spindle M14	668122	12,200	1	H-GT 125 MF M14
180	M14	Angle grinders 180, spindle M14	668139	8,500	1	H-GT 180 MF M14
HT-GT, temperature-resistant backing pad						
115	M14	Angle grinders 115, spindle M14	032398	13,300	1	HT-GT 115 MF M14
125	M14	Angle grinders 125, spindle M14	032404	12,200	1	HT-GT 125 MF M14
180	M14	Angle grinders 180, spindle M14	032381	8,500	1	HT-GT 180 MF M14



Ceramic oxide grain CO-COOL abrasive

COMBIDISC abrasive discs CD, CDR

Ceramic oxide grain CO-COOL type

Ideally suited for coarse machining and step-by-step fine grinding.

Advantages:

- High profitability thanks to quick tool changes.
- Great convenience thanks to simple handling and low-vibration working.
- No operational disruptions caused by sticking, slipping or disengaging.

Applications:

roughening, levelling, deburring, surface work, work on edges, polishing, cleaning, sharpening, work on weld seams, structuring surfaces, step-by-step fine grinding

Recommendations for use:

- Use COMBIDISC grinding tools with arbors or abrasive disc holders on flexible shaft drives with angle handpieces, compressed air or electric angle grinders.
- Use grinding oil which is suitable for the material in order to considerably increase the tool life and abrasive performance of the tools. More detailed information and ordering data for grinding oils can be found in our Tool Manual 23, catalogue section 4, page 155 or on www.pferd.com.

Ordering notes:

- Please order arbors or COMBIDISC abrasive disc holders separately. More detailed information and ordering data can be found on page 10.
- When ordering, please state the EAN or the full description.

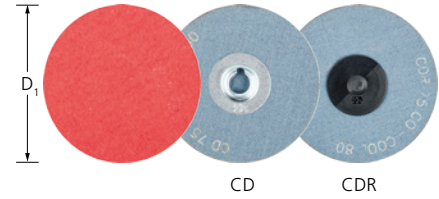

Safety notes:

- The maximum permitted peripheral speed is 50 m/s.
- For safety reasons, the specified maximum permitted rotational speed must never be exceeded.

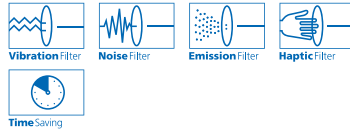

PFERDVALUE:



D ₁ [mm]	Grit size					Opt. RPM		Description
	24	36	60	80	120			
EAN 4007220								
System CD 								
38	770672	770689	770696	770702	770719	5,000–16,000	100	CD 38 CO-COOL ...
50	617922	617298	617304	617311	771365	3,800–13,000	100	CD 50 CO-COOL ...
75	617939	617328	617335	617342	771372	2,500–9,000	50	CD 75 CO-COOL ...
System CDR 								
38	778593	778609	778616	778623	778630	5,000–16,000	100	CDR 38 CO-COOL ...
50	778661	778678	778685	778692	778708	3,800–13,000	100	CDR 50 CO-COOL ...
75	778715	778722	778739	778746	778753	2,500–9,000	50	CDR 75 CO-COOL ...

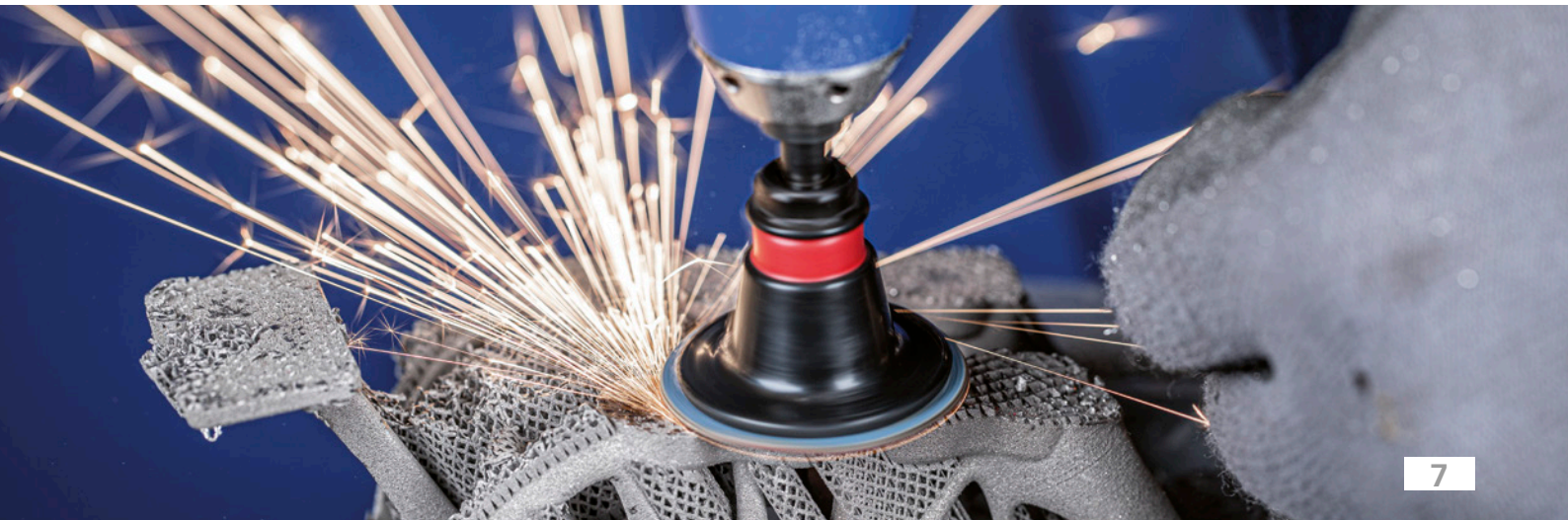

Ceramic oxide grain CO-COOL abrasive

COMBIDISC abrasive discs CDF, CDFR

Midget fibre discs Ceramic oxide grain CO-COOL type

Exceptionally well-suited to surface and edge grinding. The fibre backing strengthens the abrasive disc and improves stock removal.

The COMBIDISC product range contains a wide selection of midget fibre discs with ceramic oxide grain CO-COOL abrasive for coarse machining and step-by-step fine grinding.

Advantages:

- High profitability thanks to quick tool changes.
- Great convenience thanks to simple handling and low-vibration working.
- No operational disruptions caused by sticking, slipping or disengaging.

Applications:

roughening, levelling, deburring, surface work, work on edges, polishing, cleaning, sharpening, work on weld seams, structuring surfaces, step-by-step fine grinding

Recommendations for use:

- Use COMBIDISC grinding tools with arbors or abrasive disc holders on flexible shaft drives with angle handpieces, compressed-air or electric angle grinders.
- Use grinding oil which is suitable for the material in order to considerably increase the tool life and abrasive performance of the tools. More detailed information and ordering data for grinding oils can be found in our Tool Manual 23, catalogue section 4, page 155 or on www.pferd.com.

Ordering notes:



- Please order arbors or COMBIDISC abrasive disc holders separately. More detailed information and ordering data can be found on page 10.
- When ordering, please state the EAN or the full description.

Safety notes:

- The maximum permitted peripheral speed is 50 m/s.
- For safety reasons, the specified maximum permitted rotational speed must never be exceeded.

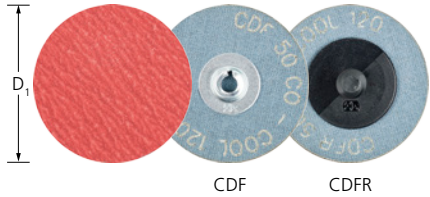
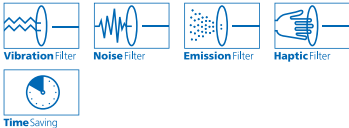
PFERDVALUE:



D ₁ [mm]	Grit size				Opt. RPM		Description
	36	50	80	120			
EAN 4007220							
System CD 							
50	778876	778883	778890	779156	3,800–13,000	100	CDF 50 CO-COOL ...
75	779163	779170	779187	779194	2,500–9,000	50	CDF 75 CO-COOL ...
System CDR 							
50	779200	779217	779224	779231	3,800–13,000	100	CDFR 50 CO-COOL ...
75	779255	779262	779279	779286	2,500–9,000	50	CDFR 75 CO-COOL ...



Ceramic oxide grain CO-COOL abrasive

COMBIDISC abrasive discs CDR

Midget fibre discs RS ceramic oxide grain CO-COOL type

RS type COMBIDISC abrasive discs are outstandingly well suited for weld dressing of backwards repair welds, e.g. in cases, slots and grooves on engines and for processing welded-on combustor plates. Unlike on conventional abrasive discs, the abrasive coating is on the under-side of the tool, which allows backwards working.

Advantages:

- Ideal for use in extremely difficult to reach locations.
- Convenient and safe backward working.
- High profitability thanks to quick tool changes.
- Great convenience thanks to simple handling and low-vibration working.
- No operational disruptions caused by sticking, slipping or disengaging.

Recommendations for use:

- Move the tool to the location to be worked. To grind, do not push it onto the surface, pull it towards yourself.
- Use COMBIDISC grinding tools with arbors or abrasive disc holders on flexible shaft drives with angle handpieces, compressed-air or electric angle grinders.
- To ensure optimum utilization of the grinding surface using the SBHR 20 or SBHR 25 abrasive disc holder.
- Always use the RS abrasive discs at the specified optimum rotational speed and do not adhere to the maximum permitted rotational speeds of the SBHR 20 or SBHR 25 holder.

- Use grinding oil which is suitable for the material in order to considerably increase the tool life and abrasive performance of the tools. More detailed information and ordering data for grinding oils can be found in our Tool Manual 23, catalogue section 4, page 155 or on www.pferd.com.

Ordering notes:

- Please order arbors or COMBIDISC abrasive disc holders separately. More detailed information and ordering data can be found on page 10.
- When ordering, please state the EAN or the full description.

Safety notes:

- The maximum permitted peripheral speed is 50 m/s.
- For safety reasons, the specified maximum permitted rotational speed must never be exceeded.

PFERDVALUE:

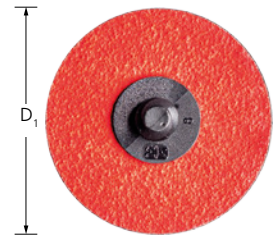
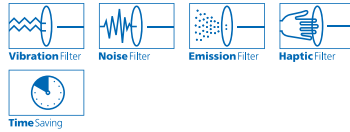

D ₁ [mm]	Grit size			Opt. RPM		Description
	50	80	120			
	EAN 4007220					

System CDR



38	074671	222829	222843	10,000–16,000	100	CDFR 38 CO-COOL ... RS
50	241783	241790	241806	3,800–13,000	100	CDFR 50 CO-COOL ... RS
75	241813	241820	241844	2,500–9,000	50	CDFR 75 CO-COOL ... RS



Ceramic oxide grain CO-COOL abrasive COMBIDISC abrasive disc holders

SBH and SBHR types

Matching arbors for COMBIDISC grinding tools. Available in three different hardness grades.

Ordering notes:

- The different hardness grades are colour-coded:
W (soft) – grey;
M (medium) – blue;
H (hard) – red
- Please complete the description with the desired hardness grade.

PFERDVALUE:

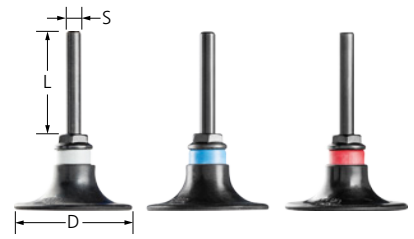
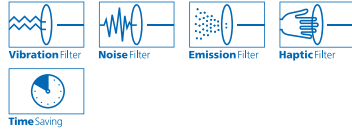

D [mm]	S [mm]	L [mm]	Hardness			Max. RPM		Description
			W (soft)	M (medium)	H (hard)			
EAN 4007220								

CD system

20	6	40	-	265901	-	47,500	1	SBH 20 ...
25	6	40	-	266755	-	38,000	1	SBH 25 ...
38	6	40	266762	266779	266786	25,000	1	SBH 38 ...
50	6	40	266793	266809	266816	19,000	1	SBH 50 ...
75	6	40	266823	266830	266847	12,500	1	SBH 75 ...

CDR system

20	6	40	-	776315	-	47,500	1	SBHR 20 ...
25	6	40	-	776322	-	38,000	1	SBHR 25 ...
38	6	40	776346	597057	776339	25,000	1	SBHR 38 ...
50	6	40	776360	597064	776353	19,000	1	SBHR 50 ...
75	6	40	776384	597071	776377	12,500	1	SBHR 75 ...

Adapters:

The shank of the abrasive disc holders can be replaced by suitable adapters. This enables the abrasive disc holder to be mounted directly to the drive spindle of the tool drive.

The following adapters are available:



AF 14-1/4 CD,
(EAN 4007220**302026**)
Female thread M14,
male thread 1/4-20 UNC.
Suitable for drives with
spindle M14.



SPV-20 CD 1/4-20 UNC,
(EAN 4007220**333167**)
Female thread 1/4-20 UNC,
male thread 1/4-20 UNC.
Suitable for drives with
spindle 1/4-20 UNC, e.g. for
PW 3/120 DH.



AF M5 CD 1/4-20 UNC
(EAN 4007220**064702**)
Male thread M5,
male thread 1/4-20 UNC.
Suitable for cordless angle
grinder, dia. 75, with spindle
M5 (female thread).



Here you will find further details and useful information about the wide range of COMBIDISC tools.

Ceramic oxide grain CO-COOL abrasive

Short belts BA

Ceramic oxide grain CO-COOL type

The range of short belts with ceramic oxide grain CO-COOL abrasive is tailored to the belt grinders that are commonly found on the market and offers the optimum tool for coarse grinding work and step-by-step fine grinding.

Advantages:

- High profitability thanks to high abrasive performance and long tool life.
- High tear strength with optimum flexibility.
- Consistent work results thanks to very high grain adhesion.

Applications:

levelling, deburring, work on edges, sharpening, work on weld seams, step-by-step fine grinding

Recommendations for use:

- Use grinding oil which is suitable for the material in order to considerably increase the tool life and abrasive performance of the tools. More detailed information and ordering data for grinding oils can be found in our Tool Manual 23, catalogue section 4, page 155 or on www.pferd.com.

Ordering notes:

- When ordering, please state the EAN or the full description.

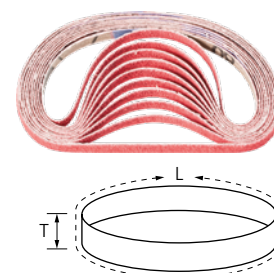

L [mm]	T [mm]	Grit size				Acc. to ISO standards		Description
		40	60	80	120			
		EAN 4007220						
305	6	799215	799222	799239	799246	-	100	BA 6/305 CO-COOL ...
	9	799352	799369	799376	799383	-	100	BA 9/305 CO-COOL ...
	12	799444	799451	799468	799475	-	100	BA 12/305 CO-COOL ...
330	10	799390	799406	799413	799420	2976	100	BA 10/330 CO-COOL ...
	12	799482	799499	799505	799536	-	100	BA 12/330 CO-COOL ...
450	35	949887	949894	949917	949924	2976	20	BA 35/450 CO-COOL ...
	50	949931	949948	949955	949962	2976	20	BA 50/450 CO-COOL ...
457	13	799628	799635	799642	799659	2976	100	BA 13/457 CO-COOL ...
480	16	799666	799673	799680	799697	-	50	BA 16/480 CO-COOL ...
	20	799741	799758	799772	799789	2976	20	BA 20/480 CO-COOL ...
480	25	799833	799840	799857	799864	2976	20	BA 25/480 CO-COOL ...
	6	799260	799277	799284	799307	2976	100	BA 6/520 CO-COOL ...
520	12	799543	799550	799567	799574	-	100	BA 12/520 CO-COOL ...
	16	799703	799710	799727	799734	-	50	BA 16/520 CO-COOL ...
	20	799796	799802	799819	799826	2976	20	BA 20/520 CO-COOL ...
533	30	799871	799888	799895	799901	-	20	BA 30/533 CO-COOL ...
610	6	799314	799321	799338	799345	2976	100	BA 6/610 CO-COOL ...
	12	799581	799598	799604	799611	-	100	BA 12/610 CO-COOL ...
	30	799918	799925	799932	799949	-	10	BA 30/610 CO-COOL ...



Ceramic oxide grain CO-COOL abrasive

Long belts BA

Ceramic oxide grain CO-COOL type

The range of long belts with ceramic oxide grain CO-COOL abrasive is tailored to the belt grinders that are commonly found on the market and offers the optimum tool for coarse grinding work and step-by-step fine grinding.

Advantages:

- High profitability thanks to high abrasive performance and long tool life.
- High tear strength with optimum flexibility.
- Consistent work results thanks to very high grain adhesion.

Applications:

levelling, deburring, work on edges, sharpening, work on weld seams, step-by-step fine grinding

Recommendations for use:

- Use grinding oil which is suitable for the material in order to considerably increase the tool life and abrasive performance of the tools. More detailed information and ordering data for grinding oils can be found in our Tool Manual 23, catalogue section 4, page 155 or on www.pferd.com.

Ordering notes:

- When ordering, please state the EAN or the full description.

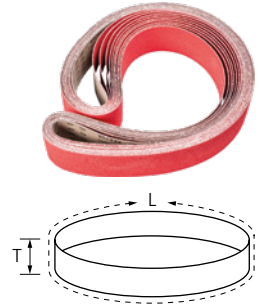

L [mm]	T [mm]	Grit size						Acc. to ISO standards		Description
		36	40	50	60	80	120			
EAN 4007220										
2,000	50	950173	950333	950357	950371	950401	950425	2976	10	BA 50/2000 CO-COOL ...
	75	950449	950470	950494	950500	950517	950524	2976	10	BA 75/2000 CO-COOL ...
2,500	75	950562	950579	950586	950593	950609	950616	2976	10	BA 75/2500 CO-COOL ...

 Here you will find the entire range of short and long abrasive belts.

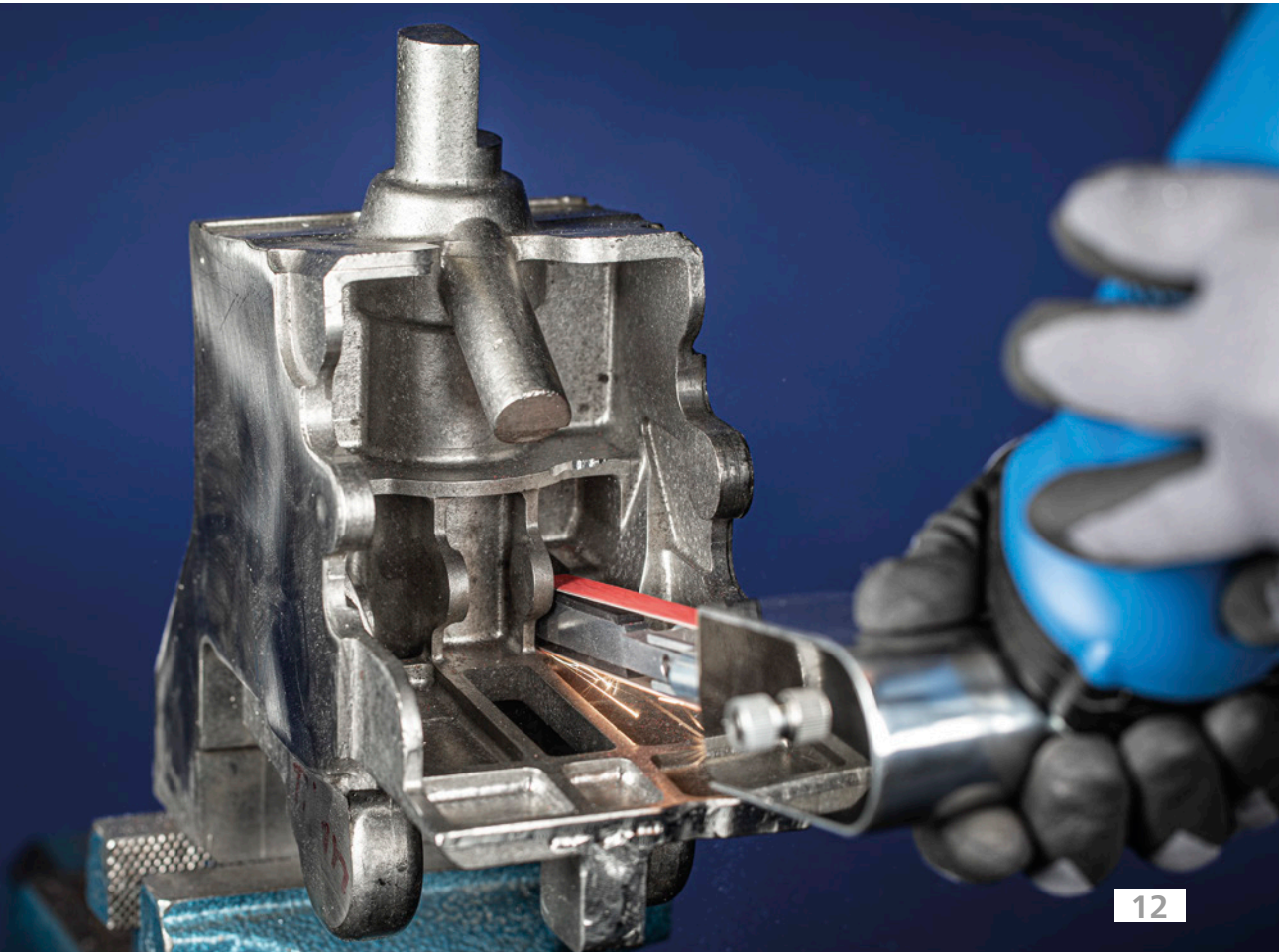

Ceramic oxide grain CO-COOL abrasive

Belts for pneumatic drums

Ceramic oxide grain CO-COOL type

The range of abrasive spiral bands for pneumatic grinding drum ceramic oxide grain CO-COOL type offers the best tool solution for a lot of applications. Suitable for coarse to fine grinding.

Advantages:

- Excellent economic efficiency due to high abrasive performance and long tool life.
- High tear strength with optimum flexibility.
- The rubber tube of the grinding drum yields flexibly under higher contact pressure, which reduces heat build-up and wear of the abrasive belts.

Applications:

structuring surfaces, polishing, step-by-step fine grinding

Ordering notes:

- When ordering, please state the EAN or the full description.

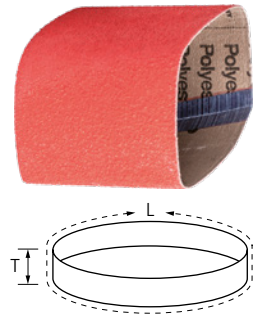

L [mm]	T [mm]	Grit size				Description
		40	60	80	120	
EAN 4007220						
282	100	149300	786307	788295	786314	5 BA 100/282 CO-COOL ...

Pneumatic drums

Pneumatic drums

The pneumatic grinding drum is suitable for short belts with a width of 100 mm and a length of 282 mm. The rubber tube of the grinding drum yields under higher contact pressure, which is why the abrasive belt adapts very well to the surface to be machined and the contact area increases.

Advantages:

- The rubber tube of the grinding drum yields flexibly under higher contact pressure, which reduces heat build-up and wear of the abrasive belts.

Recommendations for use:

- The air pressure of the pneumatic drum should be adjusted at the beginning of the grinding or polishing process.
 - The drum must be pumped up at least so far that the belts do not slip.
 - Use an air pump or compressed air gun for this purpose.
- To easily change the abrasive or polishing belts, discharge the air from the drum and refill after changing the belt.

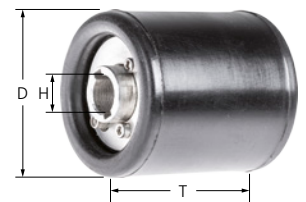

Suitable for short belts [mm]	D [mm]	T [mm]	H [mm]	EAN 4007220	Max. RPM	Description
100 x 282	90	100	19	158142	3,800	1 PSW 90x100

Ceramic oxide grain CO-COOL abrasive

Abrasive spiral bands bulk pack GSB

Ceramic oxide grain CO-COOL type

Abrasive spiral bands ceramic oxide grain CO-COOL type are the best tool solution for every application, from fine grinding through to aggressive grinding.

The packaging size is ideally suited to industrial requirements.

Advantages:

- Abrasive spiral band fits securely on the rubber drum holder as the holder expands during use.
- Outstanding tool life thanks to special manufacturing process – even under the toughest work conditions.
- Highest possible profitability thanks to particularly high stock removal and aggressiveness of the abrasive.

Applications:

roughening, levelling, deburring, surface work, work on edges, sharpening, work on weld seams, step-by-step fine grinding

Recommendations for use:

- To change the abrasive spiral bands easily, raise and lower them while turning slightly to the right. When doing so, leave the rubber drum holder engaged in the tool drive.
- Adhere to the minimum speed for the rubber drum holder to ensure that the abrasive spiral band fits securely.
- For best performance, use with a recommended cutting speed of 20–30 m/s.

- Use grinding oil which is suitable for the material in order to considerably increase the tool life and abrasive performance of the tools. More detailed information and ordering data for grinding oils can be found in our Tool Manual 23, catalogue section 4, page 155 or on www.pferd.com.

Ordering notes:

- Please order rubber drum holders separately.
- When ordering, please state the EAN or the full description.

Safety notes:

- The maximum permitted peripheral speed is 30 m/s.
- For safety reasons, the specified maximum permitted rotational speed must never be exceeded.
- Do not allow abrasive spiral bands to protrude beyond the rubber drum holder.

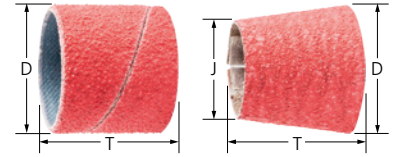

D [mm]	J [mm]	T [mm]	Grit size				Opt. RPM		Description
			36	60	80	120			
EAN 4007220									

Cylindrical shape

13	-	25	-	088074	092415	088227	30,000–44,000	100	GSB 1325 CO-COOL ...
15	-	30	-	772195	772201	772218	26,000–36,000	100	GSB 1530 CO-COOL ...
19	-	25	088234	088333	088340	088432	20,000–30,000	100	GSB 1925 CO-COOL ...
22	-	20	-	772225	772232	772249	18,000–26,000	100	GSB 2220 CO-COOL ...
25	-	25	088456	772256	772263	772270	16,000–22,900	100	GSB 2525 CO-COOL ...
30	-	30	772287	772294	772317	772331	13,000–19,100	100	GSB 3030 CO-COOL ...
38	-	25	088494	088500	088579	088586	10,000–15,900	100	GSB 3825 CO-COOL ...
45	-	30	772355	772362	772393	772409	8,500–12,700	100	GSB 4530 CO-COOL ...
51	-	25	088661	088678	088753	088760	7,500–11,200	100	GSB 5125 CO-COOL ...
60	-	30	772416	772423	772430	772447	6,500–9,500	100	GSB 6030 CO-COOL ...

Conical shape

20	14	63	950302	950319	950326	950340	19,000–26,000	100	GSB 201463 CO-COOL ...
29	22	30	950364	950388	950395	950418	13,000–19,100	100	GSB 292230 CO-COOL ...
36	22	60	950432	950456	950463	950487	10,000–15,900	100	GSB 362260 CO-COOL ...

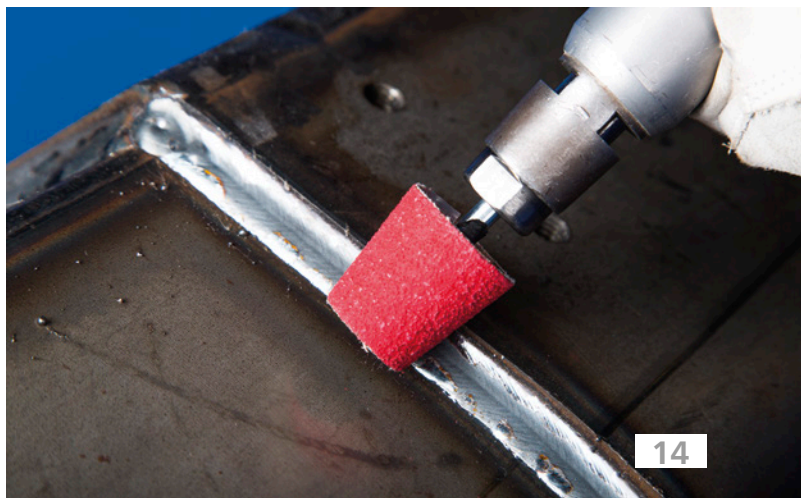
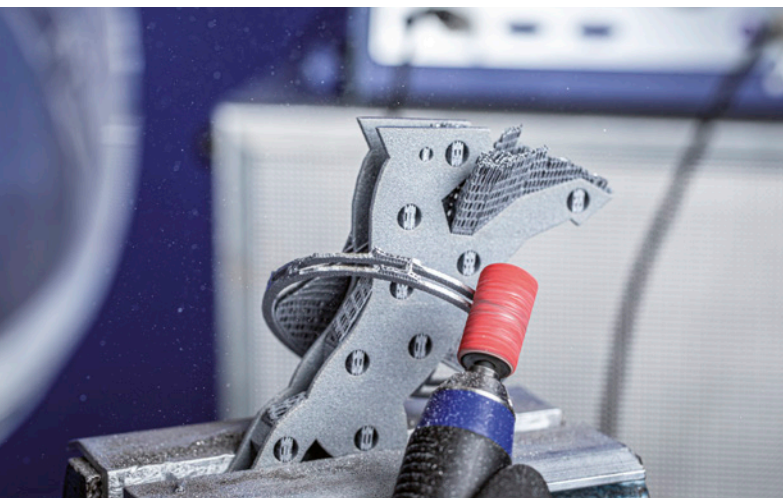

Ceramic oxide grain CO-COOL abrasive

Rubber drum holders GK

Conical and cylindrical types

Matching rubber drum holder for conical and cylindrical abrasive spiral bands.

Rubber drum holders marked "H" are the harder type and permit grinding at higher contact pressure. They are extremely well-suited to work on weld seams.

Advantages:

- Abrasive spiral band fits securely on the rubber drum holder as the holder expands during use.

Recommendations for use:

- To change the abrasive spiral bands easily, raise and lower them while turning slightly to the right. When doing so, leave the rubber drum holder engaged in the tool drive.
- Adhere to the minimum speed for the rubber drum holder to ensure that the abrasive spiral band fits securely.
- For best performance, use with a recommended cutting speed of 20–30 m/s.

Safety notes:

- The maximum permitted peripheral speed is 30 m/s.
- For safety reasons, the specified maximum permitted rotational speed must never be exceeded.
- Do not allow abrasive spiral bands to protrude beyond the rubber drum holder.

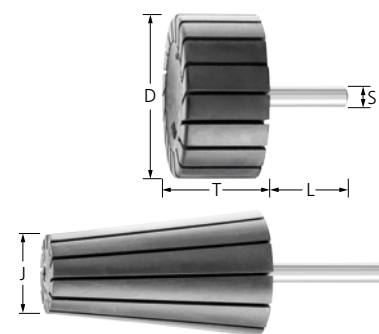

D [mm]	J [mm]	T [mm]	S [mm]	L [mm]	Hardness [Shore A]	EAN 4007220	Acc. to ISO standards	Max. RPM	Minimum rotational speed [RPM]		Description
--------	--------	--------	--------	--------	--------------------	-------------	-----------------------	----------	--------------------------------	---	-------------

Cylindrical shape

4	-	10	3	40	65-70	146729	-	55,000	30,000	5	GK 0410/3
			6	40	65-70	146712	-	55,000	30,000	5	GK 0410/6
6	-	10	3	40	65-70	146743	-	55,000	30,000	5	GK 0610/3
			6	40	65-70	146736	-	55,000	30,000	5	GK 0610/6
8	-	10	3	40	65-70	146767	-	55,000	30,000	5	GK 0810/3
			6	40	65-70	146750	-	55,000	30,000	5	GK 0810/6
10	-	10	6	35	65-70	146774	15637-1	44,000	30,000	5	GK 1010/6
		20	6	35	65-70	146781	15637-1	44,000	30,000	5	GK 1020/6
13	-	10	6	35	65-70	146798	-	44,000	30,000	5	GK 1310/6
			25	6	35	65-70	146804	-	44,000	30,000	5
15	-	10	6	35	65-70	146811	15637-1	36,000	26,000	5	GK 1510/6
			30	6	35	65-70	146828	15637-1	36,000	26,000	5
19	-	25	6	35	65-70	146835	-	30,000	20,000	5	GK 1925/6
22	-	20	6	35	65-70	146842	15637-1	26,000	18,000	5	GK 2220/6
						80	15637-1	26,000	18,000	5	GK 2220/6 H
25	-	25	6	35	65-70	146866	-	22,900	16,000	5	GK 2525/6
30	-	20	6	35	65-70	146873	15637-1	19,100	13,000	5	GK 3020/6
						146880	15637-1	19,100	13,000	5	GK 3030/6
						80	15637-1	19,100	13,000	5	GK 3030/6 H
38	-	25	6	35	65-70	146903	-	15,900	10,000	5	GK 3825/6
45	-	30	6	35	65-70	146927	15637-1	12,700	8,500	5	GK 4530/6
						80	15637-1	12,700	8,500	5	GK 4530/6 H
51	-	25	6	35	65-70	146941	-	11,200	7,500	5	GK 5125/6
60	-	30	6	35	65-70	146958	15637-1	9,500	6,500	5	GK 6030/6
			8	35	65-70	146965	15637-1	9,500	6,500	5	GK 6030/8
75	-	30	8	35	65-70	146972	15637-1	7,600	5,000	5	GK 7530/8
100	-	40	8	35	65-70	146989	15637-1	5,700	4,000	5	GK 10040/8

Conical shape

20	14	63	6	40	65-70	147078	-	26,000	19,000	5	GK 201463/6
29	22	30	6	40	65-70	147085	-	19,100	13,000	5	GK 292230/6
36	22	60	6	40	65-70	147092	-	15,900	10,000	5	GK 362260/6

Ceramic oxide grain CO-COOL abrasive

POLIROLL cartridge rolls PR and arbors BO

Ceramic oxide grain CO-COOL type

POLIROLL tools are suited for work in hard-to-access places. They consist of spirally wound, coated abrasives. The abrasive grain is embedded in the resinoid coating on the sturdy backing material, which achieves the best possible abrasive performance.

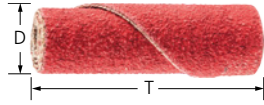

Advantages:

- Constantly high abrasive performance throughout the entire tool life thanks to fresh abrasive grain being constantly freed up in operation.
- Secure fit of the POLIROLL when in use due to self-tensioning provided by grooved, conical arbor.
- Easy tool changing.

Materials that can be worked:

aluminium, cobalt-based alloys, nickel-based alloys (e.g. Inconel and Hastelloy), titanium, stainless steel (INOX)

Applications:

levelling, deburring, work on edges, sharpening, work on weld seams, step-by-step fine grinding

Recommendations for use:

- Grind with the tip instead of the flat surface so as not to damage the bond through exposure to heat.
- Mount POLIROLL with the bonded side facing towards the arbor.
- Use grinding oil which is suitable for the material in order to considerably increase the tool life and abrasive performance of the tools. More detailed information and ordering data for grinding oils can be found in our Tool Manual 23, catalogue section 4, page 155 or on www.pferd.com.

Ordering notes:

- When ordering, please state the EAN or the full description.

Safety notes:

- The maximum permitted peripheral speed is 11 m/s.
- For safety reasons, the specified maximum permitted rotational speed must never be exceeded.

D [mm]	T [mm]	Grit size			Opt. RPM	Max. RPM	Suitable arbors		Description
		60	80	120					
EAN 4007220									
6	25	803264	803271	803288	20,000	25,000	BO 3-18-3, BO 6-18-3	50	PR 0625 CO-COOL ...
	35	803295	803301	803318	20,000	25,000	BO 6-24-3	50	PR 0635 CO-COOL ...
9	25	803325	803332	803349	15,000	23,000	BO 6-18-3	50	PR 0925 CO-COOL ...
	35	803356	803363	803370	15,000	23,000	BO 6-24-3	50	PR 0935 CO-COOL ...
12	25	803387	803394	803400	12,000	17,000	BO 6-18-3	50	PR 1225 CO-COOL ...
	35	803424	803431	803448	12,000	17,000	BO 6-24-3	50	PR 1235 CO-COOL ...

Arbors BO

Arbors for POLIROLL and POLICO tools.

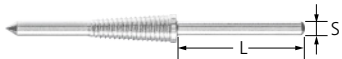

Advantages:

- Tool can be changed without unclamping the arbor from the tool drive collet.

Ordering notes:

- Arbor BO 6-50-8 – matching PCO 1050. The cone of the clamping piece is 5°.

Suitable for	S [mm]	L [mm]	EAN 4007220		Description
PR 0625, PRK 1025	3	27	152171	1	BO 3-18-3
PR 0625, PR 0925, PR 1225, PRK 1025, PRK 1225	6	30	152188	1	BO 6-18-3
PR 0635, PR 0935, PR 1235, PRK 1235, PRK 1535	6	30	152195	1	BO 6-24-3
PR 1835	6	30	152201	1	BO 6-25-5
PR 1850	6	30	152218	1	BO 6-30-5
PCO 1050	6	30	152232	1	BO 6-50-8



Ceramic oxide grain CO-COOL abrasive

POLICAP abrasive caps and abrasive cap holders, shape WRC

Abrasive caps PC WRC

POLICAP tools have a seamless design, and the entire tool surface can be used.

POLICAP abrasive caps in cylindrical shape with radius end WRC (previously shape C).

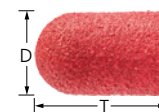

Advantages:

- Abrasive caps and spiral bands fit securely on the holder as it expands during use.
- High standards of shape accuracy and excellent fine grinding thanks to a special manufacturing process.
- Easy tool changing.

Applications:

levelling, surface work, step-by-step fine grinding

Recommendations for use:

- To change the abrasive caps and spiral bands easily, raise and lower them while turning slightly to the right. When doing so, leave the tool carrier engaged in the tool drive and fix in place.
- For best performance, use with a recommended cutting speed of 10–20 m/s.

Ordering notes:

- When ordering, please state the EAN or the full description.

Safety notes:

- The maximum permitted peripheral speed is 25 m/s.
- For safety reasons, the specified maximum permitted rotational speed must never be exceeded.

D [mm]	T [mm]	Grit size		Opt. RPM		Description
		80	120			
		EAN				
5	11	953938	953945	40,000	50	PC WRC 0511 CO-COOL ...
7	13	953952	953969	30,000	50	PC WRC 0713 CO-COOL ...
10	15	953976	954041	20,000	50	PC WRC 1015 CO-COOL ...
13	17	954058	954119	16,000	50	PC WRC 1317 CO-COOL ...
16	26	954126	954133	12,000	50	PC WRC 1626 CO-COOL ...

Abrasive cap holders PCT WRC

Matching POLICAP abrasive cap holder in cylindrical shape with radius end WRC (previously shape C).

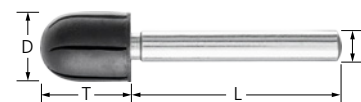

D [mm]	T [mm]	S [mm]	L [mm]	EAN 4007220	Max. RPM		Description
5	11	2.35	40	621820	30,000	5	PCT WRC 0511/2,35
		3	25	147160	95,000	5	PCT WRC 0511/3
7	13	2.35	40	621837	24,500	5	PCT WRC 0713/2,35
		3	25	147177	65,000	5	PCT WRC 0713/3
10	15	2.35	40	621844	17,500	5	PCT WRC 1015/2,35
		3	25	147184	45,000	5	PCT WRC 1015/3
13	17	2.35	40	621851	13,750	5	PCT WRC 1317/2,35
		6	40	147245	35,000	5	PCT WRC 1317/6
16	26	6	40	147252	30,000	5	PCT WRC 1626/6



Ceramic oxide grain CO-COOL abrasive

POLICAP abrasive caps and abrasive cap holders, shape KEL

Abrasive caps PC KEL

POLICAP tools have a seamless design, and the entire tool surface can be used.

POLICAP abrasive caps in conical shape with radius end KEL (previously shape L).

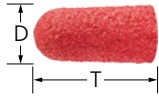

Advantages:

- Abrasive caps and spiral bands fit securely on the holder as it expands during use.
- High standards of shape accuracy and excellent fine grinding thanks to a special manufacturing process.
- Easy tool changing.

Applications:

levelling, surface work, step-by-step fine grinding

Recommendations for use:

- To change the abrasive caps and spiral bands easily, raise and lower them while turning slightly to the right. When doing so, leave the tool carrier engaged in the tool drive and fix in place.
- For best performance, use with a recommended cutting speed of 10–20 m/s.

Ordering notes:

- When ordering, please state the EAN or the full description.

Safety notes:

- The maximum permitted peripheral speed is 25 m/s.
- For safety reasons, the specified maximum permitted rotational speed must never be exceeded.

D [mm]	T [mm]	Grit size		Opt. RPM		Description
		80	120			
		EAN				
5	15	954140	954263	40,000	50	PC KEL 0515 CO-COOL ...
11	25	954164	954188	20,000	50	PC KEL 1125 CO-COOL ...
16	32	954195	954218	12,000	50	PC KEL 1632 CO-COOL ...
21	40	954225	954232	9,500	50	PC KEL 2140 CO-COOL ...

Abrasive cap holders PCT KEL

Matching POLICAP abrasive cap holder in conical shape with radius end KEL (previously shape L).

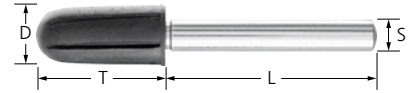

D [mm]	T [mm]	S [mm]	L [mm]	EAN 4007220	Max. RPM		Description
5	15	6	40	147283	95,000	5	PCT KEL 0515/6
11	25	6	40	147290	40,000	5	PCT KEL 1125/6
16	32	6	40	147306	30,000	5	PCT KEL 1632/6
21	40	6	40	147313	20,000	5	PCT KEL 2140/6



The whole POLICAP product range can be found in the brochure "POLICAP abrasive caps and spiral bands – Highest performance on all materials" on www.pferd.com.



PFERDVIDEO:

Learn more about the advantages of using POLICAP grinding tools.



Ceramic oxide grain CO-COOL abrasive

Mounted flap wheels F

Ceramic oxide grain CO-COOL type

On mounted flap wheels, the flaps made of coated abrasive are arranged radially around the tool axis in a fan-type structure. Their flexibility enables them to adapt perfectly to the contours of the workpiece. The abrasive grain is embedded in the sturdy, flexible cloth backing material by means of a resinoid bond.

Advantages:

- Optimum adaptation to contours thanks to high flexibility.
- Consistently high stock removal throughout the entire tool life as new, aggressive abrasive material is constantly freed up.
- Face-down use very close to edges and in corners is possible thanks to the flat, moulded-core design.

Applications:

levelling, deburring, surface work, work on weld seams, structuring surfaces, step-by-step fine grinding

Recommendations for use:

- For best performance, use with a recommended cutting speed of 15–20 m/s. This provides an ideal compromise between stock removal rate, surface quality, thermal load on the workpiece and tool wear.
- Use grinding oil which is suitable for the material in order to considerably increase the tool life and abrasive performance of the tools. More detailed information and ordering data for grinding oils can be found in our Tool Manual 23, catalogue section 4, page 155 or on www.pferd.com.

Ordering notes:

- When ordering, please state the EAN or the full description.

Safety notes:

- For safety reasons, the specified maximum permitted rotational speed must never be exceeded.
- The contact pressure has to be reduced significantly when the optimum rotational speed is exceeded.
- Safety is only guaranteed when:
 - The clamping length is at least 15 mm.
 - The specified maximum rotational speed is not exceeded with unsupported shank lengths.

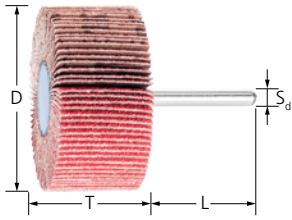

PFERDVALUE:



D [mm]	T [mm]	Grit size				Opt. RPM	Max. RPM		Description
		40	60	80	120				
EAN 4007220									

Shank dia. 6 x 40 mm [S_d x L]

20	10	-	065938	884751	884775	19,000	38,100	10	F 2010/6 CO-COOL ...
30	10	803738	803745	803752	803769	12,000	25,400	10	F 3010/6 CO-COOL ...
	15	803776	803783	803790	803806	12,000	25,400	10	F 3015/6 CO-COOL ...
	20	035009	035016	035023	962046	12,000	25,400	10	F 3020/6 CO-COOL ...
40	20	803813	803820	803837	803844	9,600	19,100	10	F 4020/6 CO-COOL ...
50	30	803868	803875	803899	803882	7,000	15,200	10	F 5030/6 CO-COOL ...
60	15	065945	065952	000137	065969	6,300	12,700	10	F 6015/6 CO-COOL ...
	30	803905	803912	803929	803936	6,300	12,700	10	F 6030/6 CO-COOL ...

 Here you will find further details and useful information about the wide range of mounted flap wheels.

Ceramic oxide grain CO-COOL abrasive

Unmounted flap wheels FR and arbor FR/VR

CO-COOL type

On unmounted flap wheels, the flaps made of coated abrasive are arranged radially around the tool axis in a fan-type structure. Their flexibility enables them to adapt perfectly to the contours of the workpiece. The abrasive grain is embedded in the sturdy, flexible cloth backing material by means of a resinoid bond.

Advantages:

- Optimum adaptation to contours thanks to high flexibility.
- Consistently high stock removal throughout the entire tool life as new, aggressive abrasive material is constantly freed up.
- Face-down use very close to edges and in corners is possible thanks to the special clamping system.

Applications:

levelling, deburring, surface work, work on weld seams, structuring surfaces, step-by-step fine grinding

Recommendations for use:

- For best performance, use with a recommended cutting speed of 15–30 m/s. This provides an ideal compromise between stock removal rate, surface quality, thermal load on the workpiece and tool wear.
- Use grinding oil which is suitable for the material in order to considerably increase the tool life and abrasive performance of the tools. More detailed information and ordering data for grinding oils can be found in our Tool Manual 23, catalogue section 4, page 155 or on www.pferd.com.
- For best performance, use a tool drive with 1,000–1,500 watts.

Ordering notes:

- Please order the matching arbor separately.
- Matching arbor for a diameter of 150 and 165 mm: FR/VR 12/25,4 (EAN 4007220479643)
- When ordering, please state the EAN or the full description.

Safety notes:

- Unmounted flap wheels are generally to be used with the matching clamping flanges.
- The maximum permitted peripheral speed is defined as follows:
 - Unmounted flap wheels = 50 m/s
- The contact pressure has to be reduced significantly when the optimum rotational speed is exceeded.
- For safety reasons, the specified maximum permitted rotational speed must never be exceeded.

PFERDVALUE:

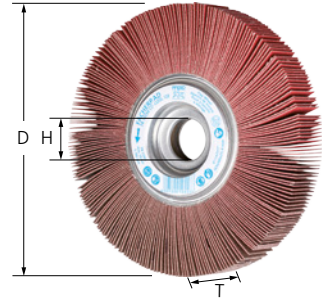

D [mm]	T [mm]	H [mm]	Grit size				Opt. RPM	Max. RPM		Description
			40	60	80	120				
EAN 4007220										
150	30	25.4	104859	104873	104880	104903	3,500	6,300	2	FR 15030/25,4 CO-COOL ...
	50	25.4	105467	105474	105481	105498	3,500	6,300	2	FR 15050/25,4 CO-COOL ...
165	30	25.4	105504	105511	105528	105535	3,200	5,700	2	FR 16530/25,4 CO-COOL ...
	50	25.4	105542	105559	105566	105573	3,200	5,700	2	FR 16550/25,4 CO-COOL ...

Type with clamping flange

For mounting PFERD unmounted flap wheels. The clamping flanges are designed to lie countersunk in the tool.

Advantages:

- Can be used face-down very close to edges and in angles thanks to special clamping system.

Ordering notes:

- Included in delivery: Arbor, clamping diameter of 12 mm, 2 flanges and matching screws (for different unmounted flap wheel widths).
- We manufacture arbors with morse cones on request.

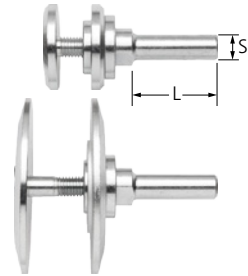

Suitable for tool dia. [mm]	Suitable for centre hole dia. [mm]	S [mm]	L [mm]	Clamping width [mm]	EAN 4007220		Description
100, 150, 165	25.4	12	40	25–50	479643	1	FR/VR 12/25,4 100-165

Ceramic oxide grain CO-COOL abrasive

Unmounted flap wheels for angle grinders

Ceramic oxide grain CO-COOL type

On unmounted flap wheels, the flaps made of coated abrasive are arranged radially around the tool axis in a fan-type structure. Their flexibility enables them to adapt perfectly to the contours of the workpiece. The abrasive grain is embedded in the sturdy, flexible cloth backing material by means of a resinoid bond.

The ideal tool for use on angle grinders in assembly shop operations.

Advantages:

- Can be mounted directly on the angle grinder without additional clamping devices.
- Optimum adaptation to contours thanks to high flexibility.
- Consistently high stock removal throughout the entire tool life as new, aggressive abrasive material is constantly freed up.
- Face-down use very close to edges and in corners is possible thanks to the special clamping system.

Applications:

levelling, deburring, surface work, work on weld seams, structuring surfaces, step-by-step fine grinding

Recommendations for use:

- For the best results, use at a recommended cutting speed of 40–50 m/s.
- Use grinding oil which is suitable for the material in order to considerably increase the tool life and abrasive performance of the tools. More detailed information and ordering data for grinding oils can be found in our Tool Manual 23, catalogue section 4, page 155 or on www.pferd.com.
- For best performance, use a tool drive with 1,000–1,500 watts.

Ordering notes:

- When ordering, please state the EAN or the full description.

Safety notes:

- Unmounted flap wheels are generally to be used with the matching clamping flanges.
- The maximum permitted peripheral speed is defined as follows:
 - Unmounted flap wheels for angle grinders = 80 m/s
- The contact pressure has to be reduced significantly when the optimum rotational speed is exceeded.
- For safety reasons, the specified maximum permitted rotational speed must never be exceeded.



PFERDVALUE:



D [mm]	T [mm]	Thread	Grit size				Opt. RPM	Max. RPM		Description
			40	60	80	120				
EAN 4007220										
115	20	M14	025611	025635	025642	025659	7,500	13,300	2	FR WS 11520 M14 CO-COOL ...
		5/8-11	025697	025703	025710	025727	7,500	13,300	2	FR WS 11520 5/8-11 CO-COOL ...
125	20	M14	025628	025666	025673	025680	6,850	12,200	2	FR WS 12520 M14 CO-COOL ...
		5/8-11	025734	025741	025765	025789	6,850	12,200	2	FR WS 12520 5/8-11 CO-COOL ...



Ceramic oxide grain CO-COOL abrasive

POLIVLIES grinding discs

Flap discs PVZ

These are particularly suited to work on large surfaces made from stainless steel (INOX).

Advantages:

- High profitability thanks to high abrasive performance and long tool life.
- Creates a consistently high surface quality throughout the entire tool life as new, sharp abrasive material is constantly freed up.
- Optimum adaptation to contours thanks to high flexibility.

Abrasive:

Abrasive flap: Ceramic oxide grain CO-COOL

Non-woven material: Aluminium oxide A

Available POLIVLIES grit sizes:

- 100 G = coarse (yellow-brown)
- 180 M = medium (red-brown)
- 240 F = fine (blue)

Materials that can be worked:

- Can be used on nearly all materials.

Recommendations for use:

- For the best results, use at a recommended cutting speed of 30–35 m/s.

Ordering notes:

- When ordering, please state the EAN or the full description.

Safety notes:

- For safety reasons, the specified maximum permitted rotational speed must never be exceeded.



D [mm]	T [mm]	H [mm]	Grit size			Opt. RPM	Max. RPM		Description
			CO-COOL 60 / A 100 G	CO-COOL 80 / A 180 M	CO-COOL 120 / A 240 F				
			EAN 4007220						
115	18	22.23	106334	106341	106358	5,000–5,800	13,300	5	PVZ 115 CO-COOL ...
125	18	22.23	106365	106372	106389	4,600–5,300	12,200	5	PVZ 125 CO-COOL ...



Ceramic oxide grain CO-COOL abrasive

POLIFAN flap discs – Performance Line SG ★★☆☆

CO-COOL SG STEELOX ★★☆☆

POLIFAN flap disc with particularly cool grinding for materials that are difficult to machine such as high-alloy and rust-resistant steel, nickel-based alloys or titanium alloys.

Performance Line SG tools achieve optimum results with maximum economic efficiency.

Advantages:

- The self-sharpening action of the ceramic oxide grain guarantees optimal results, even on materials that are difficult to machine.
- Less heat build-up in the workpiece compared with other flap discs.

Materials that can be worked:



steel, mill scale, stainless steel (INOX), nickel-based alloys (e.g. Inconel and Hastelloy), hard aluminium alloys

Applications:

surface grinding, weld dressing, chamfering, deburring

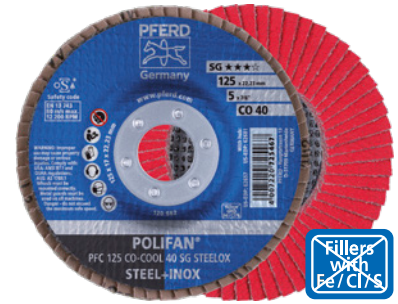
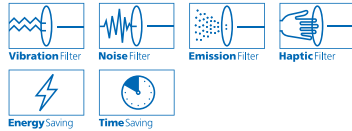
PFERDVALUE:



D [mm]	Grit size		H [mm]	Max. RPM		Description
	40	60				
	EAN 4007220					
Flat type PFF 						
115	725436	793145	22.23	13,300	10	PFF 115 CO-COOL ... SG STEELOX
125	725450	793152	22.23	12,200	10	PFF 125 CO-COOL ... SG STEELOX
180	725474	-	22.23	8,500	10	PFF 180 CO-COOL ... SG STEELOX
Conical type PFC 						
115	725443	793169	22.23	13,300	10	PFC 115 CO-COOL ... SG STEELOX
125	725467	793176	22.23	12,200	10	PFC 125 CO-COOL ... SG STEELOX
180	725481	-	22.23	8,500	10	PFC 180 CO-COOL ... SG STEELOX



Subject to technical modifications.

05/2022